

# THERMA V™ R32 R32 MONOBLOC S

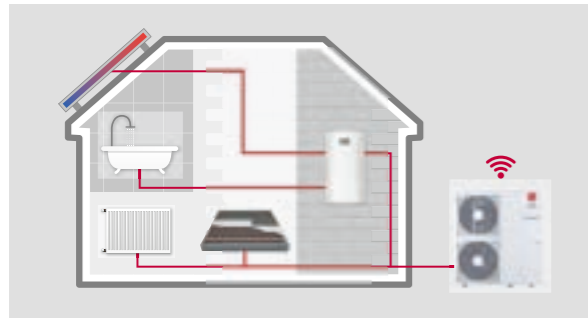

## Excellent Performance & Efficiency

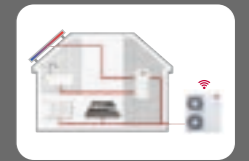

## User Convenience

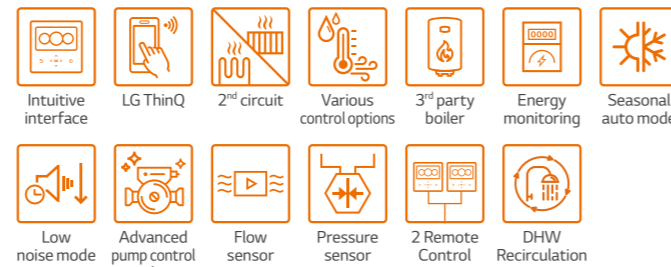

## Easy Installation & Maintenance

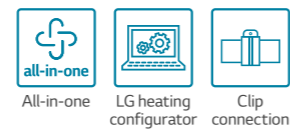

\* Detailed description for each function is presented on page 28 - 35.

## Energy Label

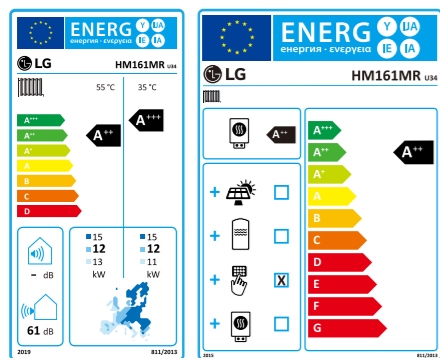

\* 16kW 10 model.  
\* A+++ to D scale.

## R32 Monobloc S Introduction

The THERMA V R32 Monobloc S is the 2nd generation of LG's R32 Monobloc series. As implied by "silence" and "supreme," it boasts reduced noise level and best performance in the THERMA V Series. Combining the indoor and outdoor as one module, it's also connected by only water piping eliminating the need for refrigerant piping. Furthermore, hydronic components like the plate heat exchanger, expansion tank, water pump, flow sensor, pressure sensor, air vent valves, and safety valve are conveniently situated inside the unit. The R32 Monobloc S provides excellent heating performance, especially at low ambient temperature while lowering its carbon emissions with R32.

## Key Components

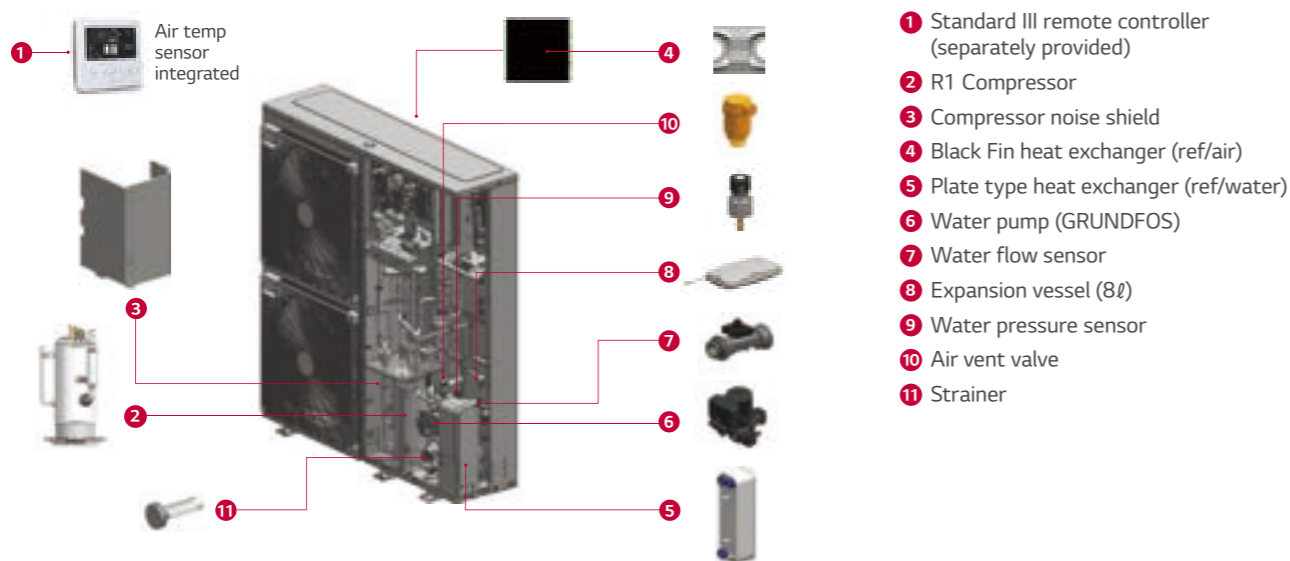

## Monobloc Concept

R32 Monobloc S is an all-in-one concept and reduced weight allows for quicker and easier installations.

- Additional hydronic components are included in the package
- Easier and quicker installation without refrigerant piping work

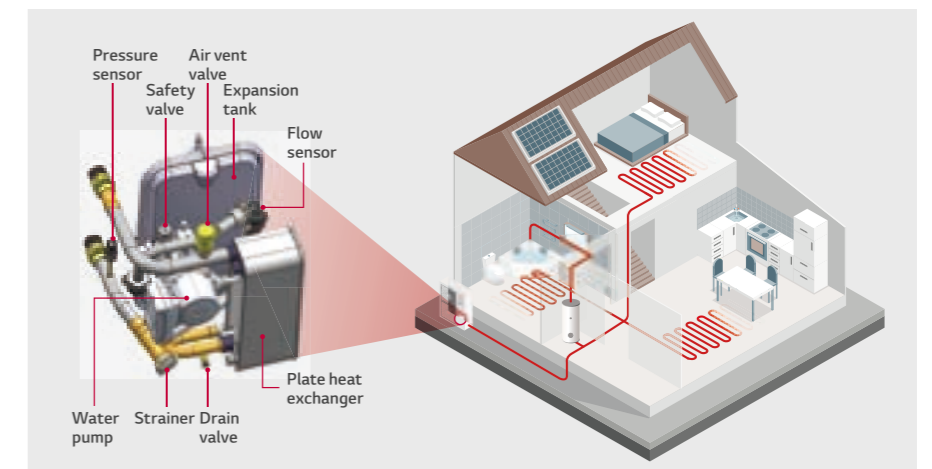

## Reduced Noise Level

R32 Monobloc S can be installed at the minimum of 4m away (based on 9kW model & Low noise mode) from neighboring houses while complying with German noise regulation.

Description		Germany	Austria	Switzerland	Netherlands
Sound Pressure Threshold	Day Time	50 dB (A) (06:00 - 22:00)	40 dB (A) (06:00 - 19:00)	40 dB (A) (07:00 - 19:00)	45 dB (A) (07:00 - 19:00)
	Evening	-	35 dB (A) (19:00 - 22:00)	-	-
	Night Time	35 dB (A) (22:00 - 06:00)	30 dB (A) (22:00 - 06:00)	35 dB (A) (19:00 - 07:00)	40 dB (A) (19:00 - 07:00)

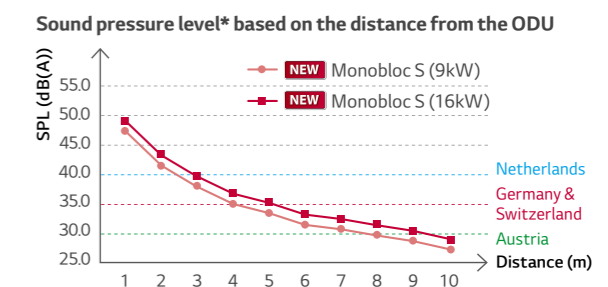
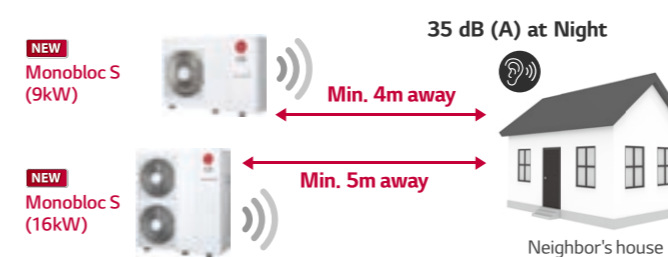

\* Sound Pressure Level is converted from Sound Power Level of Low Noise Mode based on Tonality penalty of 0dB and installation in free-field.

# PRODUCT SPECIFICATION

## R32 Monobloc S



HM051MR U44  
HM071MR U44  
HM091MR U44



### Features

- All-in-one outdoor unit
- SCOP up to 4.55 (Average climate / Low temp. application) : A+++  
SCOP up to 3.20 (Average climate / Mid temp. application) : A++
- COP up to 4.70 (Outdoor air 7°C / Leaving water 35°C)
- 100% heating capacity at -15°C OAT (@ LWT 35°C)
- Low sound level allowing high installation location flexibility
- Wide operation range (ambient : -25 ~ 35°C / water side : 15 ~ 65°C)
- Built-in water flow & pressure sensors to monitor real-time water circuit
- R32 refrigerant with reduced global warming potential (GWP)
- R1 compressor
- Improved heat exchanger design (New Black Fin)
- LG ThinQ
- KEYMARK / EHPA (for Germany) / MCS / EUROVENT certification

\* EHPA (for Austria and Switzerland) label under development

### Model Line-up

Capacity	Unit	Model Name		
		Capacity (kW)		
		5.5	7.0	9.0
1 Phase Model 220 - 240V, 1Ø, 50Hz	Monobloc Unit	HM051MR U44	HM071MR U44	HM091MR U44

### Seasonal Energy

Description	Unit	HM051MR U44	HM071MR U44	HM091MR U44		
Space Heating (According to EN14825)	Average Climate Water Outlet 35°C	SCOP	-	4.46	4.48	4.55
	Average Climate Water Outlet 55°C	Seasonal Space Heating Efficiency (η <sub>s</sub> )	%	175	176	179
		Seasonal Space Heating Eff. Class (A+++ to D Scale)	-	A+++	A+++	A+++
	Average Climate Water Outlet 55°C	SCOP	-	3.20	3.20	3.20
Seasonal Space Heating Efficiency (η <sub>s</sub> )		%	125	125	125	
Seasonal Space Heating Eff. Class (A+++ to D Scale)		-	A++	A++	A++	

### Nominal Capacity and Nominal Power Input

Description	OAT <sup>1)</sup> (DB)	LWT <sup>2)</sup> (DB)	Unit	HM051MR U44	HM071MR U44	HM091MR U44	
Nominal Capacity	Heating	7°C	35°C	kW	5.50	7.00	9.00
		7°C	55°C		5.50	5.50	5.50
		2°C	35°C		4.40	5.60	6.80
	Cooling	35°C	18°C		5.50	7.00	9.00
		35°C	7°C		5.50	7.00	9.00
		7°C	35°C		1.17	1.49	1.96
Nominal Power Input	Heating	7°C	55°C	kW	2.04	2.04	2.04
		2°C	35°C		1.22	1.58	1.94
		35°C	18°C		1.17	1.56	2.14
	Cooling	35°C	7°C		1.67	2.19	2.90
		7°C	35°C		4.70	4.70	4.60
		7°C	55°C		2.70	2.70	2.70
COP	Heating	2°C	35°C	W/W	3.60	3.55	3.50
		35°C	18°C		4.70	4.50	4.20
		35°C	7°C		3.30	3.20	3.10
EER	Cooling			W/W			

1) OAT : Outdoor Air Temperature  
2) LWT : Leaving Water Temperature

### Product Specification

Technical Specification				Unit	HM051MR U44	HM071MR U44	HM091MR U44
Water Side	Operation Range (leaving water temperature)	Heating	Min. - Max.	°C DB	15 - 65		
		Cooling			5 - 27 (16 - 27) <sup>1)</sup>		
		DHW			15 - 80 <sup>2)</sup>		
	Piping Connections	Water Circuit	Inlet	Inch	Male PT 1" according to ISO 7-1 (tapered pipe threads)		
		Outlet	Inch	Male PT 1" according to ISO 7-1 (tapered pipe threads)			
	Rated Water Flow Rate at LWT 35°C			LPM	15.8	20.1	25.9
Refrigerant Side	Operation Range (outdoor temperature)	Heating	Min - Max	°C DB	-25 - 35		
		Cooling			5 - 48		
	Compressor	Quantity	EA	1			
		Type	-	Hermetic Sealed Scroll			
	Refrigerant	Type	-	R32			
		GWP (Global Warming Potential)	-	675			
Precharged Amount		g	1,400				
	t-CO <sub>2</sub> eq	-	0.945				
Sound Power Level		Heating	Rated Low Noise Mode	dB(A)	57		
					54		55
Sound Pressure Level (at 1m)		Heating	Rated Low Noise Mode	dB(A)	35		
					32		33
Dimensions		Unit	W x H x D	mm	1,239 x 834 x 330		
Weight		Unit		kg	89.0		
Exterior		Color / RAL Code		-	Warm Gray / RAL 7044		
Power Supply		Voltage, Phase, Frequency		V, Ø, Hz	220-240, 1, 50		
	Rated Running Current	Heating	A	5.2	6.6	8.7	
		Cooling	A	5.2	6.9	9.5	
	Recommended Circuit Breaker		A	16	20	25	
Wiring Connections		Power Supply Cable (included earth, H07RN-F)		mm <sup>2</sup> x cores	4.0 x 3C		

1) When fan coil unit not used.  
2) DHW 58-80°C Operating is available only when the booster heater is operating.

#### Note

- Due to our policy of innovation some specifications may be changed without notification.
- Wiring cable size must comply with the applicable local and national codes. Especially the power cable and circuit breaker should be selected in accordance with that.
- Sound power level is measured on the rated condition in accordance with ISO 9614 standard. Sound pressure level is converted from sound power level based on tonality penalty of 0dB and installation in free-field. Therefore, these values can be increased owing to ambient conditions during operation. Rated sound power level is according to the EN12102-1 under conditions of the EN14825.
- Performances are accordance with EN14511 and reflect ErP testing conditions. Above gives the declared values at rated conditions acc. ErP regulation.
  - Rated running current : Outdoor Temp. 7°C DB / 6°CWB, LWT 35°C
- This product contains Fluorinated greenhouse gases.

# PRODUCT SPECIFICATION

## Performance Table for Heating Operation

Maximum Heating Capacity (Including Defrost Effect)

### HM051MR U44

Outdoor Temperature	LWT 30 °C	LWT 35 °C	LWT 40 °C	LWT 45 °C	LWT 50 °C	LWT 55 °C	LWT 60 °C	LWT 65 °C
	TC	TC	TC	TC	TC	TC	TC	TC
-25°C DB	5.50	5.50	5.50	5.50	-	-	-	-
-20°C DB	5.50	5.50	5.50	5.50	5.23	-	-	-
-15°C DB	5.50	5.50	5.50	5.50	5.23	5.23	-	-
-7°C DB	5.50	5.50	5.50	5.50	5.50	5.50	5.50	-
-4°C DB	5.50	5.50	5.50	5.50	5.50	5.50	5.50	5.50
-2°C DB	5.50	5.50	5.50	5.50	5.50	5.50	5.50	5.50
2°C DB	5.50	5.50	5.50	5.50	5.50	5.50	5.50	5.50
7°C DB	5.50	5.50	5.50	5.50	5.50	5.50	5.50	5.50
10°C DB	5.50	5.50	5.50	5.50	5.50	5.50	5.50	5.50
15°C DB	5.50	5.50	5.50	5.50	5.50	5.50	5.50	5.50
18°C DB	5.50	5.50	5.50	5.50	5.50	5.50	5.50	5.50
20°C DB	5.50	5.50	5.50	5.50	5.50	5.50	5.50	5.50
35°C DB	5.50	5.50	5.50	5.50	5.50	5.50	5.50	5.50

### HM071MR U44

Outdoor Temperature	LWT 30 °C	LWT 35 °C	LWT 40 °C	LWT 45 °C	LWT 50 °C	LWT 55 °C	LWT 60 °C	LWT 65 °C
	TC	TC	TC	TC	TC	TC	TC	TC
-25°C DB	5.85	5.85	5.85	5.85	-	-	-	-
-20°C DB	6.43	6.43	6.43	6.43	6.10	-	-	-
-15°C DB	7.00	7.00	7.00	7.00	6.65	6.65	-	-
-7°C DB	7.00	7.00	7.00	7.00	7.00	7.00	7.00	-
-4°C DB	7.00	7.00	7.00	7.00	7.00	7.00	7.00	7.00
-2°C DB	7.00	7.00	7.00	7.00	7.00	7.00	7.00	7.00
2°C DB	7.00	7.00	7.00	7.00	7.00	7.00	7.00	7.00
7°C DB	7.00	7.00	7.00	7.00	7.00	7.00	7.00	7.00
10°C DB	7.00	7.00	7.00	7.00	7.00	7.00	7.00	7.00
15°C DB	7.00	7.00	7.00	7.00	7.00	7.00	7.00	7.00
18°C DB	7.00	7.00	7.00	7.00	7.00	7.00	7.00	7.00
20°C DB	7.00	7.00	7.00	7.00	7.00	7.00	7.00	7.00
35°C DB	7.00	7.00	7.00	7.00	7.00	7.00	7.00	7.00

### HM091MR U44

Outdoor Temperature	LWT 30 °C	LWT 35 °C	LWT 40 °C	LWT 45 °C	LWT 50 °C	LWT 55 °C	LWT 60 °C	LWT 65 °C
	TC	TC	TC	TC	TC	TC	TC	TC
-25°C DB	6.20	6.20	6.20	6.20	-	-	-	-
-20°C DB	7.60	7.60	7.60	7.60	7.22	-	-	-
-15°C DB	9.00	9.00	9.00	9.00	8.55	8.55	-	-
-7°C DB	9.00	9.00	9.00	9.00	9.00	9.00	9.00	-
-4°C DB	9.00	9.00	9.00	9.00	9.00	9.00	9.00	9.00
-2°C DB	9.00	9.00	9.00	9.00	9.00	9.00	9.00	9.00
2°C DB	9.00	9.00	9.00	9.00	9.00	9.00	9.00	9.00
7°C DB	9.00	9.00	9.00	9.00	9.00	9.00	9.00	9.00
10°C DB	9.00	9.00	9.00	9.00	9.00	9.00	9.00	9.00
15°C DB	9.00	9.00	9.00	9.00	9.00	9.00	9.00	9.00
18°C DB	9.00	9.00	9.00	9.00	9.00	9.00	9.00	9.00
20°C DB	9.00	9.00	9.00	9.00	9.00	9.00	9.00	9.00
35°C DB	9.00	9.00	9.00	9.00	9.00	9.00	9.00	9.00

Note

1. DB : Dry Bulb Temperature (°C), LWT : Leaving Water Temperature (°C), LPM : Liters Per Minute (ℓ/min), TC : Total Capacity (kW)
2. Direct interpolation is permissible. Do not extrapolate.
3. Measuring procedure follows EN-14511.
  - Rated values are based on standard conditions and it can be found on specifications.
  - Above table values may not be matched according to installation condition. Except for rated value, the performance is not guaranteed.
  - In accordance with the test standard (or nations), the rating will vary slightly.
4. The shaded areas are not guaranteed continuous operation.

## Performance Table for Cooling Operation

Maximum Cooling Capacity

### HM051MR U44

Outdoor Temperature	LWT 7°C	LWT 10°C	LWT 13°C	LWT 15°C	LWT 18°C	LWT 20°C	LWT 22°C
	TC	TC	TC	TC	TC	TC	TC
10°C DB	5.50	5.50	5.50	5.50	5.50	5.50	5.50
20°C DB	5.50	5.50	5.50	5.50	5.50	5.50	5.50
30°C DB	5.50	5.50	5.50	5.50	5.50	5.50	5.50
35°C DB	5.50	5.50	5.50	5.50	5.50	5.50	5.50
40°C DB	5.29	5.32	5.36	5.38	5.41	5.43	5.45
45°C DB	5.09	5.15	5.21	5.25	5.31	5.36	5.40

### HM071MR U44

Outdoor Temperature	LWT 7°C	LWT 10°C	LWT 13°C	LWT 15°C	LWT 18°C	LWT 20°C	LWT 22°C
	TC	TC	TC	TC	TC	TC	TC
10°C DB	7.00	7.00	7.00	7.00	7.00	7.00	7.00
20°C DB	7.00	7.00	7.00	7.00	7.00	7.00	7.00
30°C DB	7.00	7.00	7.00	7.00	7.00	7.00	7.00
35°C DB	7.00	7.00	7.00	7.00	7.00	7.00	7.00
40°C DB	6.36	6.45	6.55	6.61	6.71	6.77	6.84
45°C DB	5.71	5.82	5.92	5.99	6.10	6.17	6.24

### HM091MR U44

Outdoor Temperature	LWT 7°C	LWT 10°C	LWT 13°C	LWT 15°C	LWT 18°C	LWT 20°C	LWT 22°C
	TC	TC	TC	TC	TC	TC	TC
10°C DB	9.00	9.00	9.00	9.00	9.00	9.00	9.00
20°C DB	9.00	9.00	9.00	9.00	9.00	9.00	9.00
30°C DB	9.00	9.00	9.00	9.00	9.00	9.00	9.00
35°C DB	9.00	9.00	9.00	9.00	9.00	9.00	9.00
40°C DB	7.66	7.66	7.65	7.65	7.65	7.65	7.65
45°C DB	6.31	6.35	6.39	6.42	6.45	6.48	6.51

Note

1. DB : Dry Bulb Temperature (°C), LWT : Leaving Water Temperature (°C), LPM : Liters Per Minute (ℓ/min), TC : Total Capacity (kW)
2. Direct interpolation is permissible. Do not extrapolate.
3. Measuring procedure follows EN-14511.
  - Rated values are based on standard conditions and it can be found on specifications.
  - Above table values may not be matched according to installation condition. Except for rated value, the performance is not guaranteed.
  - In accordance with the test standard (or nations), the rating will vary slightly.
4. The shaded areas are not guaranteed continuous operation.

# PRODUCT SPECIFICATION

## Drawings

Category	Unit	Model Name		
		Capacity (kW)		
		5.5	7.0	9.0
1 Phase Model 220 - 240V, 1Ø, 50Hz	Monobloc Unit	HM051MR U44	HM071MR U44	HM091MR U44

HM051MR U44 / HM071MR U44 / HM091MR U44

[Unit : mm]

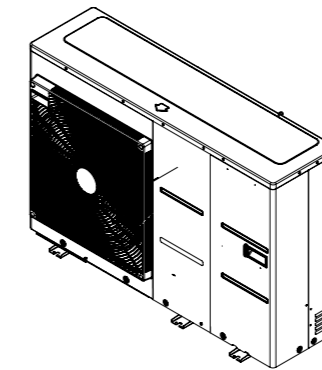
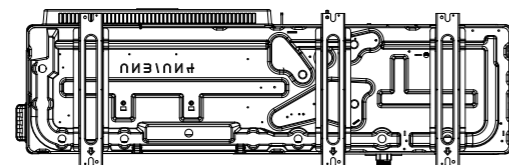
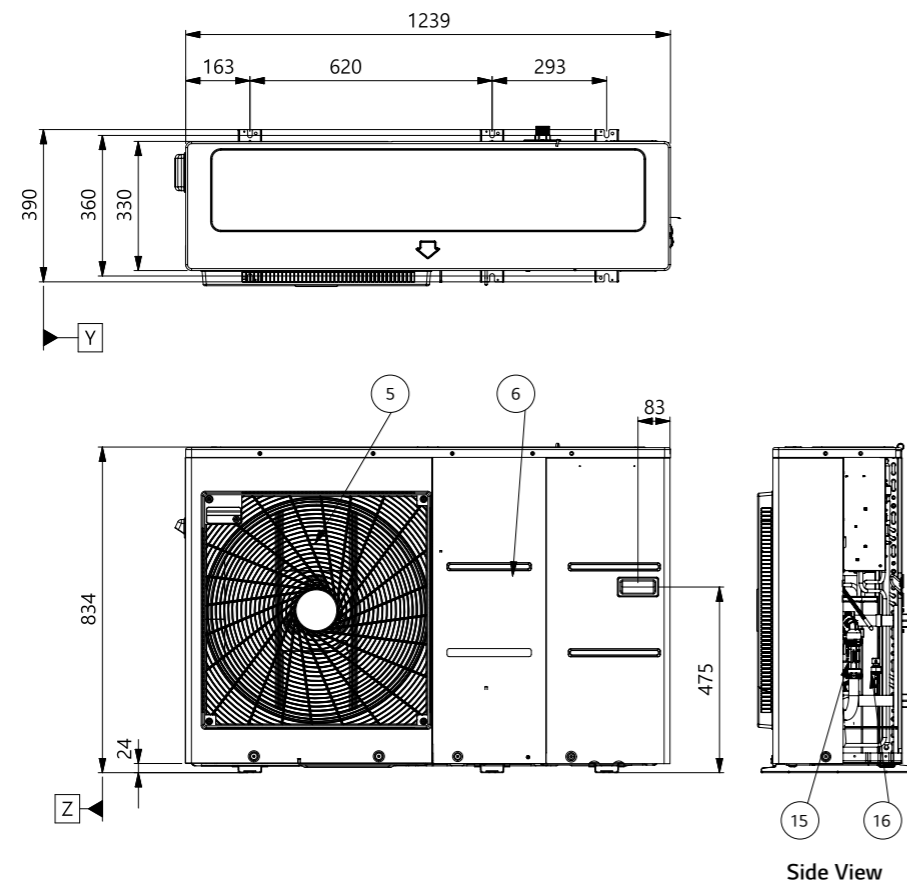

3D View

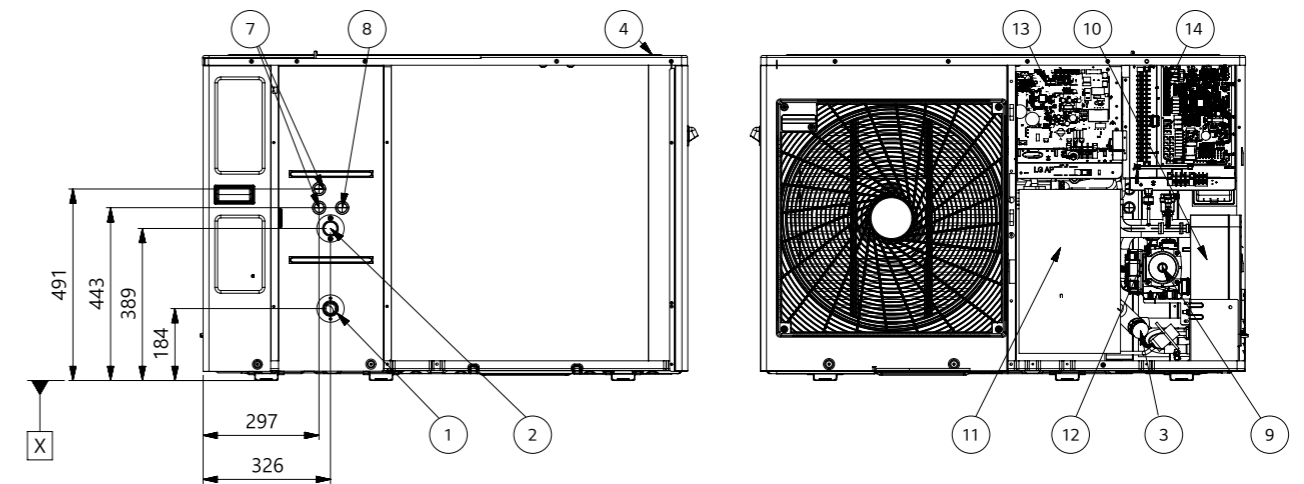

No.	Part Name	Description
1	Entering water pipe	Male PT 1" according to ISO 7-1 (tapered pipe threads)
2	Leaving water pipe	Male PT 1" according to ISO 7-1 (tapered pipe threads)
3	Strainer	Filtering and stacking particles inside circulating water
4	Top cover	-
5	Front Panel	-
6	Side Panel	-
7	Low Voltage	Communication cable hole
8	UNIT Power	Power cable hole
9	Water Pump	GRUNDFOS UPM3K 20-75 CHBL
10	Plate Heat Exchanger	Heat exchange between refrigerant and water
11	Compressor shield panel	-
12	Safety valve	Open at water pressure 3 bar
13	Indoor Control Box	Indoor PCB and terminal blocks
14	Outdoor Control Box	Outdoor PCB and terminal blocks
15	Flow sensor	SIKA VVX20 5-80 LPM
16	Pressure Sensor	SENSATA 2HMP3-05W 0-2MPa

# PRODUCT SPECIFICATION

## R32 Monobloc S



- HM121MR U34
- HM141MR U34
- HM161MR U34
- HM123MR U34
- HM143MR U34
- HM163MR U34



### Features

- All-in-one outdoor unit
- SCOP up to 4.67 (Average climate / Low temp. application) : A+++  
SCOP up to 3.47 (Average climate / Mid temp. application) : A++
- COP up to 4.90 (Outdoor air 7°C / Leaving water 35°C)
- 100% heating capacity at -15°C OAT (@ LWT 35°C, except for 16kW model)
- Low sound level allowing high installation location flexibility
- Wide operation range (ambient : -25 ~ 35°C / water side : 15 ~ 65°C)
- Built-in water flow & pressure sensors to monitor real-time water circuit
- R32 refrigerant with reduced global warming potential (GWP)
- R1 compressor
- Improved heat exchanger design (New Black Fin)
- LG ThinQ
- KEYMARK / EHPA (for Germany, 3Ø model only) / MCS / EUROVENT certification

\* EHPA (for Austria and Switzerland) label under development

### Model Line-up

Capacity	Unit	Model Name		
		Capacity (kW)		
		12.0	14.0	16.0
1 Phase Model 220 - 240V, 1Ø, 50Hz	Monobloc Unit	HM121MR U34	HM141MR U34	HM161MR U34
		HM123MR U34	HM143MR U34	HM163MR U34

### Seasonal Energy

Description	Unit	HM121MR U34 (1Ø)	HM141MR U34 (1Ø)	HM161MR U34 (1Ø)		
		HM123MR U34 (3Ø)	HM143MR U34 (3Ø)	HM163MR U34 (3Ø)		
Space Heating (According to EN14825)	Average Climate Water Outlet 35°C	SCOP	-	4.67	4.62	4.53
		Seasonal Space Heating Efficiency (η <sub>s</sub> )	%	184	182	178
		Seasonal Space Heating Eff. Class (A+++ to D Scale)	-	A+++	A+++	A+++
	Average Climate Water Outlet 55°C	SCOP	-	3.47	3.46	3.45
		Seasonal Space Heating Efficiency (η <sub>s</sub> )	%	136	135	135
		Seasonal Space Heating Eff. Class (A+++ to D Scale)	-	A++	A++	A++

### Nominal Capacity and Nominal Power Input

Description	OAT <sup>1)</sup> (DB)	LWT <sup>2)</sup> (DB)	Unit	HM121MR U34 (1Ø)	HM141MR U34 (1Ø)	HM161MR U34 (1Ø)
				HM123MR U34 (3Ø)	HM143MR U34 (3Ø)	HM163MR U34 (3Ø)
Nominal Capacity	Heating	7°C	35°C	12.00	14.00	16.00
		7°C	55°C	11.00	11.50	12.00
	Cooling	2°C	35°C	11.00	12.00	13.80
		35°C	18°C	12.00	14.00	16.00
Nominal Power Input	Heating	7°C	35°C	2.45	2.92	3.40
		7°C	55°C	3.79	4.04	4.29
	Cooling	2°C	35°C	3.01	3.31	3.83
		35°C	18°C	2.53	3.26	4.00
COP	Heating	7°C	35°C	4.90	4.80	4.70
		7°C	55°C	2.90	2.85	2.80
	Cooling	2°C	35°C	3.65	3.63	3.60
		35°C	18°C	4.75	4.30	4.00
EER				3.30	3.30	3.10

1) OAT : Outdoor Air Temperature  
2) LWT : Leaving Water Temperature

### Product Specification

Technical Specification			Unit	HM121MR U34	HM141MR U34	HM161MR U34	HM123MR U34	HM143MR U34	HM163MR U34
Water Side	Operation Range (leaving water temperature)	Heating	Min. - Max.	°C DB	15 ~ 65				
		Cooling			5 ~ 27 (16 ~ 27) <sup>1)</sup>				
	Piping Connections	Water	Inlet	Inch	Male PT 1" according to ISO 7-1 (tapered pipe threads)				
		Circuit			Outlet	Inch	Male PT 1" according to ISO 7-1 (tapered pipe threads)		
Rated Water Flow Rate at LWT 35°C			LPM	34.5	40.3		46.0	34.5	40.3
Refrigerant Side	Operation Range (outdoor temp.)	Heating	Min. - Max.	°C DB	-25 ~ 35				
		Cooling			5 ~ 48				
	Compressor	Quantity	EA	1					
		Type	-	Hermetic Sealed Scroll					
	Refrigerant	Type	-	R32					
		GWP (global warming potential)	-	675					
Precharged Amount		g	2,000						
t-CO <sub>2</sub> eq			-	1,350					
Sound Power Level	Heating	Rated	dB(A)	60	61	60	61		
		Low Noise Mode		56	57	56	57		
Sound Pressure Level (at 1m)	Heating	Rated	dB(A)	38	39	38	39		
		Low Noise Mode		34	35	34	35		
Dimensions	Unit	W x H x D	mm	1,239 x 1,380 x 330					
Weight	Unit		kg	118.6					
Exterior	Color / RAL Code		-	Warm Gray / RAL 7044					
Power Supply	Voltage, Phase, Frequency		V, Ø, Hz	220-240, 1, 50			380-415, 3, 50		
	Rated Running Current	Heating	A	10.9	12.9	15.1	3.6	4.3	5.0
		Cooling	A	11.2	14.4	17.7	3.7	4.8	5.9
Recommended Circuit Breaker		A		40			16		
Wiring Connections		Power Supply Cable (included earth, H07RN-F)	mm <sup>2</sup> x cores	6.0 x 3C			4.0 x 5C		

1) When fan coil unit not used.  
2) DHW 58-80°C Operating is available only when the booster heater is operating.

#### Note

1. Due to our policy of innovation some specifications may be changed without notification.
2. Wiring cable size must comply with the applicable local and national codes. Especially the power cable and circuit breaker should be selected in accordance with that.
3. Sound power level is measured on the rated condition in according with ISO 9614 standard. Sound pressure level is converted from sound power level based on tonality penalty of 0dB and installation in free-field. Therefore, these values can be increased owing to ambient conditions during operation. Rated sound power level is according to the EN12102-1 under conditions of the EN14825.
4. Performances are accordance with EN14511 and reflect ErP testing conditions. Above gives the declared values at rated conditions acc. ErP regulation.
  - Rated running current : Outdoor Temp. 7°C DB / 6°C CWB, LWT 35°C
5. This product contains Fluorinated greenhouse gases.

# PRODUCT SPECIFICATION

## Performance Table for Heating Operation

Maximum Heating Capacity (Including Defrost Effect)

### HM121MR U34 / HM123MR U34

Outdoor Temperature	LWT 30 °C	LWT 35 °C	LWT 40 °C	LWT 45 °C	LWT 50 °C	LWT 55 °C	LWT 60 °C	LWT 65 °C
	TC	TC	TC	TC	TC	TC	TC	TC
-25°C DB	9.50	9.50	9.50	9.50	-	-	-	-
-20°C DB	10.75	10.75	10.75	10.75	10.21	-	-	-
-15°C DB	12.00	12.00	12.00	12.00	11.50	11.50	-	-
-7°C DB	12.00	12.00	12.00	12.00	12.00	12.00	12.00	-
-4°C DB	12.00	12.00	12.00	12.00	12.00	12.00	12.00	12.00
-2°C DB	12.00	12.00	12.00	12.00	12.00	12.00	12.00	12.00
2°C DB	12.00	12.00	12.00	12.00	12.00	12.00	12.00	12.00
7°C DB	12.00	12.00	12.00	12.00	12.00	12.00	12.00	12.00
10°C DB	12.00	12.00	12.00	12.00	12.00	12.00	12.00	12.00
15°C DB	12.00	12.00	12.00	12.00	12.00	12.00	12.00	12.00
18°C DB	12.00	12.00	12.00	12.00	12.00	12.00	12.00	12.00
20°C DB	12.00	12.00	12.00	12.00	12.00	12.00	12.00	12.00
35°C DB	12.00	12.00	12.00	12.00	12.00	12.00	12.00	12.00

### HM141MR U34 / HM143MR U34

Outdoor Temperature	LWT 30 °C	LWT 35 °C	LWT 40 °C	LWT 45 °C	LWT 50 °C	LWT 55 °C	LWT 60 °C	LWT 65 °C
	TC	TC	TC	TC	TC	TC	TC	TC
-25°C DB	10.00	10.00	10.00	10.00	-	-	-	-
-20°C DB	12.00	12.00	12.00	12.00	11.40	-	-	-
-15°C DB	14.00	14.00	14.00	14.00	13.30	13.30	-	-
-7°C DB	14.00	14.00	14.00	14.00	14.00	14.00	14.00	-
-4°C DB	14.00	14.00	14.00	14.00	14.00	14.00	14.00	14.00
-2°C DB	14.00	14.00	14.00	14.00	14.00	14.00	14.00	14.00
2°C DB	14.00	14.00	14.00	14.00	14.00	14.00	14.00	14.00
7°C DB	14.00	14.00	14.00	14.00	14.00	14.00	14.00	14.00
10°C DB	14.00	14.00	14.00	14.00	14.00	14.00	14.00	14.00
15°C DB	14.00	14.00	14.00	14.00	14.00	14.00	14.00	14.00
18°C DB	14.00	14.00	14.00	14.00	14.00	14.00	14.00	14.00
20°C DB	14.00	14.00	14.00	14.00	14.00	14.00	14.00	14.00
35°C DB	14.00	14.00	14.00	14.00	14.00	14.00	14.00	14.00

### HM161MR U34 / HM163MR U34

Outdoor Temperature	LWT 30 °C	LWT 35 °C	LWT 40 °C	LWT 45 °C	LWT 50 °C	LWT 55 °C	LWT 60 °C	LWT 65 °C
	TC	TC	TC	TC	TC	TC	TC	TC
-25°C DB	10.50	10.50	10.50	10.50	-	-	-	-
-20°C DB	13.25	13.25	13.25	13.25	12.59	-	-	-
-15°C DB	16.00	14.40	14.40	14.40	13.68	13.68	-	-
-7°C DB	16.00	16.00	16.00	16.00	16.00	16.00	16.00	-
-4°C DB	16.00	16.00	16.00	16.00	16.00	16.00	16.00	16.00
-2°C DB	16.00	16.00	16.00	16.00	16.00	16.00	16.00	16.00
2°C DB	16.00	16.00	16.00	16.00	16.00	16.00	16.00	16.00
7°C DB	16.00	16.00	16.00	16.00	16.00	16.00	16.00	16.00
10°C DB	16.00	16.00	16.00	16.00	16.00	16.00	16.00	16.00
15°C DB	16.00	16.00	16.00	16.00	16.00	16.00	16.00	16.00
18°C DB	16.00	16.00	16.00	16.00	16.00	16.00	16.00	16.00
20°C DB	16.00	16.00	16.00	16.00	16.00	16.00	16.00	16.00
35°C DB	16.00	16.00	16.00	16.00	16.00	16.00	16.00	16.00

Note

- DB : Dry Bulb Temperature (°C), LWT : Leaving Water Temperature (°C), LPM : Liters Per Minute (ℓ/min), TC : Total Capacity (kW)
- Direct interpolation is permissible. Do not extrapolate.
- Measuring procedure follows EN-14511.
  - Rated values are based on standard conditions and it can be found on specifications.
  - Above table values may not be matched according to installation condition. Except for rated value, the performance is not guaranteed.
  - In accordance with the test standard (or nations), the rating will vary slightly.
- The shaded areas are not guaranteed continuous operation.

## Performance Table for Cooling Operation

Maximum Cooling Capacity

### HM121MR U34 / HM123MR U34

Outdoor Temperature	LWT 7°C	LWT 10°C	LWT 13°C	LWT 15°C	LWT 18°C	LWT 20°C	LWT 22°C
	TC	TC	TC	TC	TC	TC	TC
10°C DB	12.00	12.00	12.00	12.00	12.00	12.00	12.00
20°C DB	12.00	12.00	12.00	12.00	12.00	12.00	12.00
30°C DB	12.00	12.00	12.00	12.00	12.00	12.00	12.00
35°C DB	12.00	12.00	12.00	12.00	12.00	12.00	12.00
40°C DB	11.05	11.19	11.33	11.43	11.57	11.67	11.76
45°C DB	10.10	10.37	10.64	10.83	11.10	11.28	11.46

### HM141MR U34 / HM143MR U34

Outdoor Temperature	LWT 7°C	LWT 10°C	LWT 13°C	LWT 15°C	LWT 18°C	LWT 20°C	LWT 22°C
	TC	TC	TC	TC	TC	TC	TC
10°C DB	12.50	12.80	13.10	13.30	13.60	13.80	14.00
20°C DB	14.00	14.00	14.00	14.00	14.00	14.00	14.00
30°C DB	14.00	14.00	14.00	14.00	14.00	14.00	14.00
35°C DB	14.00	14.00	14.00	14.00	14.00	14.00	14.00
40°C DB	12.35	12.60	12.84	13.01	13.26	13.42	13.59
45°C DB	10.69	11.19	11.69	12.02	12.51	12.84	13.17

### HM161MR U34 / HM163MR U34

Outdoor Temperature	LWT 7°C	LWT 10°C	LWT 13°C	LWT 15°C	LWT 18°C	LWT 20°C	LWT 22°C
	TC	TC	TC	TC	TC	TC	TC
10°C DB	13.00	13.60	14.20	14.60	15.20	15.60	16.00
20°C DB	16.00	16.00	16.00	16.00	16.00	16.00	16.00
30°C DB	16.00	16.00	16.00	16.00	16.00	16.00	16.00
35°C DB	16.00	16.00	16.00	16.00	16.00	16.00	16.00
40°C DB	13.60	13.96	14.32	14.56	14.92	15.16	15.40
45°C DB	11.20	11.76	12.32	12.69	13.25	13.62	14.00

Note

- DB : Dry Bulb Temperature (°C), LWT : Leaving Water Temperature (°C), LPM : Liters Per Minute (ℓ/min), TC : Total Capacity (kW)
- Direct interpolation is permissible. Do not extrapolate.
- Measuring procedure follows EN-14511.
  - Rated values are based on standard conditions and it can be found on specifications.
  - Above table values may not be matched according to installation condition. Except for rated value, the performance is not guaranteed.
  - In accordance with the test standard (or nations), the rating will vary slightly.
- The shaded areas are not guaranteed continuous operation.

# PRODUCT SPECIFICATION

## Drawings

Category	Unit	Model Name		
		Capacity (kW)		
		12.0	14.0	16.0
1 Phase Model 220 - 240V, 1Ø, 50Hz	Monobloc Unit	HM121MR U34	HM141MR U34	HM161MR U34
3 Phase Model 380 - 415V, 3Ø, 50Hz		HM123MR U34	HM143MR U34	HM163MR U34

HM121MR U34 / HM141MR U34 / HM161MR U34 [Unit : mm]  
 HM123MR U34 / HM143MR U34 / HM163MR U34

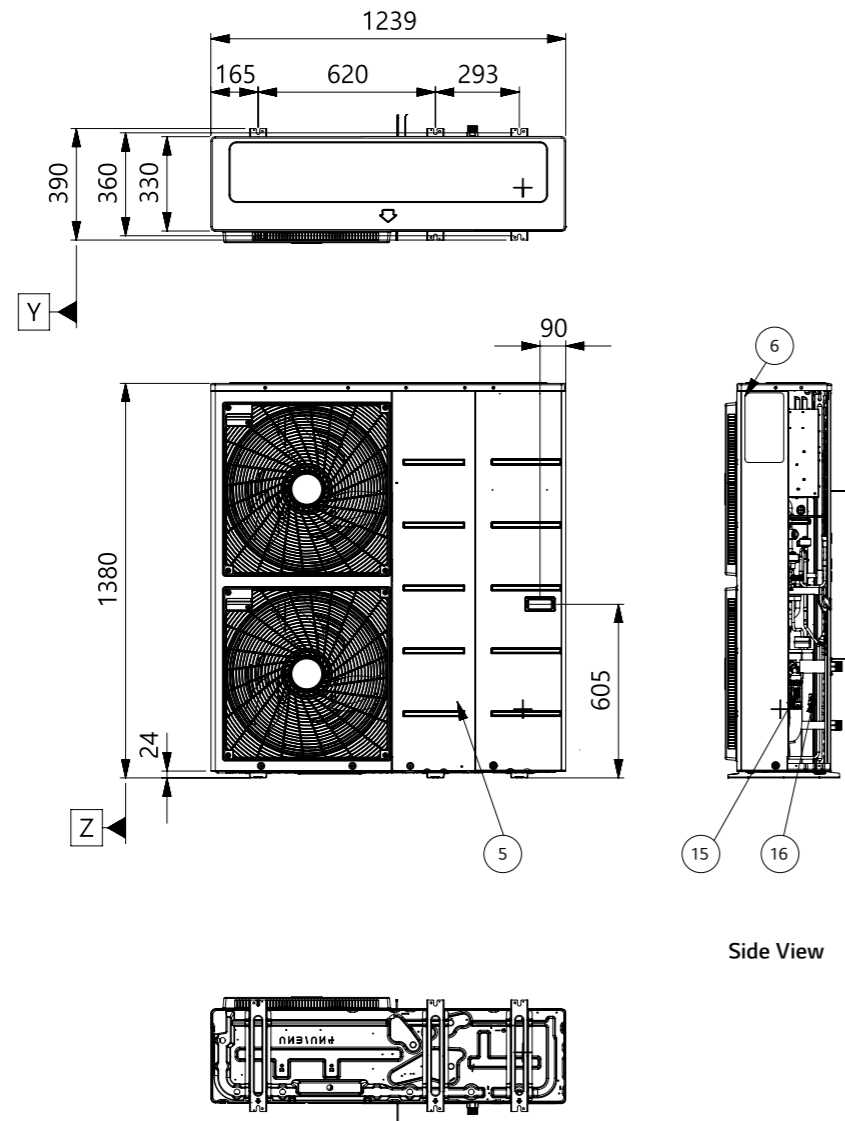

Side View

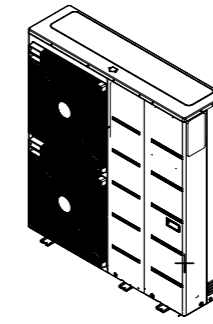

3D View

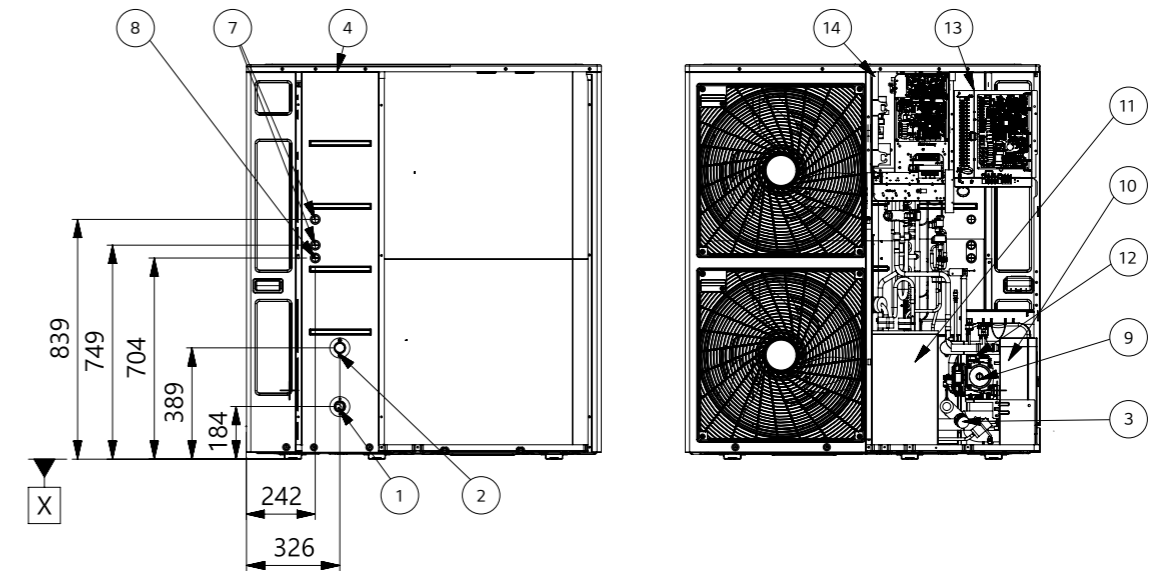

No.	Part Name	Description
1	Entering water pipe	Male PT 1" according to ISO 7-1 (tapered pipe threads)
2	Leaving water pipe	Male PT 1" according to ISO 7-1 (tapered pipe threads)
3	Strainer	Filtering and stacking particles inside circulating water
4	Top cover	-
5	Front Panel	-
6	Side Panel	-
7	Low Voltage	Communication cable hole
8	UNIT Power	Power cable hole
9	Water Pump	GRUNDFOS UPML 20-105 CHBL
10	Plate Heat Exchanger	Heat exchange between refrigerant and water
11	Compressor shield panel	-
12	Safety valve	Open at water pressure 3 bar
13	Indoor Control Box	Indoor PCB and terminal blocks
14	Outdoor Control Box	Outdoor PCB and terminal blocks
15	Flow sensor	SIKA VVX20 5-80 LPM
16	Pressure Sensor	SENSATA 2HMP3-05W 0-2MPa

# PRODUCT SPECIFICATION

## Electric Backup Heater

HA031M E1  
HA061M E1  
HA063M E1

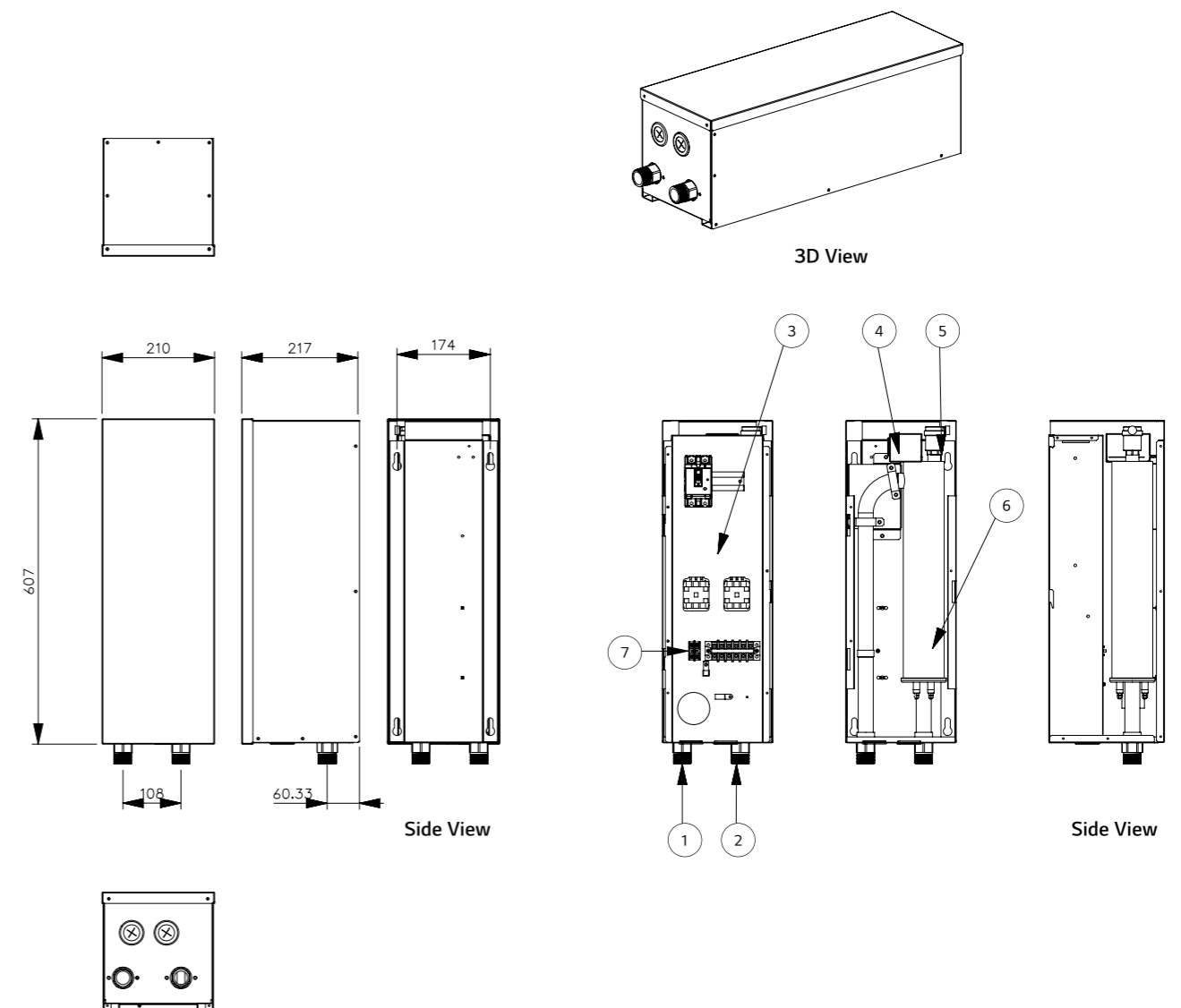

## Backup Heater Specification

Electrical Specification		Unit	HA031M E1	HA061M E1	HA063M E1
Backup Heater	Type	-	Sheath		
	Number of Heating Coil	EA	1	2	3
	Capacity Combination	kW	3.0	3.0 + 3.0	2.0 + 2.0 + 2.0
	Heating Steps	Step	1	2	1
	Power Supply	V, Ø, Hz	220 - 240, 1, 50		380 - 415, 3, 50
	Rated Running Current	A	12.5	25.0	8.7
	Recommended Circuit Breaker	A	25	40	25
	Dimensions (W x H x D)	mm	210 x 607 x 217		
	Net Weight (unit)	kg	13.0	13.8	14.1
Wiring Connections	Power Supply Cable (included earth, H07RN-F)	mm <sup>2</sup> x cores	1.5 x 3C	4.0 x 3C	2.5 x 4C
	Communication Cable (H07RN-F)	mm <sup>2</sup> x cores	0.75 x 4C		0.75 x 2C

Note  
1. Due to our policy of innovation some specifications may be changed without notification.  
2. Wiring cable size must comply with the applicable local and national codes.  
Especially the power cable and circuit breaker should be selected in accordance with that.

No.	Part Name	Description
1	Leaving Water Pipe	Male PT 1" according to ISO 7-1 (tapered pipe threads)
2	Entering Water Pipe	Male PT 1" according to ISO 7-1 (tapered pipe threads)
3	Control Box	Circuit breaker, Magnetic switch, Terminal blocks
4	Thermal switch	Cut-off power input to E/heater at 90°C
5	Air vent	Air purging when charging water
6	Electric Heater	Refer the related information
7	Backup heater outlet sensor(SI3)	Connect to unit (heat pump)













**THERMA V™**  
**ACCESSORIES**



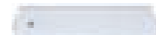

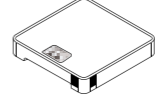
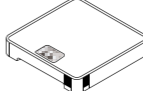

## Accessories Provided by LG

Category	Model Name	Model Number	Figure	Applicable Product	Relevant Function	Purpose	Feature
Sensors	Room Temperature Sensor	PQRSTA0		All Therma V products	Room Temperature Based Control	To detect room air temperature for room temperature based control	• Max. wire length : 15m
	Thermistor for 2 <sup>nd</sup> Circuit or E/Heater	PRSTAT5K10		All except for High Temperature	2 <sup>nd</sup> Circuit (mixing circuit)	To detect 2 <sup>nd</sup> circuit temperature when using 2 <sup>nd</sup> circuit function	• 5kΩ thermistor, 10m
	Domestic Hot Water Sensor	PHRSTA0		All except for R32 Split IWT and R32 Hydrosplit IWT	Domestic Hot Water Heating	To detect DHW tank temperature	• Included in PHLTA kit
Valves	3 Way Valve	OSHA-3V		All except for R32 Split IWT and R32 Hydrosplit IWT	Domestic Hot Water Heating	To divert water flow between space heating and DHW heating	• Size : DN 20 G 1" connection, male threaded
	Thermostatic Mixing Valve	OSHA-MV OSHA-MV1		Regardless of model	Domestic Hot Water Supply	To blend hot water with cold water for ensuring constant, safe shower and bath outlet temp.	• Size : 3/4" DN20 male threaded • Size : 1" DN25 male threaded
DHW Tanks	Domestic Hot Water Tank (single coil)	OSHW-200F OSHW-300F OSHW-500F		All except for R32 Split IWT and R32 Hydrosplit IWT	Domestic Hot Water Heating	To generate and store domestic hot water	• Storage volume : 200L, 300L, 500L • Type : Internal double coil • Material : Stainless steel • Capacity of booster heater : 2.4kW
	Domestic Hot Water Tank (double coil)	OSHW-300FD		All except for R32 Split IWT, R32 Hydrosplit IWT and High Temperature			• Storage volume : 300L • Type : Internal double coil • Material : Stainless steel • Capacity of booster heater : 2.4kW
Installation Kits	Domestic Hot Water Tank Kit	PHLTA		R32 Split Hydro Box, R410A Split Hydro Box, R32 Hydrosplit Hydro Box	Domestic Hot Water Heating	To operate with DHW tank	• Parts included : DHW tank sensor (thermistor), Circuit breaker, Relay
		PHLTC		R410A Split Hydro Box (HN1639 NK3, 3Ø only)			• Parts included : DHW tank sensor (thermistor), Circuit breaker, Relay, Multi harness
		PHLTB	R32 Monobloc, R32 Monobloc S				
	Solar Thermal Kit	PHLLA		R32 Monobloc, R410A Split Hydro Box (HN1639 NK3, 3Ø only)	Solar Thermal Heat Utilization	To operate with solar thermal system	• Length of thermistor : 12m • Size of tube connector (W x H x D) : 110 x 55 x 22

Category	Model Name	Model Number	Figure	Applicable Product	Relevant Function	Purpose	Feature
Installation Kits	Electric Back Up Heater	HA031M E1		R32 Monobloc, R32 Monobloc S	Capacity Back Up & Emergency Operation	To supplement insufficient capacity	• Heater capacity : 3kW • Number of heating coil : 1EA (3.0kW) • Size (W x H x D) : 210 x 607 x 217 • Power : 220 - 240V, 1Ø
		HA061M E1					• Heater capacity : 6kW • Number of heating coil : 2EA (3.0 + 3.0kW) • Size (W x H x D) : 210 x 607 x 217 • Power : 220 - 240V, 1Ø
		HA063M E1					• Heater capacity : 6kW • Number of heating coil : 3EA (2.0 + 2.0 + 2.0kW) • Size (W x H x D) : 210 x 607 x 217 • Power : 380 - 415V, 3Ø
	R32 Hydrosplit Hydro Box (HN1600MC NK1)	HA061C E1		R32 Hydrosplit Hydro Box (HN1600MC NK1)	Capacity Back Up & Emergency Operation	To supplement insufficient capacity	• Heater capacity : 6 kW • Number of heating coil : 2EA (3.0 + 3.0kW) • Power : 220-240 V, 1Ø
		HA063C E1					• Heater capacity : 6 kW • Number of heating coil : 3EA (2.0 + 2.0 + 2.0kW) • Power : 220-240 V, 3Ø
	Vessel	Buffer Tank for Space Heating	OSHB-40KT		R32 Split IWT and R32 Hydrosplit IWT	-	To provide the buffer volume of water to the heating circuit
Expansion Vessel for DHW		OSHE-12KT		R32 Split IWT and R32 Hydrosplit IWT	-	To absorb the volume changes by temperature of water for the DHW circuit	• Volume : 8L • Connection : 3/4" • Max. pressure : 10 bar • Size (W x H x D) : 416 x 238 x 502
ETC	Extension Wire for Wire Remote Controller	PZCWRC1		All Therma V products	-	To extend wire between wired remote controller and indoor unit	• Length : 10m
	Extension Cable for Wi-Fi Modem	PWYREW000		All Therma V products	Wi-Fi Control via LG ThinQ	To extend wire between Wi-Fi modem and indoor unit	• Length : 10m
	2 Remote Control Wire	PZCWRC2		All Therma V products	2 Remote Control	To connect two remote controller on the one indoor unit	• Length : 0.25m
	Drain Pan	PHDPB		R32 Split Hydro Box (HN0916M NK4), R410A Split Hydro Box (HN1616 NK3 / HN1639 NK3)	Cooling Operation	To collect condensed water in indoor unit when cooling operation	-
		PHDPC					R32 Hydrosplit, R32 Split Hydro Box (HN091MR NK5), R410A Split Hydro Box (HN1616M NK5 / HN1636M NK5)
Cover Plate	PDC-HK10		R32 Hydrosplit Hydro Box, R32 Hydrosplit IWT, R32 Split Hydro Box, R32 Split IWT, R410A Split Hydro Box	-	To fill the blank space of the indoor unit front panel when the remote controller is relocated indoors.	-	

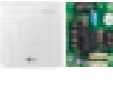
## Accessories Provided by LG

Category	Model Name	Model Number	Figure	Applicable Product	Relevant Function	Purpose	Feature
Remote Controller	Wired Remote Controller	PREMTW101		All Therma V products	2 Remote Control	To control AWHP using two remote controller (additional remote controller)	<ul style="list-style-type: none"> <li>New modern design 4.3 inch color LCD display</li> <li>Information displayed with simple graphic, icon &amp; text</li> <li>Built-in temperature sensor</li> <li>Size (W x H x D) : 120 x 120 x 16</li> <li>Extension cable (PZCWRC1, 10m) and 2 remote cable (PZCWRC2, 0.25m) are included</li> </ul>
Central Controller	AC Ez Touch	PACEZA000		All Therma V products	Centralized Control	To control AWHP using LG central controller	<ul style="list-style-type: none"> <li>5 inch color display</li> <li>User-friendly control with iconographic interface (touch screen)</li> <li>Max. 32 unit control</li> <li>Total 200 schedule events (weekly / monthly / yearly / exception day)</li> <li>Operation history</li> <li>Remote controller lock (all, temp, mode)</li> <li>PC access supported (IPv6 supported)</li> <li>DI 1EA (emergency stop only)</li> <li>Size (W x H x D) : 137 x 121 x 25</li> </ul>
	AC Smart 5	PACS4B000 (Smart 4) PACS5A000 (Smart 5)					<ul style="list-style-type: none"> <li>10.2 inch color display</li> <li>User-friendly control with iconographic interface (touch screen)</li> <li>(Smart 4)_Max. IDU 32, (Smart 5)_Max. IDU 64</li> <li>Total 100 schedule events (weekly / monthly / yearly / exception day)</li> <li>History / operation trend</li> <li>Interlock with 3<sup>rd</sup> party equipment (ACS IO, ACU IO module is needed)</li> <li>Error alarm by e-mail</li> <li>Remote controller lock (all, temp, mode)</li> <li>Map view (visual navigation)</li> <li>Web access supported with HTML5 (PC, smartphone, tablet)</li> <li>DI 2EA, DO 2EA</li> <li>BACnet IP/modbus TCP protocol support</li> <li>Size (W x H x D) : 253.2 x 167.7 x 28.9</li> </ul>
	ACP 5	PACP4B000 (ACP4) PACP5A000 (ACP5)					<ul style="list-style-type: none"> <li>Web access controller</li> <li>Max. 128 unit control</li> <li>Total 100 schedule events (weekly / monthly / yearly / exception day)</li> <li>History / operation trend</li> <li>Interlock with 3<sup>rd</sup> party equipment (ACS IO, ACU IO module is needed)</li> <li>Error alarm by e-mail</li> <li>Remote controller lock (all, temp, mode)</li> <li>Map view (visual navigation)</li> <li>DI 10EA, DO 4EA</li> <li>BACnet IP/modbus TCP protocol support</li> <li>Size (W x H x D) : 270 x 155 x 65</li> </ul>

Category	Model Name	Model Number	Figure	Applicable Product	Relevant Function	Purpose	Feature
Gateway	ACP Lonworks	PLNWKB000		All Therma V products	Centralized Control	To link with AWHP and other existing building control system	<ul style="list-style-type: none"> <li>Web access controller</li> <li>Max. 64 unit control</li> <li>ACP function included</li> <li>Lonworks protocol support</li> <li>Size (W x H x D) : 270 x 155 x 65</li> </ul>
	Modbus RTU Gateway	PMBUSB00A				To communicate and control through the central controller (providing modbus RTU connection between AWHP and BMS)	<ul style="list-style-type: none"> <li>Modbus RTU slave (RS485) / 9,600 bps</li> <li>Size (W x H x D) : 53.6 x 89.7 x 60.7</li> <li>Max. 16 IDUs with single module / Max. 64 IDUs with 4 modules</li> <li>Power : DC 12V</li> </ul>
	PI485 Gateway	PMNFP14A1				To communicate and control through the central controller (converting LG protocol to RS485 protocol)	<ul style="list-style-type: none"> <li>1 for each outdoor unit</li> <li>Power : Supplied by outdoor unit</li> </ul>
Dry Contact	Simple Dry Contact	PDRYCB000		All Therma V products	-	To connect between the AWHP and external devices to control various functions	<ul style="list-style-type: none"> <li>1 Set per 1 unit</li> <li>1 Input contact for turning on/off</li> <li>Input power : 220 - 240V</li> <li>2 output contacts</li> <li>- Operation status - Error status</li> </ul>
	Dry Contact for Thermostat	PDRYCB320					<ul style="list-style-type: none"> <li>1 Set per 1 unit</li> <li>Non voltage or 12 - 24V</li> <li>8 digital input contacts for thermostat</li> <li>- On/off operation mode, DHW heating</li> <li>- Emergency mode, silent mode</li> <li>2 Output contacts</li> <li>- Operation status - Error status</li> </ul>
ETC	LG Wi-Fi Modem	PWFMDD200		All Therma V products	Wi-Fi Control via LG ThinQ	To control AWHP via smartphone	<ul style="list-style-type: none"> <li>Basic control function</li> <li>- On/off, operation mode, set temp</li> <li>- DHW heating and set temp</li> <li>Weekly on/off schedule</li> <li>Error status check</li> <li>Frequency : 2.4GHz</li> <li>IEEE 802.11b/g/n supported</li> </ul>
	Meter Interface	PENKTH000				Energy Monitoring	To measure production / consumption power

Note  
1. PI485 Gateway (PMNFP14A1) should be installed on outdoor unit to use central controller.

# ACCESSORIES

## LG Wi-Fi Modem

PWFMDD200 ENCXLEU

Access LG THERMA V anytime and from anywhere with Wi-Fi equipped device. LG's exclusive Home Appliances control app (LG ThinQ) is available.

Simple operation for various functions.

- On/off
- Operation mode selection
- Current temperature
- Set temperature
- On/off reservation scheduling
- Energy monitoring
- ESS monitoring
- Silent mode reservation
- Holiday mode
- Quick DHW heating



<b>Model Name</b>	<b>PWFMDD200</b>
<b>Size (mm)</b>	46 x 68 x 14
<b>Interfaceable Products</b>	All THERMA V Line-ups except for R410A IWT
<b>Connection Type</b>	Indoor Unit 1 : 1
<b>Communication Frequency</b>	2.4GHz
<b>Wireless Standards</b>	IEEE 802.11b/g/n
<b>Mobile Application</b>	LG ThinQ (Android v4.1 (Jellybean) or higher, iPhone iOS 9.0 or higher)
<b>Optional Extension Cable</b>	PWYREW000 (10m extension)

Note

1. Functionality may be different according to each Indoor model.
2. User interface of application shall be revised for its design and contents improvement.
3. Application is optimized for smartphone use, so it may not be well functioning with tablet devices.
  - For the compatibility with indoor unit, please contact regional office.