

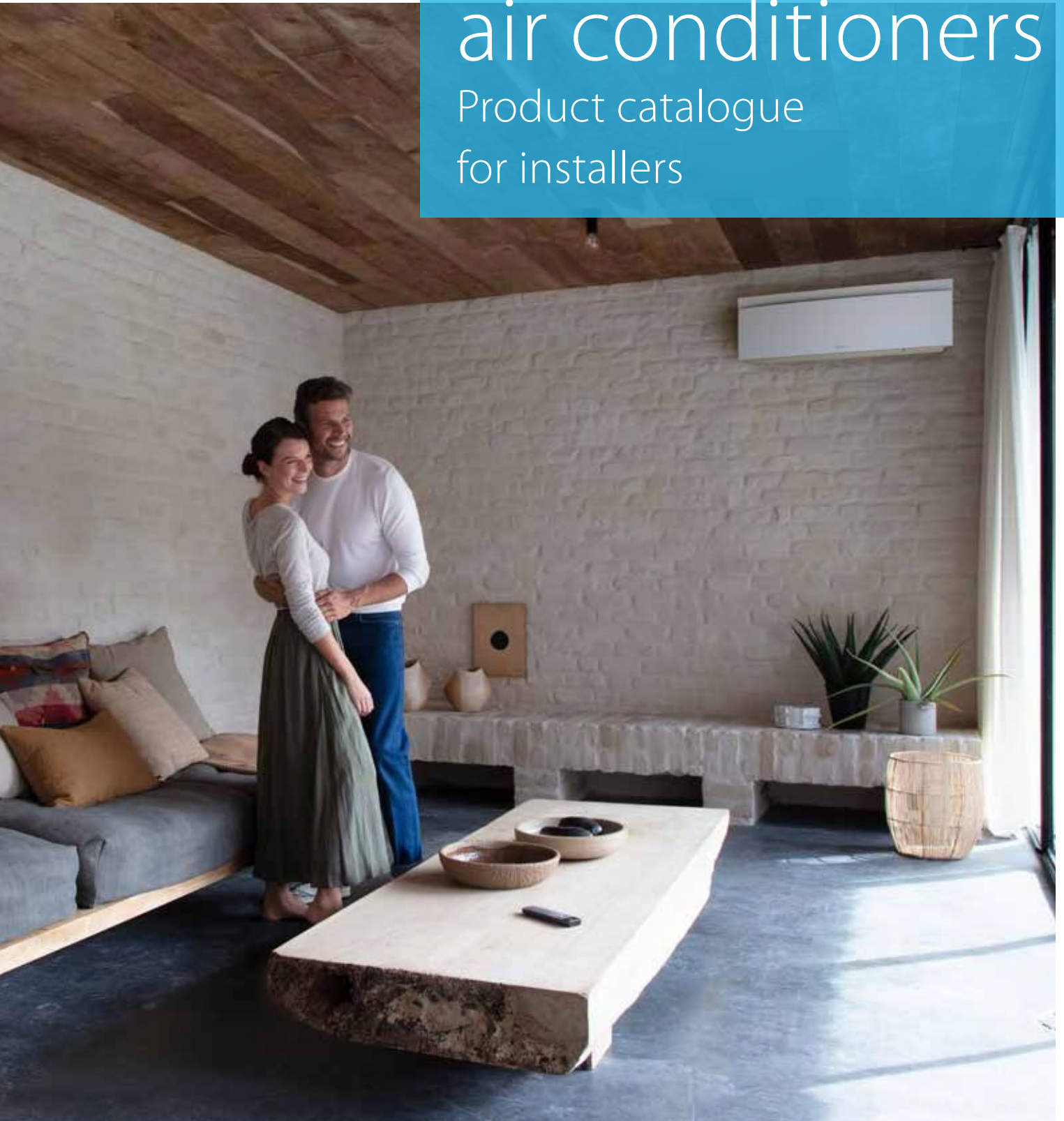

Residential air conditioners

Product catalogue
for installers





Daikin Emura



Stylish



Perfera FVXM-A





Outdoor unit

Table of contents

8 reasons to buy a Daikin (multi-)split system	4
The ultimate in comfort	5
Best performance and highest energy efficiencies	6
Top indoor air quality	8
Installer service	10
Connectivity	12
Multi	14
Quality	16
Daikin 3D app for end-users	17
Best comfort through intelligent sensors	18
Iconic and award-winning design	19
What's new in 2022	20
Ururu Sarara	22
Daikin Emura	24
Stylish	26
Perfera wall mounted unit	28
Comfora	30
Sensira	31
Perfera floor standing unit	32
Concealed ceiling FDXM-F9	34
Multi Split	36
Benefits overview	38

R-32 standard 40

Bluevolution range

UNIQUE  FTXZ-N / RXZ-N	40
 FTXJ-AW/S/B + RXJ-A	42
stylish C/FTXA-AW/BB/BT/BS + RXA-A9/B	41
perfera C/FTXM-R/RXM-R(9)	43
comfora FTXP-M (9) / RXP-M	44
UPDATE sensira FTXF-D / RXF-D	45
sensira FTXC-C / RXC-C	46
NEW sensira FTXQ-A / RXQ-A	47
perfera FVXM-A / RXM-R(9)	48
FVXM-F / RXM-R(9)	49
FDXM-F9 / RXM-R(9)	50
CHYHBH-AV32 / EHYKOMB-AA2/3	51
NEW 2MXM40-50-68A	52
NEW 3MXM40-52A	52
NEW 4MXM68-80A	52
NEW 5MXM90A	52
EKHWET-BV3 / 4MWXM-A	53

R-32 Optimised for heating 54

Bluevolution range

NEW stylish FTXTA-BW/BB / RXTA-B	56
NEW perfera FTXTM-R / RXTM-R	57
UPDATE comfora FTXTM-R / RXTM-R	58
UPDATE perfera FVXM-A / RXTM-R	59

Options & accessories 60

8 reasons to buy a Daikin (multi-)split system

Full R-32 range for average and cold outdoor temperatures

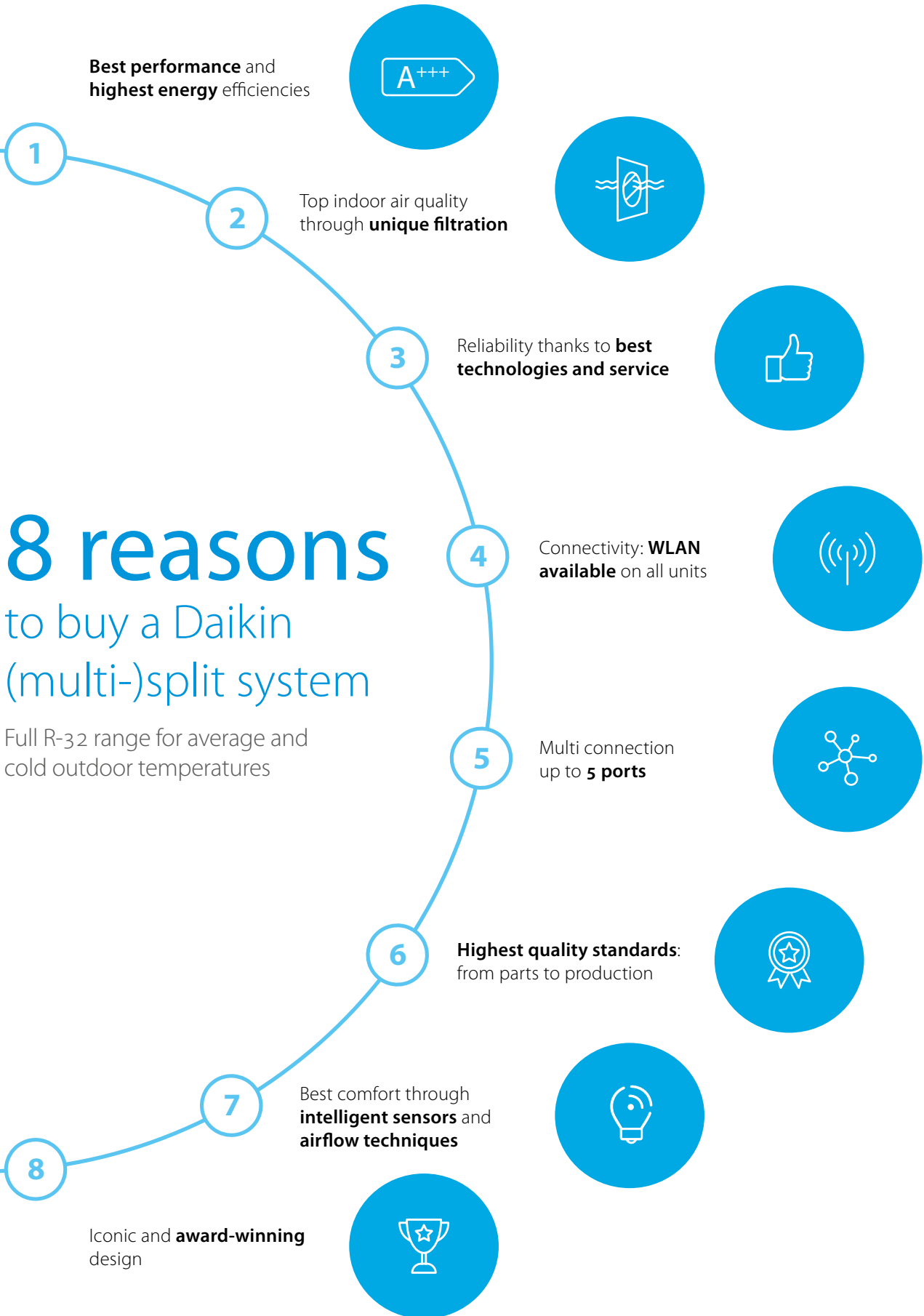

The ultimate in comfort

Designed with the highest
quality in mind

Why choose Daikin?

Our promise at Daikin is to combine the best performance with **the greatest energy efficiency** to create the most comfortable environment.

We dedicate ourselves to technological excellence that delivers **outstanding indoor air quality** through a unique filtration process.

Our reliability is second to none, thanks to the **cutting-edge technologies** used in our units and our dedication to service.

With **WLAN connectivity** available on all units, controlling your living or working environment is a breeze.

Multi-connection to 5 ports means that your comfort requirements can always be accommodated.

Build quality and operational excellence are incorporated into every Daikin unit, using the highest quality standards in the industry, from parts to the manufacturing process.

Daikin's intelligent sensors and airflow techniques are just that: smart and responsive. This delivers the highest level of comfort – it's almost as though the unit is plugged into your brain and knows exactly what you want!

Daikin takes great pride in its **iconic and award-winning designs**, which are created to provide visual beauty in addition to operating quietness and efficiency, tailored to our customers' specific needs.



Best performance

and highest energy efficiencies

An air conditioner provides you comfort all year long. Whether it is extremely cold or hot outside, you expect your air conditioner to perform in the same stable way. Our units are tested in all weather conditions, guaranteeing their capacity at all outdoor temperatures. Our special optimised for heating range provides heating even at -25°C.

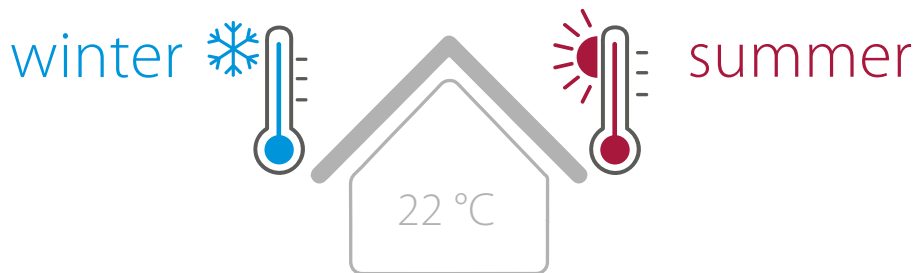

Additionally we strive for offering units with the **highest seasonal energy efficiencies, up to A+++ in cooling and heating**. This performance and efficiency level can only be met by implementing the best technologies in our units.





Heat pump principle

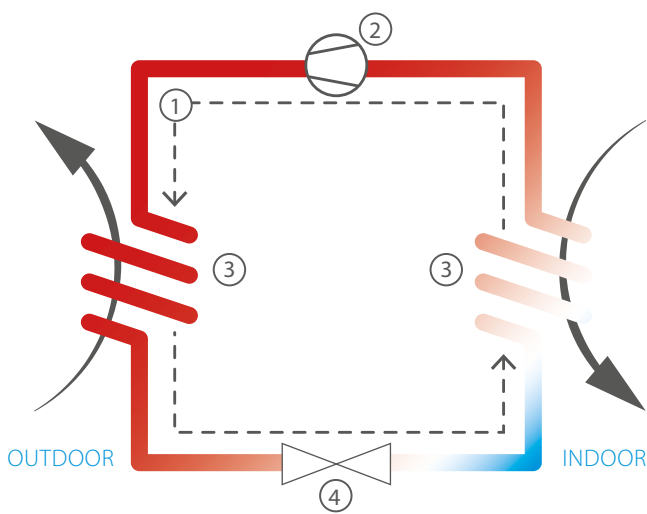

COOLING CYCLE

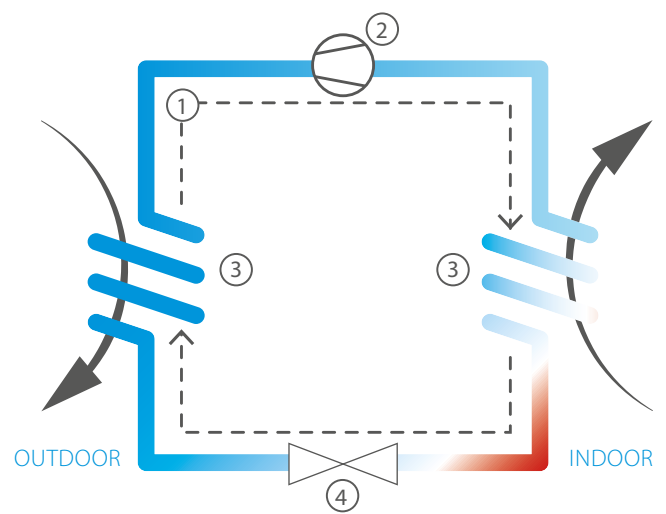

HEATING CYCLE

- ① **REFRIGERANT:** R-32 is the best energy performing refrigerant with low environmental impact, developed and produced by Daikin.
- ② **COMPRESSOR:** Our in-house developed swing compressor provides maximum capacity
- ③ **HEAT EXCHANGERS:** The evaporator and condenser are made out of high quality copper tubes, with incisions inside of the tubes to increase the exchange of heat even more.

The aluminium fins on the outdoor unit are precoated, making them resistant for harsh outdoor conditions

- ④ **THE ELECTRONIC EXPANSION VALVE** releases the liquified refrigerant electronically in the evaporator thus exact temperatures can be reached in the evaporator.

This results in:

- > Best comfort
- > Best and reliable energy efficiencies

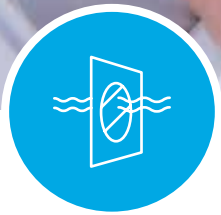





Top indoor air quality through unique filtration

Internal pollution has less obvious consequences on people and manifests the effects in the long run, this causes a lower level of attention.

90% of our time is spent indoors.
The indoor air is 2 to 5 times more polluted than outdoor air.

Within our air conditioners, we offer **several filtering techniques** depending on the range:

	Flash Streamer 	Titanium Apatite deodorising filter 	Silver Allergen removing filter 	Dust Filter 	Self Cleaning Air filter 
Ururu Sarara	•	•			•
Stylish	•	•	•	•	
Daikin Emura		•	•	•	
Perfera	•	•	•	•	
Comfora		•	•	•	
Sensira		•		•	

The **different type of filters** remove odours, allergens and dust.

		Odours 🌫️	Allergens 🌸	Dust 🌫️
Flash streamer	Using electrons to trigger chemical reactions with air borne particles, the Flash Streamer breaks down allergens such as pollen and fungal allergens and removes bothersome odours providing a better, cleaner air	•	•	
Titanium apatite deodorising filter	Decomposes bothersome odours of for example tobacco and pets	•		
Silver allergen removal and air purifying filter	Captures allergens such as pollen to ensure a steady supply of clean air		•	
Dust filter	Removes airborne dust particles to ensure a steady supply of clean air			•
Self-cleaning filter	The air filter removes airborne dust particles from the air while the integrated brush regularly and automatically cleans the filter to ensure a steady supply of clean air			•

To increase your personal comfort and indoor air quality to a next level, our air conditioners can work together with our air purifiers.

If you only require heating or cooling, an air conditioner is sufficient. If you want perfect indoor air quality including heating and/or cooling, it is advised to combine your air conditioning system with an air purifier.

Comfort



- › Cooling
- › Heating
- › Air purification by removing odours, allergens, dust



Pure air



- › Air purification by removing up to 99,7% of odours, allergens, dust, bacteria and viruses
- › Humidification

Air purifier filtering principle

CLASH

The dust collection filter catches the floating substances with the attached harmful gases and Streamer decomposes the gases by oxidation.

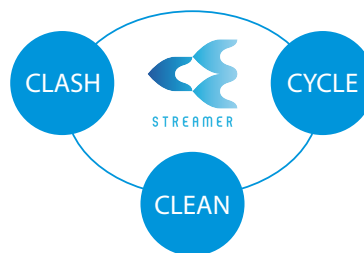

CLEAN

Removes bacteria from dust collection filter and humidifying filter.

CYCLE

The deodorising filter adsorbs and decomposes odour. Thanks to the regeneration of the adsorbing capacity, the deodorising capacity is maintained. No need to change the deodorising filter, unlike air purifiers with activated carbon filters.



*Daikin device MCK55WVM (commercial name MCK55W), tested by Institut Pasteur de Lille, removes 99.996 % of Human Coronavirus HCoV-229E in 2.5 minutes running time at 'turbo' speed in laboratory conditions (air-tight chamber with inner volume 0.47 m³, no air renewal). Human Coronavirus HCoV-229E is different from the virus responsible for COVID-19, SARS-CoV-2, but belongs to the same family of coronaviruses. Daikin device MCS55WVM (commercial names MCS55W/VB), tested by Institut Pasteur de Lille, removes 99.98 % of Human Coronavirus HCoV-229E in 2.5 minutes running time at 'turbo' speed in laboratory conditions (air-tight chamber with inner volume 1.4 m³, no air renewal). Human Coronavirus HCoV-229E is different from the virus responsible for COVID-19, SARS-CoV-2, but belongs to the same family of coronaviruses. Daikin device MCK55WVM (commercial name MCK55W), tested by Institut Pasteur de Lille, removes 99.986 % of Influenza A virus subtype H1N1 in 2.5 minutes running time at 'turbo' speed in laboratory conditions (air-tight chamber with inner volume 0.47 m³, no air renewal). Daikin device MCS55WVM (commercial names MCS55W/VB), tested by Institut Pasteur de Lille, removes 99.93 % of Influenza A virus subtype H1N1 in 2.5 minutes running time at 'turbo' speed in laboratory conditions (air-tight chamber with inner volume 0.47 m³, no air renewal).

Installer service



E-Care app



The Daikin e-Care app wants to make the life of a Daikin installer easier by offering Stand By Me registrations via QR code scanning, easy configuration of your heating installation and trouble-shooting via the e-Doctor part.

NEW

Order your **spareparts** directly via the e-Care app, update the settings of your installation with a **Wifi USB** stick and avoid any possible mistake during commissioning of your installation thanks to the easy guidance of the **Commissioning Assistant**.

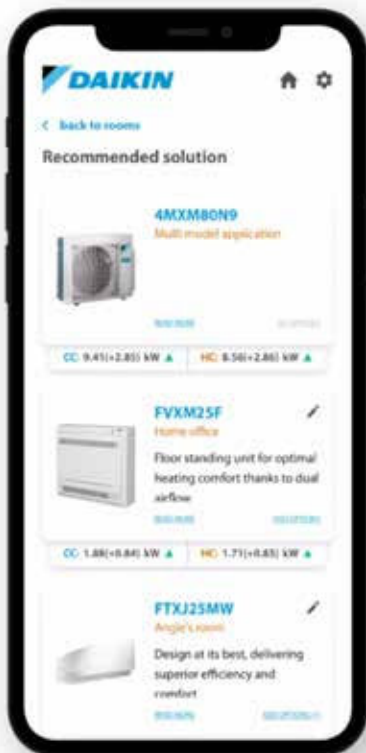

Multi Split selection software

Make an accurate selection of your Daikin Multi Split system in a few steps!

Easy web-based selection tool for our multi split range. It allows to choose the most designated system for each customer's individual needs.

- 1 Sign in with your Daikin ID
- 2 Create a new project or choose one of your previously created projects
- 3 Enter your project details
- 4 Enter the building details
- 5 Add rooms
- 6 The best solution is proposed



Go to multi.daikin.eu and watch the instruction video



Stand By Me, my climate of security

With your customer's new Daikin installation and Stand By Me service programme, you can rest assured they are benefiting from the best comfort, energy efficiency, usability and service available on the market.



Free warranty extension



The first advantage of **Stand By Me** is a free warranty extension:

- applies to both labour and parts
- begins immediately after registration



Quick follow-up by Daikin service partners

Daikin service partners are automatically notified when a customer registers their installation on www.standbyme.daikin.eu and needs maintenance.

Your customer is guaranteed:

- quick and reliable service
- management of all information related to their installation such as, registration documents, attendance records, maintenance records, etc.
- immediate access to the correct information contributes to flawless service



Extended warranty on parts

For a small fee, customers can extend the warranty on specific parts. **Stand By Me** guarantees:

- that each component is replaced quickly
- helps avoid financial surprises
- long life and smooth operation and all other benefits of a Daikin installation
- reliable service from official Daikin service partners

Daikin service partners work exclusively with Daikin parts and have all of the necessary technical knowledge to solve any issue that may arise

Register
your Daikin unit:
www.standbyme.daikin.eu

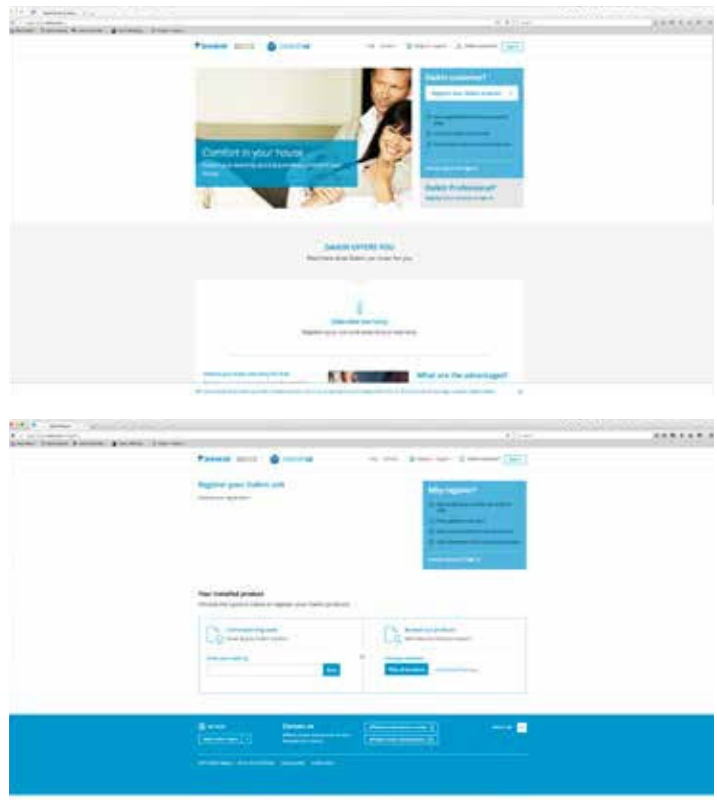



NEW

DCS Lite

From the professional portal, installers can activate the remote monitoring allowing them to supervise your installation on multiple parameters, from their location. They will get an automatic notification in case there is something wrong with the installation. By changing certain settings they can improve your comfort immediately. Save time and get a better support, thanks to these new features.

How to access?

Through the e-care app and SBM Pro portal.

What to expect

Remote monitoring and servicing of split products, after consent from the end user.

- › Control your customer's unit and change settings.
- › Read out temperature, energy consumption and error codes.

	Description	DCS lite
CONTROL	Unit on/off	•
	Operation mode	•
	Temperature set point	•
	Fan speed	•
	Econo mode	•
	Schedules	•
	Flash streamer	•
	Powerful mode	•
	Comfort	•
	Horizontal swing	•
	Vertical swing	•
	Demand control	•
	Holiday mode	•
	INFO	Indoor temperature
Outdoor temperature		•
Energy consumption		•
Error state & code		•
Adapter model number		•
Adapter serial number	•	

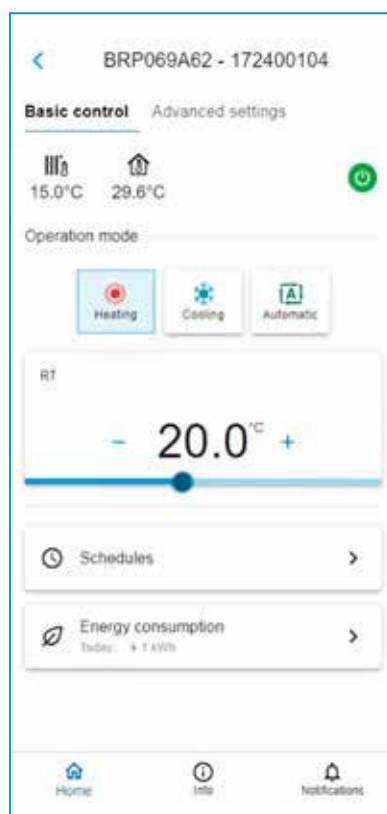

Adjust a room setpoint remotely

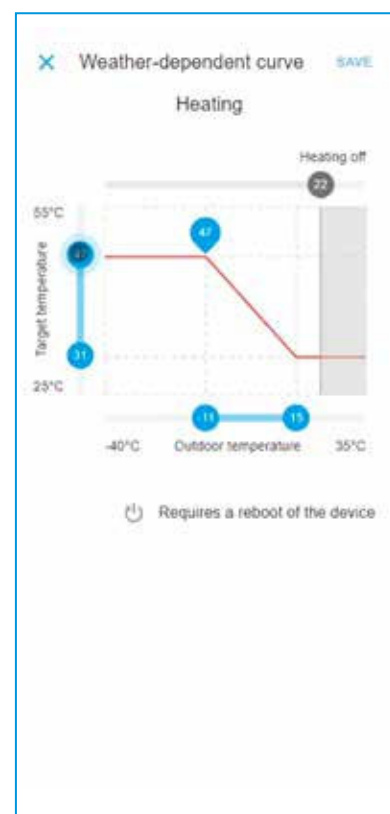

Adjust the weather-dependent curve remotely

Connectivity

The Onecta app can control and monitor up to 50 split air conditioning units.

All Bluevolution units are connectable with the Onecta app.

Control

Control operation mode, temperature, air purification, fan speed & direction



Schedule

Schedule the set temperature, operation mode and fan speed

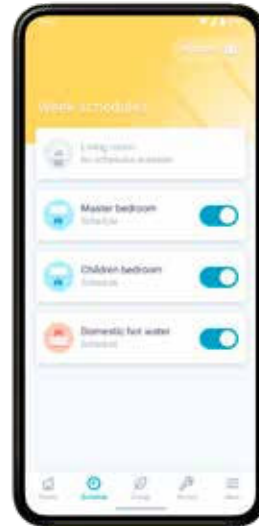

Monitor

Monitor your energy consumption, set holiday schedule

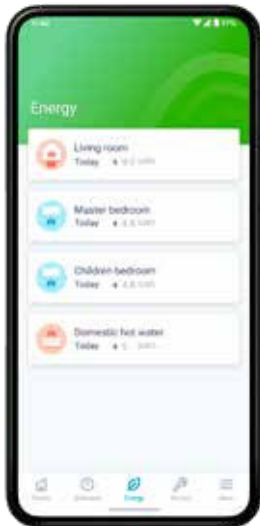

Identify

Identify the rooms of your house

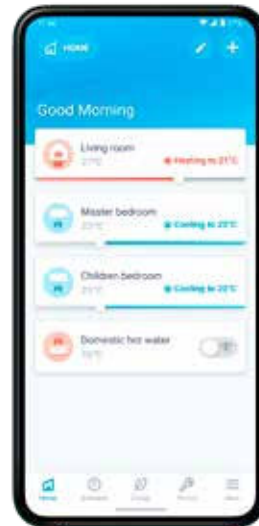

Intuitive online and voice control

Control your system and enjoy maximum comfort, just by using your voice. Via Amazon Alexa or Google Assistant you can control main functions such as temperature set point, operation mode, fan speed, and much more!

Your benefits

- > Access to various features for controlling your internal climate
- > Manage the temperature, operating mode, air purification and fans with the interactive thermostat
- > Create different operating schedules and modes
- > Monitor energy consumption

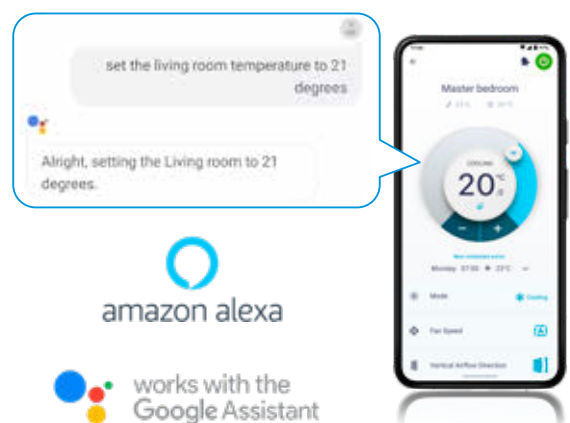



Multi

A Daikin multi split system offers you unexpected possibilities in creating a comfortable and cosy home. This is your solution to reduce limitations like environmental impact and financial aspects.

Choose between 2 options

Multi
for cooling and heating
(up to 5 indoor units)

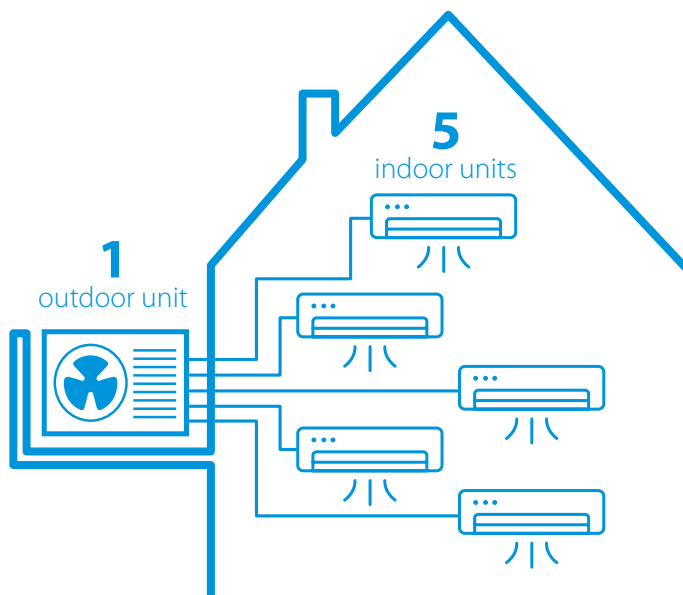

NEW Multi+
for cooling, heating and hot water
Connect **Multi+ outdoor unit** with up to 3 indoor units and a 90 l or 120 l tank to provide domestic hot water

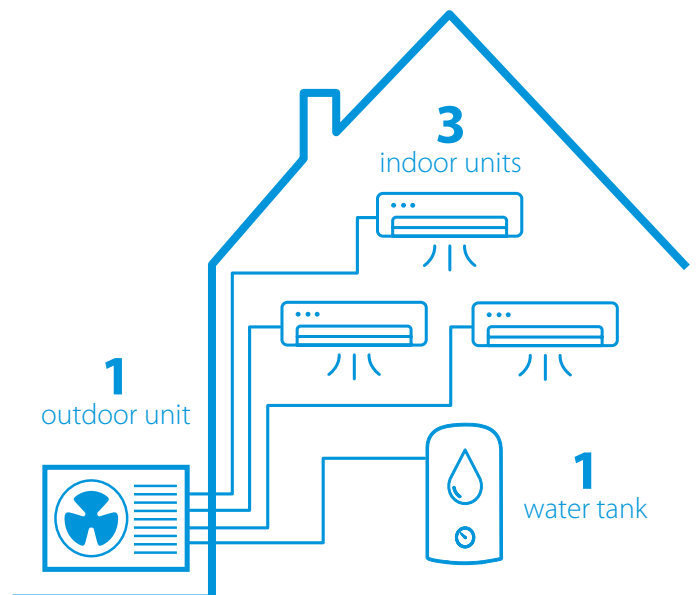

Less mounting space, less visibility, less sound



SAVE SPACE

Drastically reduce the space required for placing a number of units on your facade.



LESS VISIBILITY

Enjoy your nice ambience. Finding just one hiding place is much easier.



LESS NOISE

Only one unit in operation is much quieter than two or more units.

Easier installation, wiring, piping and maintenance



SAVE MOUNTING EQUIPMENT

Wherever you want to place an outdoor unit, for every unit you will need correct mounting equipment for a secure fixing and problem-free operation.



SAVE TIME

The physical installation, wiring, drain piping as well as the initial setup of only one system is much easier and faster.



REDUCED CHANCE OF TECHNICAL ERRORS

When using only one outdoor unit instead of two or more, the statistical probability of a possible technical defect is reduced with every unit that you do not need.

More flexibility: connect up to 5 indoor units of any style

There are many possibilities in comfort you can profit from a multi split solution:



Up to 5 indoor units connectable to **only one outdoor** unit



Every single indoor unit can be **regulated separately**



Choose from a **greater variety** of connectable indoor unit types out of our split and Sky Air series



Use **low capacity** indoor units specially designed for small rooms which can only be connected to a multi split system



Are you planning an additional indoor unit later on? Just **decide now** for an outdoor unit with higher capacity and simply **connect it later**.

Lower power consumption, high efficiency



Our big compressors can work more efficiently than various smaller ones with the same capacity in sum. Also save a significant proportion of energy thanks to standby mode.

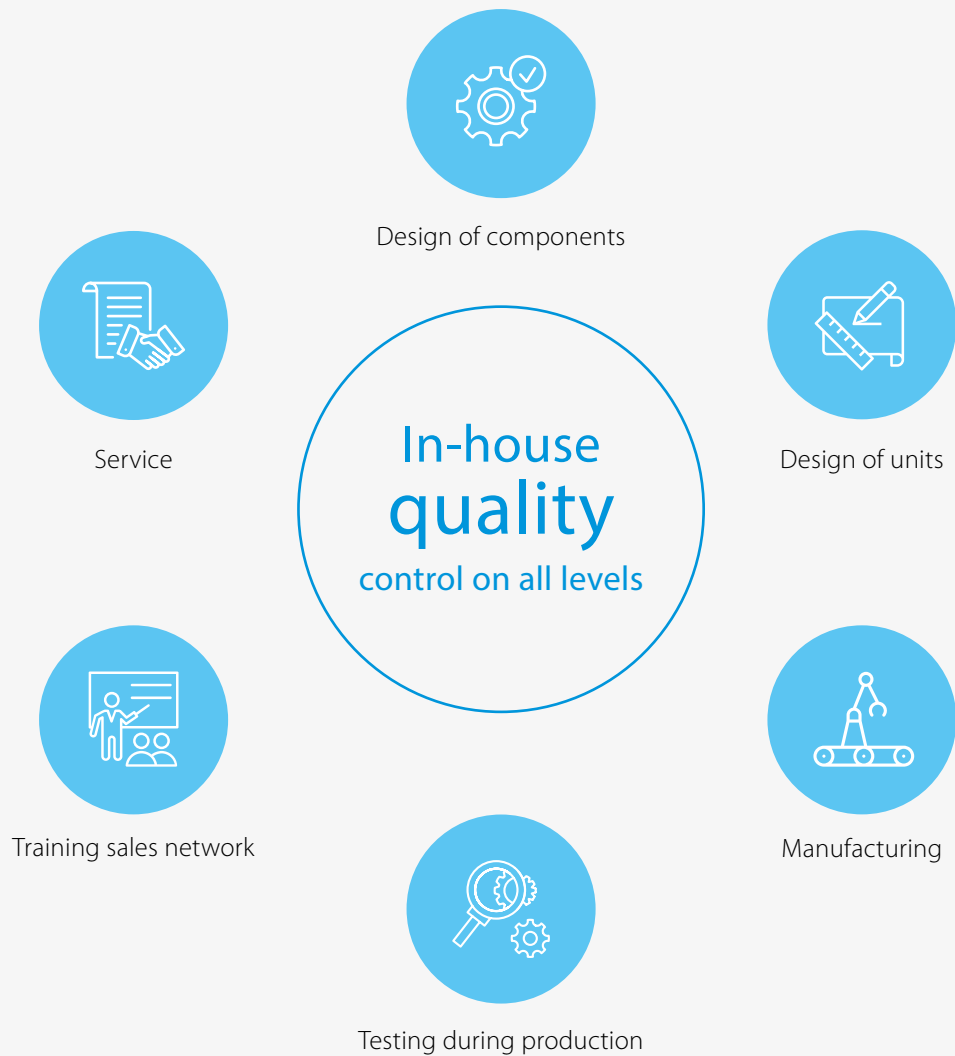

Quality

Innovation and quality have always been keystones of Daikin philosophy. We strongly believe that by offering the best products, we can maintain our success. Daikin's quality is continuously reinforced by the intensive training of our sales network and improvements in our products and production processes. Quality begins at the design phase. Manufacturing our own compressors, refrigerants, and other major components allows us design quality control into our products from the beginning.



Daikin 3D app for end-users

Daikin 3D app is the application that allows you to choose the air conditioning and watch it at home BEFORE you buy it!

With the Daikin 3D app you can **virtually place** an air conditioner in your own interior.

Switch on the device, get close, look from every angle, add dimensions and take a photo so that you can easily compare all the different Daikin options.

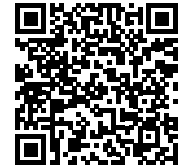

Product range
Choose the desired device



Product detail
Consult the technical data sheets and find additional information



3D visualisation
Customize the size, colour, rotate and move the air conditioning to your liking



Best comfort through intelligent sensors and airflow techniques



Low sound

Our indoor units are almost inaudible to hear with sound levels down to 19dBA thanks to high-end airflow techniques and in-house developed fans.

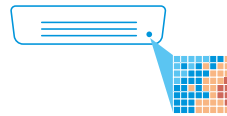

Intelligent thermal sensor

Stylish FTXA uses an intelligent thermal sensor to detect the surface temperature of a room to create a more comfortable climate by directing the airflow that requires cooling or heating.

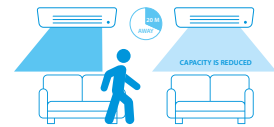

2-area motion detection sensor

Air flow is sent to a zone other than where the person is located at that moment. If no people are detected, the unit will automatically switch over to the energy efficient setting.

NEW In addition, a special software is developed on a range of outdoor units* to lower the sound level if required by legislation. For more information, please contact your local sales office.

* RXM20-35R9, RXA20-35A9, RXJ20-35A, 2MXM40-50A, 3MXM40-52A, 2AMXM40-50A

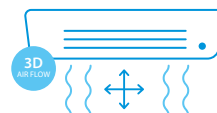

3-D air flow

Combines vertical and horizontal auto-swing to circulate a stream of warm or cool air right to the corners of even large spaces.

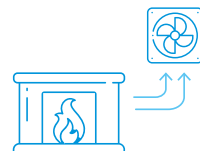

Fireplace logic

When installed close to a heating device (e.g. fireplace or oven) and the set temperature is reached, the fan keeps on running to have an even temperature throughout the whole house (Applicable for optimised heating FTXTM-R and FTXTA-BW/BB)



Iconic and award winning designs

Our Stylish and Ururu Sarara have earned several awards for their innovative look and functional capabilities.



reddot design award
winner 2013



White FTXA-AW



Silver FTXA-BS



**GOOD
DESIGN**



**DESIGN
AWARD
2018**



Blackwood FTXA-BT



Black FTXA-BB



reddot award 2018
winner

What's new



Daikin Emura

Design that speaks for itself

FTXJ-AB/AS/AW

- p. 24 **NEW** > Available in white, silver and black
> Simplified remote control with focus on most important functions
> New design grill outdoor unit, both for pair and multi

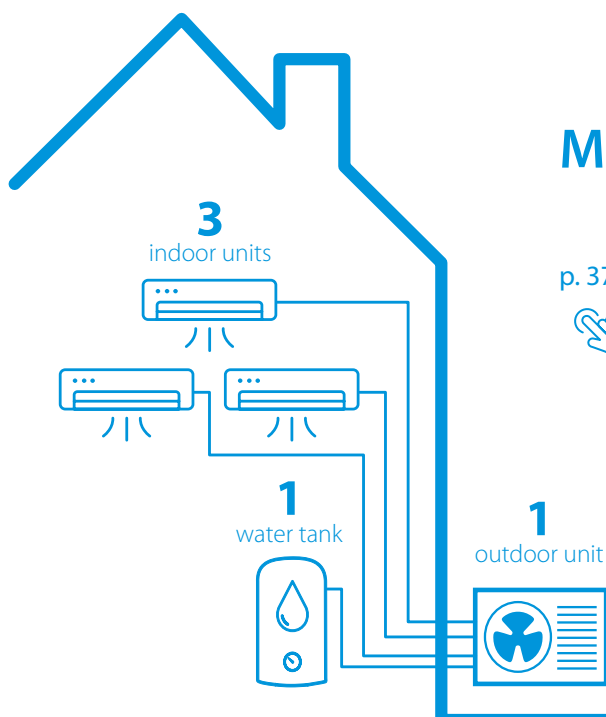

Multi +

- p. 37 **NEW** > Combine multi with domestic hot water in one system



COMING SOON
AVAILABLE FROM
MAY 2022

Sensira

FTXQ-A

- p. 31 **NEW** › Flat, stylish front panel blends easily within any interior décor and is easier to clean
- › Seasonal efficiency values up to A++ in cooling
 - › Onecta app (optional): control your indoor from any location with an app, via your local network or internet.



Optimised heating

- p. 54 **NEW** › Stylish unit now available in black
- › New Perfera outlook
 - › Updated Comfora with standard WLAN adapter
 - › Guaranteed capacity down to -25°C



FTXTA-BB



FTXTM-R



FTXTP-M





Ururu Sarara

The best of the best

Why choose Ururu Sarara?

The Daikin Ururu Sarara brings a new level of sophisticated control to air conditioning. It has five air treatment techniques which together provide a total comfort solution. In addition, the Ururu Sarara range has SEER and SCOP **A++** ratings thanks to its energy efficient compressor and heat exchanger. Because of its innovative technology, as well as its design, it won the prestigious Red Dot design award.



reddot design award
winner 2013



5 air treatment techniques



Heating and cooling in one unit, for year-round comfort with the highest energy label available



In winter, the Ururu function replenishes the moisture in the air to maintain a comfortable feel without unnecessary heating



In summer, the Sarara function removes excess moisture while maintaining an even temperature thus eliminating the need for extra cooling



Ventilation for fresh air even with closed windows

Air purification



Flash streamer

Using electrons to trigger chemical reactions with airborne particles, the Flash Streamer removes allergens such as pollen and fungal allergens, eliminating unpleasant odours and providing better, cleaner air.



Titanium apatite deodorising filter

Decomposes bothersome odours of for example tobacco and pets.

TITANIUM APATITE DEODORISING FILTER

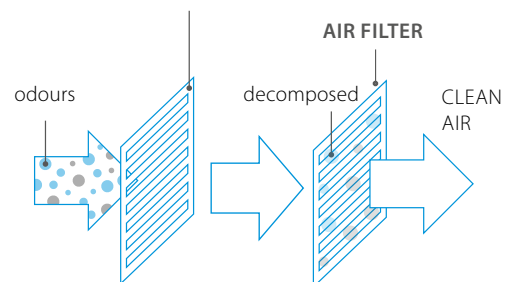

Self-cleaning filter

The air filter removes airborne dust particles from the air while the integrated brush regularly and automatically cleans the filter to ensure a steady supply of clean air.



Daikin Emura

Design that speaks for itself



Why choose Daikin Emura?

- › Ultimate comfort, designed with the highest **quality** in mind ... Its design speaks for itself: Daikin Emura pleases the eye and has a strong focus on comfort and user experience to improve your well-being at home.
- › When you choose Daikin technology, you can count on year-round **comfort, energy efficiency, reliability** and **control**.







High energy efficiency

Seasonal efficiency gives a more realistic indication on how efficient air conditioners operate over an entire heating or cooling season. The label includes multiple classifications from A+++ to G. Daikin Emura achieves high energy efficiencies:

- › SEER up to
- › SCOP up to



Benefits

-  Almost inaudible with sound levels down to 19 dBA
-  3D airflow
-  Intelligent thermal sensor
-  Heat boost
-  Weekly timer
-  Onecta app: always in control no matter where you are, including voice control
-  Connectable to pair, multi and VRV



Unique design

Silver, matt white and matt black, these are the three monochrome colours in which the Daikin Emura air conditioner is available.



The front panel of the remote control matches the colours of the indoor unit – the casing is anthracite grey to create a floating effect.



The outdoor unit comes in ivory white.



Comfort

Intelligent thermal sensor

Daikin Emura uses an intelligent thermal sensor to detect a room's current temperature. After determining the room temperature, the intelligent thermal sensor distributes air evenly throughout the room before switching to an airflow pattern that directs warm and cool air to areas that need it.

3D airflow

Combines vertical and horizontal auto-swing to circulate a stream of warm or cool air right to the corners of even large spaces.

Inaudible to hear

Daikin Emura is almost inaudible with sound levels down to 19 dBA.

Coanda effect

By using specially designed flaps, a more focused airflow allows a better temperature distribution throughout the whole room.

Heat boost

Daikin Emura quickly heats the room when starting up, ensuring the set temperature is reached faster.

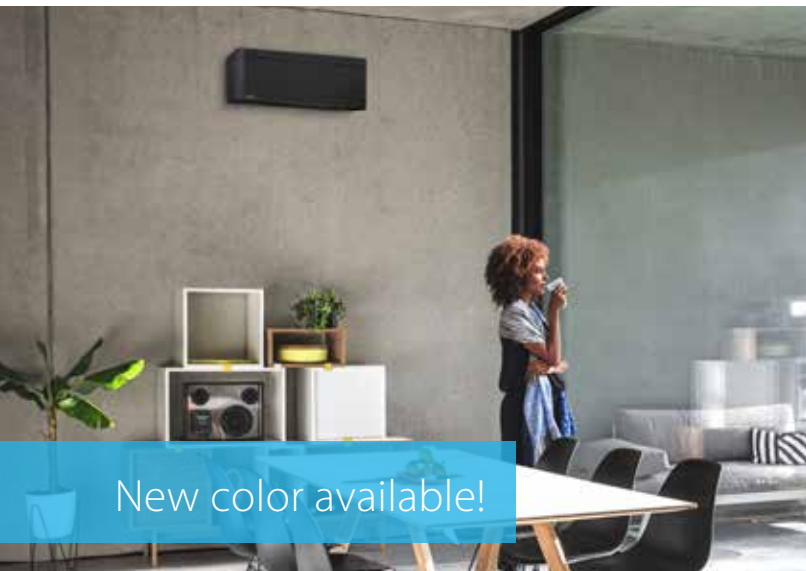

New color available!



Stylish

where innovation meets creativity



White FTXA-AW



Silver FTXA-BS

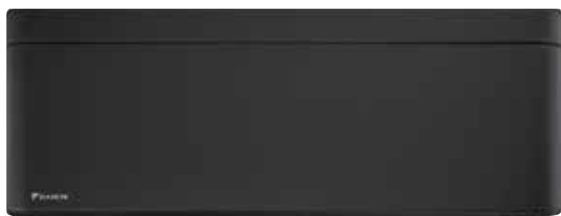

Black FTXA-BB



Blackwood FTXA-BT

up to



in heating & cooling

Available in 4 colours

- › Users can choose from **four distinct colours** (white, silver, black and blackwood)
- › **Curved corners** create an unobtrusive and space-saving design
- › **Thin dimensions** make it the most compact design unit on the market
- › Simple panel enables variation in texture and colour to easily blend into any room
- › Award winning design: Stylish earned the Reddot award, the Good Design Award and iF award for its innovative look and functional capabilities



reddot award 2018
winner



GOOD DESIGN
AWARD 2017

The Coanda effect

Already present in the Ururu Sarara, the **Coanda effect** optimises the airflow for a comfortable climate. By using specially designed flaps, a more focused airflow allows a better temperature distribution throughout the whole room.

The Coanda effect creates two different airflow patterns depending on whether Stylish is in cooling or heating mode. On the top is the Coanda effect in cooling mode (ceiling airflow), while the bottom images demonstrate the Coanda effect in heating mode (vertical airflow).

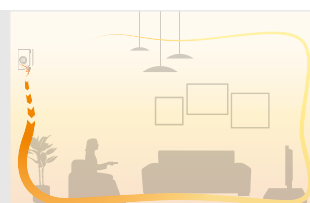
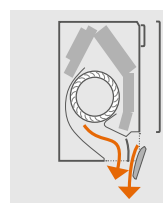
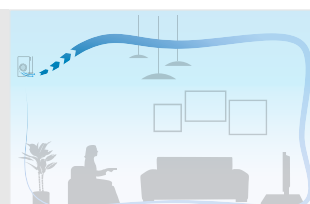
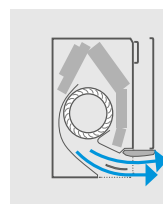
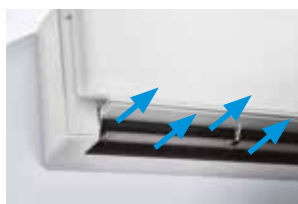

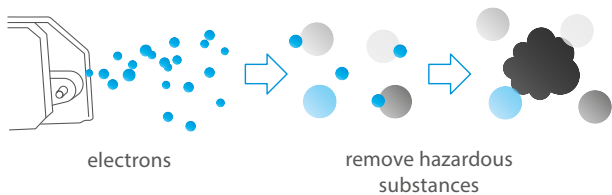

Air quality

Flash streamer: using electrons to trigger chemical reactions with airborne particles, the Flash Streamer removes allergens such as pollen and fungal allergens, eliminating unpleasant odours and providing better, cleaner air.

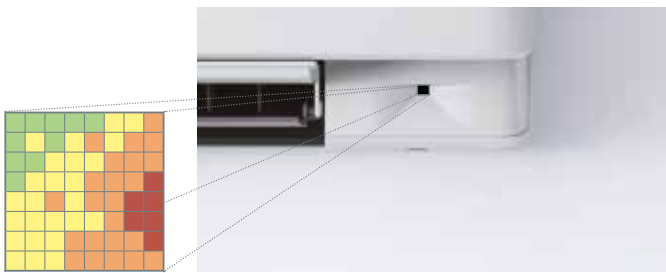

Intelligent thermal sensor

Stylish uses an **intelligent thermal sensor** to detect the surface temperature of a room to create a more comfortable climate. After determining the current room temperature, the grid eye sensor distributes air evenly throughout the room before switching to an airflow pattern that directs warm or cool air to areas that need it.

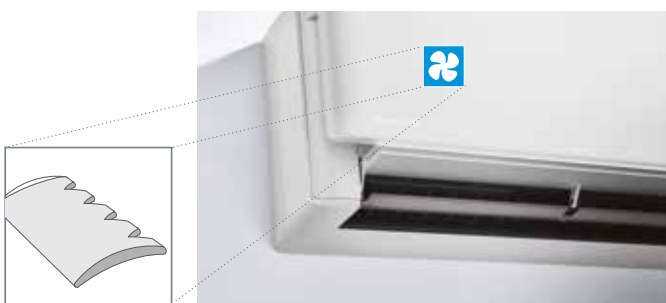

Quiet operation

Stylish uses a **specially designed fan** to optimise airflow for higher energy efficiency at low sound levels. To achieve higher energy efficiency, Daikin designed a fan that runs efficiently within Stylish's compact dimensions. Together, the fan and heat exchanger attain top energy performance but operate at a sound level that is practically inaudible to occupants.

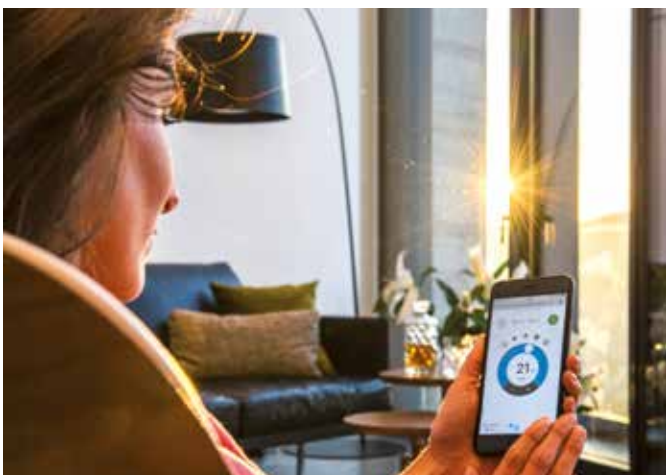

Onecta app

Control your system and enjoy maximum comfort, just by using your voice. Via Amazon Alexa or Google Assistant you can control main functions such as temperature set point, operation mode, fan speed, and much more!

Your benefits

- › Access to various features for controlling your internal climate
- › Manage the temperature, operating mode, air purification and fans with the interactive thermostat
- › Create different operating schedules and modes
- › Monitor energy consumption

The perfect solution

for a comfortable home



Perfera wall mounted unit

makes cool living and working a breeze

Whatever the weather's doing outside, inside you want optimum comfort throughout the day. Like a cool summer breeze, Perfera instinctively knows how to keep the room temperature in your living or working space at the ideal level, so that you and those around you can get on with relaxing, enjoying yourselves – and being productive. The stylishly designed front panel, whisper-quiet operation and the perfect circulation of cooled or heated air help make each room the place you – and everyone – always want to be.

Intelligent - Comfortable - Quiet

3-D 3-D Air flow

By pressing the buttons on the remote control, this function combines vertical and horizontal auto-swing to circulate a stream of cool/warm air right to the corners of even large spaces.



2-area motion detection sensor

Air flow is sent to a zone other than where the person is located at that moment. If no people are detected, the unit will automatically switch over to the energy efficient setting.

Silent operation

Perfera uses a **specially designed fan** that optimises airflow and creates high energy efficiency at low sound levels. For even higher energy efficiency, Daikin has also designed a new fan that fits snugly into Perfera's compact dimensions.

Together, the fan and heat exchanger produce top energy performance, yet operate at a sound level that is practically inaudible. Shhh!





Air quality

Flash streamer/ titanium apatite deodorising filter

Flash streamer: using electrons to trigger chemical reactions with airborne particles, the Flash Streamer removes allergens such as pollen and fungal allergens, eliminating unpleasant odours and providing better, cleaner air.

And the titanium apatite deodorising filter works hard to combat smells such as tobacco smoke and pets.

FLASH STREAMER

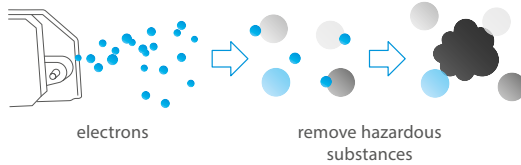

TITANIUM APATITE DEODORISING FILTER

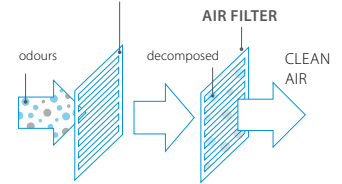

Silver allergen removal filter

The Silver allergen removal and air purifying filter is your solution, because it captures allergens such as pollen to ensure a steady supply of clean air.

Energy efficiency

The enhanced design of the Perfera boosts energy efficiency even further compared with previous models. It boasts a seasonal energy efficiency ratio (SEER) of up to 8.65 and a seasonal coefficient of performance (SCOP) of up to 5.10. This gives the Perfera **best-in-class performance**, with seasonal efficiency values up to A+++ in cooling and heating resulting in low running costs.

The Perfera is an energy-saving winner from every angle.



Heat boost

Heat boost quickly heats up your home when starting up your air conditioner. Set temperature is reached 1.4% faster* than a regular air conditioner (pair only).

*Heat Plus test condition: 50 class, outdoor temperature 2°C - Indoor temperature 10°C, R/C setting: 23°C

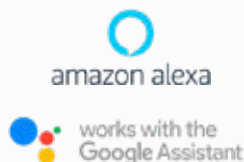
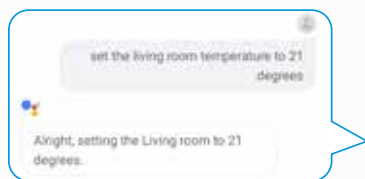

Intuitive online and voice control

NEW Control your system and enjoy maximum comfort, just by using your voice. Via Amazon Alexa or Google Assistant you can control main functions such as temperature set point, operation mode, fan speed, and much more!



Comfora

Discreet wall mounted unit for high efficiency & comfort

Why choose Comfora?

up to

A++ in cooling

A++ in heating

BLUEEVOLUTION

R-32

Efficiency

Choosing for an R-32 product, reduces the environmental impact with 68% compared to R-410A and leads directly to lower energy consumption thanks to its high energy efficiency.

Seasonal efficiency values up to A++ in cooling and heating.

Comfort

3-D air flow combines vertical and horizontal auto swing to circulate a stream of warm or cool air right to the corners of even large spaces.

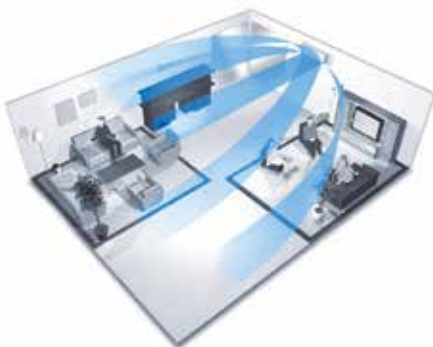

Onecta app

Control your indoor from any location with an app, via your local network or internet.

NEW Voice command via Amazon Alexa or Google Assistant to control main functions such as set point, operation mode, fan speed, etc.



Silver allergen removal and air purifying filter

Silver allergen removal and air purifying filter: captures allergens such as pollen to ensure a steady supply of clean air.



Low sound down to 19 dBA

Whisper quiet in operation: the operating of the unit can hardly be heard. The sound pressure level goes down to 19 dBA.



Sensira

Refreshingly new

Why choose Sensira?



BLUEEVOLUTION

R-32

High Efficiency

Creating a fresh climate at home is about more than just pure comfort. Daikin systems are easy on your wallet and good for the environment, too. The next-generation refrigerant R-32 and optimised compressors make sure you stay in your comfort zone.

Our products' low energy consumption means lower energy bills for you reaching the highest energy efficiency levels.

Sound

With sound pressure down to 20 dBA, the Sensira operates almost unnoticed ensuring a good night's sleep.

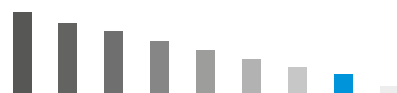

Clean Air

The **titanium apatite deodorising filter** decomposes bothersome odours of for example tobacco and pets. (FTXC-C only)

The **air filter** removes airborne dust particles to ensure a steady supply of clean air.



Onecta app

Intuitive online and voice control

NEW Control your system and enjoy maximum comfort, just by using your voice. Via Amazon Alexa or Google Assistant you can control main functions such as temperature set point, operation mode, fan speed, and much more!



Creating the perfect indoor climate is what Daikin units are all about. These wall mounted units are discreet and create a comfortable atmosphere with lower energy use.



Go with
the heating flow

Perfera floor standing unit

makes your world comfortable

Whatever you're planning to do with your day, you want to be comfortable while you're doing it. Whether it's the coolness of a summer breeze or the cosiness during winter, your living space needs that delicious feeling of wellbeing all year round. Perfera is unobtrusive and features a stylishly designed front panel, whisper-quiet operation and reduced airflow, turning each room into a true haven of conspicuous comfort.



Comfortable: dual airflow

Easier individual control of airflow

The dual airflow of the Perfera floor-standing unit is perfect for creating the ideal level of heating. Air is directed both upwards and downwards to deliver even warm air distribution. And when the Perfera is in heat mode, your feet stay warm and the temperature throughout the room is evenly distributed, guaranteeing maximum comfort. Sheer bliss!

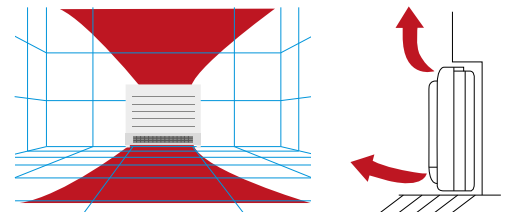

Silent operation

Perfera uses a specially designed turbo fan that optimises airflow and creates high energy efficiency at low sound levels.

up to
A++
in cooling

up to
A+++
in heating



Air quality

Flash streamer/titanium apatite deodorising filter

Flash streamer: using electrons to trigger chemical reactions with airborne particles, the Flash Streamer removes allergens such as pollen and fungal allergens, eliminating unpleasant odours and providing better, cleaner air. And the titanium apatite deodorising filter works hard to combat smells such as tobacco smoke and pets.

Installation

Whether **built-in** or **wall-mounted**, the Perfera blends into the background and fits into your interior without any problem.



3 unique heating features



Heat boost

Heat boost quickly heats up your home when starting up your air conditioner. Set temperature is reached 14% faster* than a regular air conditioner (pair only).

*Heat Plus test condition: 50 class, outdoor temperature 2°C - Indoor temperature 10°C, R/C setting: 23°C



Floor warming

The floor warming function optimises convection by distributing hot air from the bottom of the unit.



Heat plus

The heat plus function provides cosy heating by simulating radiant heat for 30 minutes. Afterwards, the previous settings are again activated.

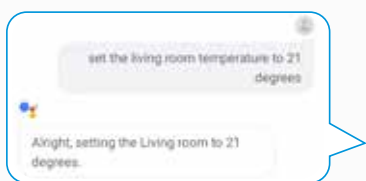

Intuitive online and voice control

NEW Control your system and enjoy maximum comfort, just by using your voice. Via Amazon Alexa or Google Assistant you can control main functions such as temperature set point, operation mode, fan speed, and much more!

FDXM-F9

Compact concealed ceiling unit,
with a height of only 200mm

- › Invisible unit as the unit is concealed in the ceiling: only the suction and discharge grilles are visible
- › Improved in-room air quality, higher efficiency and lower maintenance costs as dust can easily be removed with a vacuum cleaner (self cleaning kit option)
- › Compact dimensions, can easily be mounted in a ceiling void of only 240mm

Auto cleaning filter option

Filter cleaning takes place automatically with the timing set via the remote control. The dust is collected in a dustbox integrated in the unit. Once full dust can be removed easily via a vacuum cleaner without opening the unit.

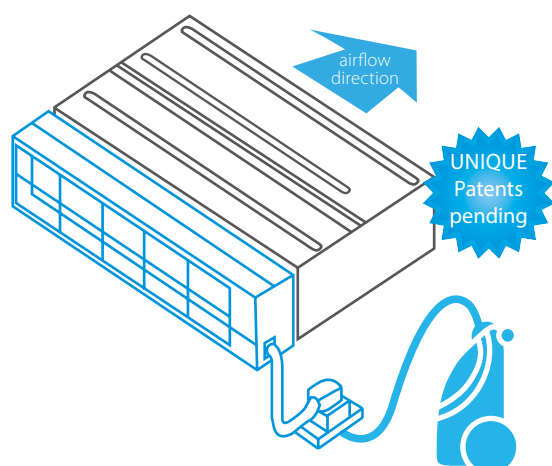

- › Onecta app (optional): control your indoor with voice control and from any location with an app, via your local network or internet and keep an overview on your energy consumption
- › Low energy consumption thanks to DC fan motor

Multi zoning: supply multiple room with one indoor unit

The zoning kit increases the flexibility of Split, Sky Air and VRV system applications by allowing multiple individually-controlled climate zones to be served by one indoor unit

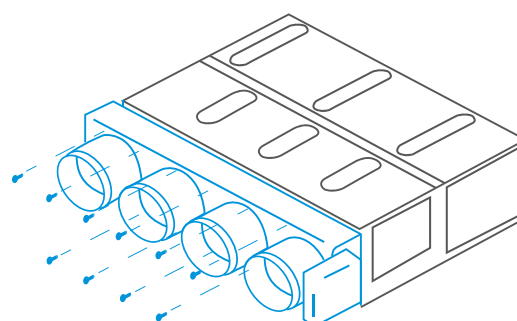

Plug and play plenum



up to

A⁺

in cooling

up to

A⁺

in heating



FTXJ-AW



FTXM-R



FVXM-A



FTXA-AW

Less is
more

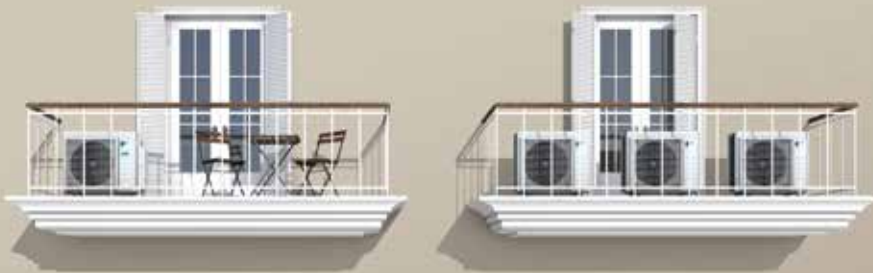

Multi Split Simply extend your comfort!

A Daikin multi split system offers you unexpected possibilities in creating a comfortable and cosy home. This is your solution to reduce limitations like environmental impact and financial aspects.

Less mounting space, less visibility, less sound

- › **Save space:** Drastically reduce the space required for placing a number of units on your facade
- › **Less visibility:** Enjoy your nice ambience. Finding just one hiding place is much easier
- › **Less noise:** Only one unit in operation is much quieter than two or more units

Lower power consumption, high efficiency

- › **Less power consumption:** Our big compressors can work more efficiently than various smaller ones with the same capacity in sum. Also save a significant proportion of energy thanks to standby mode

Pair split or multi split combination –
the direct system comparison

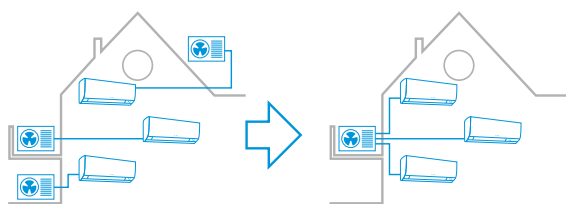

Conventional pair split
installation for air-
conditioning three rooms

Solution for the same
situation with only
one multi split outdoor unit

Easier installation, wiring, piping and maintenance

- › **Save mounting equipment:** Wherever you want to place an outdoor unit, for every unit you will need a mounting for a secure fixing and problem-free operation
- › **Save time:** The physical installation, wiring, drain piping as well as the initial setup of only one system is much easier and faster
- › When using only one outdoor unit instead of two or more, the statistical probability of a **possible technical defect is reduced** with every unit that you do not need.

More flexibility: Connect up to 5 indoor units of any style

There are many possibilities in comfort you can profit from a multi split solution:

- › **Up to 5 indoor units** connectable to only one outdoor unit
- › Every single indoor unit can be **regulated separately**
- › Choose from **a greater variety** of connectable indoor unit types out of our split and Sky Air series
- › Use low capacity indoor units specially **designed for small rooms** which can only be connected to a multi split system
- › Are you planning an **additional indoor unit later on?** Just decide now for an outdoor unit with higher capacity and simply connect it later



AIR CONDITIONING



HOT WATER

= MULTI+

Coming soon
SPRING 2022

NEW

Multi+

for cooling, heating
and hot water

Connect **Multi+ outdoor unit**
with up to 3 indoor units and
a 90 l or 120 l tank to provide
domestic hot water

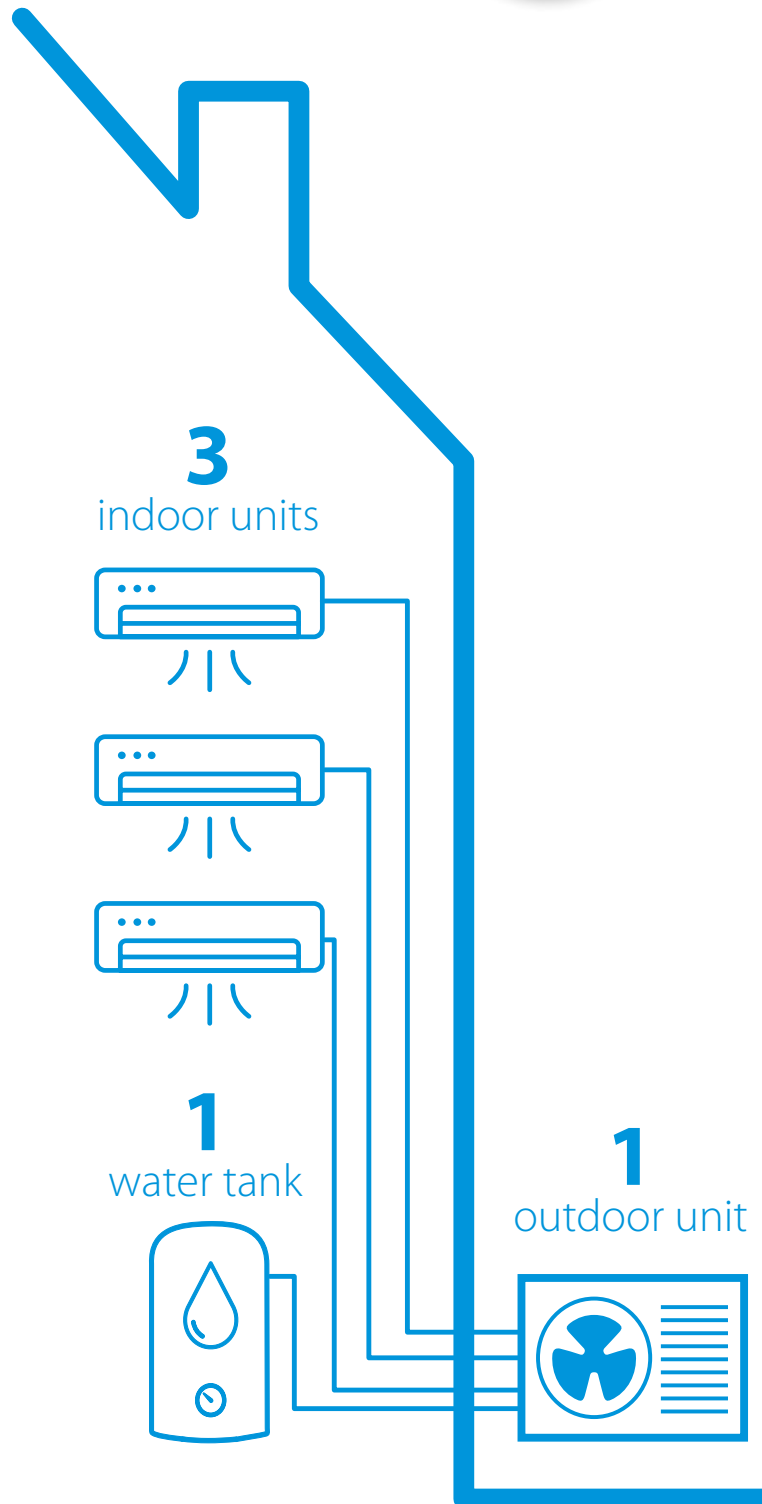

NEW

Design multi outdoor unit
for the full range



Split

Standard range

Wall mounted

		NEW			UPDATE			NEW	
	FTXZ-N	FTXJ-AW/S/B	C/FTXA-AW/BS/BT/BB	C/FTXM-R	FTXP-M(9)	FTXF-D	CTXF-C / FTXF-B multi only	FTXC-C	FTXQ-A
We care	Econo mode	•	•	•	•	•	•	•	•
	2-area motion detection sensor		•		•				
	3-area motion detection sensor	•							
	Energy saving during operation standby	•	•	•	•	•	•	•	•
	Home leave operation								
	Night set mode		•	•	•	•			•
	Fan only	•	•	•	•	•	•	•	•
	Auto cleaning filter	•							
Comfort	Comfort mode	•	•	•	•	•	•		•
	Powerful mode	•	•	•	•	•	•	•	•
	Auto cooling-heating changeover	•	•	•	•	•	•	•	•
	Whisper quiet (down to 19dBA)	•	•	•	•	•			
	Practically inaudible		•	•	•	•			
	Indoor unit silent operation	•	•	•	•	•	•		•
	Comfortable sleeping mode	•						•	
	Outdoor unit silent operation	•	•	•	•				
	Fire place logic								
	Heat boost				•				
	Heat plus								
Floor warming									
Air flow	3-D Air flow	•	•	•	•				
	Vertical auto swing	•	•	•	•	•	•	•	•
	Horizontal auto swing	•	•	•	•				•
	Auto fan speed	•	•	•	•	•	•	•	•
	Fan speed steps	5	5	5	5	5	3	3	5
	Intelligent thermal sensor			•					
	Coanda Effect	• (cooling only)		• (cooling and heating)					
Humidity control	Ururu - humidification	•							
	Sarara - dehumidification	•							
	Dry programme		•	•	•	•	•	•	•
Air treatment	Flash Streamer**	•		•	•				
	Titanium apatite deodorising filter	•	•	•	•	•		•	
	Silver allergen removal and air purifying filter		•	•	•	•			
	Air filter	•	•	•	•	•	•	•	•
Remote control & timer	Onecta app	•*	•	•	•	•*	•*	•*	•
	Weekly timer		•	•	•				
	24 Hour timer	•	•	•	•	•	•	•	•
	Infrared remote control	•	•	•	•	•	•	•	•
	Wired remote control		•*	•*	•*				
	Centralised remote control	•	•	•	•				
Other functions	Multi zoning								
	Auto-restart	•	•	•	•	•	•	•	•
	Self-diagnosis	•	•	•	•	•	•	•	•
	Multi model application		•	•	•	•	•	•	•
Guaranteed operation down to -25°C					20,25,35 class	20,25,35 class			

* Available as option

** The Flash Streamer technology is not meant to be used for medical purposes

		Optimised heating range				
Concealed ceiling	Floor standing		Wall mounted			Floor standing
	C/FVXM-A	FVXM-F	NEW FTXTA-BW/BB	NEW FTXTM-R	UPDATE FTXTP-M	
FDXM-F9	C/FVXM-A	FVXM-F	FTXTA-BW/BB	FTXTM-R	FTXTP-M	FVXM-A
	•	•	•	•	•	•
				•		
	•		•	•	•	•
•	•	•	•	•	•	•
•	•	•	•	•	•	•
•*	•	•	•	•	•	•
			•	•	•	
	•	•	•	•	•	•
	•	•	•	•	•	•
	•	•	•	•	•	•
	•	•	•	•	•	•
	•	•	•	•	•	•
	•	•	•	•	•	•
	•	•	•	•	•	•
	•	•	•	•	•	•
	•	•	•	•	•	•
	•	•	•	•	•	•
	•	•	•	•	•	•
	•	•	•	•	•	•
3	5	5	5	5	5	5
			•			
			•			
•	•	•	•	•	•	•
	•		•	•		•
	•	•	•	•	•	•
•	•	•	•	•	•	•
•*	•	•*	•	•*	•*	•
•	•	•	•	•		•
•	•	•	•	•	•	•
•	•	•	•	•	•	•
•*	•	•	•*	•*		•
•	•	•	•	•	•	•
•	•	•	•	•	•	•
•	•	•	•	•	•	•
•	•	•	•	•	•	•
•	•	•	•	•	•	•
•	•	•	•	•	•	•
•	•	•	•	•	•	•
•	(2 and 3 port)	•	•	•	•	•



Wall mounted unit

Complete climate control with (de) humidification, air purification & ventilation with top efficiencies in heating & cooling

- › Unique combination of humidification, dehumidification, ventilation, air purification and heating & cooling in 1 system
- › 3 area motion detection sensor: air flow is sent to a zone other than where the person is located at that moment. Detection is done in 3 directions: left, front and right. If no people are detected, the unit will automatically switch over to the energy-efficient setting
- › No need to clean filters, thanks to the self cleaning filter
- › Voice command via Amazon Alexa or Google Assistant to control main functions such as set point, operation mode, fan speed, etc
- › Onecta app (optional): control your indoor from any location with an app, via your local network or internet and keep an overview on your energy consumption
- › Seasonal efficiency values: full range A+++ in cooling and heating
- › Whisper quiet in operation: the operating of the unit can hardly be heard. The sound pressure level goes down to 19dBA!
- › 3-D air flow combines vertical and horizontal auto swing to circulate a stream of warm or cool air right to the corners of even large spaces
- › Reddot design award winner 2013



More details and final information can be found by scanning or clicking the QR codes.



FTXZ-N



RXZ-N

Efficiency data		FTXZ + RXZ		25N + 25N	35N + 35N	50N + 50N
Cooling capacity	Min./Nom./Max.	kW		0.6/2.5/3.9	0.6/3.5/5.3	0.6/5.0/5.8
Heating capacity	Min./Nom./Max.	kW		0.6/3.6/7.5	0.6/5.0/9.0	0.6/6.3/9.4
Power input	Cooling	Min./Nom./Max.	kW	0.11/0.41/0.88	0.11/0.66/1.33	0.11/1.10/1.60
	Heating	Min./Nom./Max.	kW	0.10/0.62/2.01	0.10/1.00/2.53	0.10/1.41/2.64
Space cooling	Energy efficiency class			A+++		
	Capacity	Pdesign	kW	2.50	3.50	5.00
	SEER			9.54	9.00	8.60
	Annual energy consumption		kWh/a	92	136	203
Space heating (Average climate)	Energy efficiency class			A+++		
	Capacity	Pdesign	kW	3.50	4.50	5.60
	SCOP/A			5.90	5.73	5.50
	Annual energy consumption		kWh/a	831	1,100	1,427
Nominal efficiency	EER			6.10	5.30	4.55
	COP			5.80	5.00	4.47
	Annual energy consumption		kWh	205	330	550
	Energy labeling Directive	Cooling/Heating		A/A		

Indoor unit		FTXZ		25N	35N	50N	
Dimensions	Unit	HeightxWidthxDepth		295x798x372			
Weight	Unit	kg		15			
Air filter	Type	Auto cleaning filter					
Fan	Air flow rate	Cooling	Silent operation/Low/High	m ³ /min	4.0/5.3/10.7	4.0/5.6/12.1	4.6/6.6/15.0
		Heating	Silent operation/Low/High	m ³ /min	4.8/6.7/11.7	4.8/6.9/13.3	5.9/7.7/14.4
Sound power level	Cooling	dBA		54	57	60	
	Heating	dBA		56	57	59	
Sound pressure level	Cooling	Silent operation/Low/Nom./High	dBA	19/26/33/38	19/27/35/42	23/30/38/47	
	Heating	Silent operation/Low/Nom./High	dBA	19/28/35/39	19/29/36/42	24/31/38/44	
Control systems	Infrared remote control		ARC477A1				
Power supply	Phase/Frequency/Voltage		Hz/V				
				1~/50/220-240			

Outdoor unit		RXZ		25N	35N	50N
Dimensions	Unit	HeightxWidthxDepth		693x795x300		
Weight	Unit	kg		50		
Sound power level	Cooling	dBA		59	61	63
	Heating	dBA		59	61	64
Sound pressure level	Cooling	High	dBA	46	48	49
	Heating	High	dBA	46	48	50
Operation range	Cooling	Ambient	Min.~Max.	°CDB		
	Heating	Ambient	Min.~Max.	°CWB		
Refrigerant	Type	R-32				
	GWP	675				
	Charge	kg/TCO ₂ Eq		1.34/0.9		
Piping connections	Liquid	OD	mm	6.35		
	Gas	OD	mm	9.5		
	Piping length	OU - IU	Max.	m		
	Level difference	IU - OU	Max.	m		
Power supply	Phase/Frequency/Voltage		Hz/V			
Current - 50Hz	Maximum fuse amps (MFA)		A			
				1~/50/220-240		
				16		

Wall mounted unit

Design that speaks for itself

- › Remarkable blend of iconic design and engineering excellence with an elegant finish in matt crystal white, silver and black
- › The Coanda effect optimises the airflow for a comfortable climate. By using specially designed flaps, a more focused airflow allows a better temperature distribution throughout the whole room
- › The intelligent thermal sensor determines the current room temperature and distributes air evenly throughout the room before switching to an airflow pattern that directs warm or cool air to areas that need it
- › Heat boost quickly heats up your home when starting up your air conditioner. Set temperature is reached 14% faster than a regular air conditioner (pair only)
- › Using electrons to trigger chemical reactions with air borne particles, the Flash Streamer breaks down allergens such as pollen and fungal allergens and removes bothersome odours providing a better, cleaner air
- › Voice command via Amazon Alexa or Google Assistant to control main functions such as set point, operation mode, fan speed, etc.
- › Onecta app: control your indoor from any location with an app, via your local network or internet
- › Whisper quiet in operation: the operating of the unit can hardly be heard. The sound pressure level goes down to 19dB(A)



- › Choosing for an R-32 product, reduces the environmental impact with 68% compared to R-410A and leads directly to lower energy consumption thanks to its high energy efficiency
- › Seasonal efficiency values up to A+++ in cooling and heating

More details and final information can be found by scanning or clicking the QR codes.



FTXJ-AW



FTXJ-AS



FTXJ-AB



RXJ-A

Efficiency data		FTXJ/RXJ	20AW/S/B + 20A	25AW/S/B + 25A	35AW/S/B + 35A	42AW/S/B + 42A	50AW/S/B + 50A
Cooling capacity	Min./Nom./Max.	kW	1.3/2.0/2.6	1.3/2.5/3.2	1.4/3.4/4.0	1.7/4.2/5.0	1.7/5.0/5.3
Heating capacity	Min./Nom./Max.	kW	1.3/2.5/3.5	1.3/2.8/4.7	1.4/4.0/5.2	1.7/5.4/6.0	1.7/5.8/6.5
Power input	Cooling	Nom. kW	-	-	-	-	-
	Heating	Nom. kW	-	-	-	-	-
Space cooling	Energy efficiency class		A+++		A++		
	Capacity	Pdesign kW	2	2,5	3,4	4,2	5
	SEER		8,75	8,74	8,73	7,5	7,33
	Annual energy consumption	kWh/a	80	100	136	196	239
Space heating (Average climate)	Energy efficiency class		A+++		A++		
	Capacity	Pdesign kW	2,4	2,45	2,5	3,8	4
	SCOP		5,15	5,15	5,15	4,6	4,6
	Annual energy consumption	kWh/a	653	666	680	1150	1217
Nominal efficiency	EER		4,7	4,46	4,37	3,99	3,68
	COP		5	5	4,04	4,12	4
	Annual energy consumption		-	-	-	-	-
	Energy labeling Directive - Cooling/Heating		A/A				

Indoor unit		FTXJ	20AW/S/B	25AW/S/B	35AW/S/B	42AW/S/B	50AW/S/B	
Dimensions	Unit HeightxWidthxDepth	mm	305x900x214					
Weight	Unit	kg	12					
Air filter	Type		-	-	-	-	-	
Fan	Air flow rate	Cooling	m³/min		-	-	-	
		Heating	m³/min		-	-	-	
Sound power level	Cooling	dBA	57	57	60	60	60	
	Heating	dBA	-	-	-	-	-	
Sound pressure level	Cooling	Silent operation/Low/High dBA	39/32/25/19*	40/33/25/19*	41/33/25/19*	45/37/29/21*	46/39/31/24*	
	Heating	Silent operation/Low/High dBA	39/32/25/19*	40/33/25/19*	41/33/25/19*	45/37/29/21*	46/42/33/24*	
Control systems	Infrared remote control		ARC488A1W/S/K					

* +2 dBA in Multi combination

Outdoor unit		RXJ	20A	25A	35A	42A	50A	
Dimensions	Unit HeightxWidthxDepth	mm	552.7x840x350		734x954x408			
Weight	Unit	kg	32		50			
Sound power level	Cooling	Nom. dBA	59	59	61	62	62	
	Heating	Nom. dBA	59	59	61	62	62	
Sound pressure level	Cooling	Nom. dBA	46	46	49	48	48	
	Heating	Nom. dBA	47	47	49	48	49	
Operation range	Cooling	Ambient Min.~Max. °CDB	-10~+50					
	Heating	Ambient Min.~Max. °CWB	-20~+24					
Refrigerant	Type/GWP		R-32/675.0					
	Charge	kg/TCO2Eq	0.76/0.52		1.10/0.75			
Piping connections	Liquid/Gas	OD mm	6.35/9.50		6.35/12.7			
	Piping length	OU - IU Max. m	20		30			
	Additional refrigerant charge	kg/m	0.02 (for piping length exceeding 10m)					
	Level difference	IU - OU Max. m	15		20			
Power supply	Phase/Frequency/Voltage	Hz/V	1~/50 /220-240					
Current - 50Hz	Maximum fuse amps (MFA)	A	10		13			

Contains fluorinated greenhouse gases

*Note: blue cells contain preliminary data

Wall mounted unit

Where innovation meets creativity

- > A compact and functional design suitable for all interiors in a white, black, silver and blackwood coloured elegant finish
- > The Coanda effect optimises the airflow for a comfortable climate. By using specially designed flaps, a more focused airflow allows a better temperature distribution throughout the whole room
- > The intelligent thermal sensor determines the current room temperature and distributes air evenly throughout the room before switching to an airflow pattern that directs warm or cool air to areas that need it
- > Practically inaudible: the unit runs so quietly, you will almost forget it is there.
- > Using electrons to trigger chemical reactions with air borne particles, the Flash Streamer breaks down allergens such as pollen and fungal allergens and removes bothersome odours providing a better, cleaner air
- > Onecta app: control your indoor from any location with an app, via your local network or internet.
- > Voice command via Amazon Alexa or Google Assistant to control main functions such as set point, operation mode, fan speed, etc
- > Choosing for an R-32 product, reduces the environmental impact with 68% compared to R-410A and leads directly to lower energy consumption thanks to its high energy efficiency



> Seasonal efficiency values up to A+++ in cooling and heating

More details and final information can be found by scanning or clicking the QR codes.



Efficiency data		FTXA + RXA	CTXA15AW/BS/BT/BB	20AW/BS/BT/BB + 20A9	25AW/BS/BT/BB + 25A9	35AW/BS/BT/BB + 35A9	42AW/BS/BT/BB + 42B	50AW/BS/BT/BB + 50B
Cooling capacity	Min./Nom./Max.	kW		1.30/2.00/2.60	1.30/2.50/3.20	1.40/3.40/4.00	1.70/4.20/5.00	1.70/5.00/5.30
Heating capacity	Min./Nom./Max.	kW		1.30/2.50/3.50	1.30/2.80/4.70	1.40/4.00/5.20	1.70/5.40/6.00	1.70/5.80/6.50
Power input	Cooling	Min./Nom./Max.	kW	0.27/0.43/0.63	0.27/0.56/0.78	0.31/0.78/1.04	-/1.05/-	-/1.36/-
	Heating	Min./Nom./Max.	kW	0.25/0.50/0.91	0.25/0.56/1.22	0.26/0.99/1.67	-/1.31/-	-/1.45/-
Space cooling	Energy efficiency class				A+++		A++	
	Capacity	Pdesign	kW	2.00	2.50	3.40	4.20	5.00
	SEER			8.75	8.74	8.73	7.50	7.33
	Annual energy consumption		kWh/a	80	100	136	196	239
Space heating (Average climate)	Energy efficiency class				A+++		A++	
	Capacity	Pdesign	kW	2.40	2.45	2.50	3.80	4.00
	SCOP/A				5.15		4.60	
	Annual energy consumption		kWh/a	653	666	680	1,150	1,217
Nominal efficiency	EER			4.70	4.46	4.37	3.99	3.68
	COP				5.00	4.04	4.12	4.00
	Annual energy consumption				-		526	679
Energy labeling Directive		Cooling/Heating		A/A				

Indoor unit			FTXA	CTXA15AW/BS/BT/BB	20AW/BS/BT/BB	25AW/BS/BT/BB	35AW/BS/BT/BB	42AW/BS/BT/BB	50AW/BS/BT/BB	
Dimensions	Unit	HeightxWidthxDepth	mm						295x798x189	
Weight	Unit		kg						11.5	
Air filter	Type								Removable / washable	
Fan	Air flow rate	Cooling	Silent operation/Low/Medium/High	m³/min	4.6/6.1/8.2/11.0	4.6/6.1/8.6/11.5	4.6/6.1/8.6/11.9	4.6/7.2/9.8/13.1	5.2/7.6/10.4/13.5	
		Heating	Silent operation/Low/Medium/High	m³/min	4.5/6.4/8.7/10.9	4.5/6.4/9.0/11.1	4.5/6.4/9.0/11.5	5.2/7.7/10.5/14.6	5.7/8.2/11.1/15.1	
Sound power level	Cooling			dBA	57			60		
Sound pressure level	Cooling	Silent operation/Low/High		dBA	21/25/39	19/25/39	19/25/40	19/25/41	21/29/45	
	Heating	Silent operation/Low/High		dBA	21/25/39	19/25/39	19/25/40	19/25/41	21/29/45	
Control systems	Infrared remote control		ARC466A58							

Outdoor unit			RXA	20A9	25A9	35A9	42B	50B	
Dimensions	Unit	HeightxWidthxDepth	mm		550x840x350		734x870x373		
Weight	Unit		kg		32		50		
Sound power level	Cooling	Nom.	dBA		59.0		61.0		
	Heating	Nom.	dBA		59.0		61.0		
Sound pressure level	Cooling	Nom.	dBA		46.0		49.0		
	Heating	Nom.	dBA		47.0		49.0		
Operation range	Cooling	Ambient	Min.-Max.	°CDB		-10~46		-15~18	
	Heating	Ambient	Min. - Max.	°CDB		-15-24		-15~18	
Refrigerant	Type/GWP			R-32/675.0					
Piping connections	Charge	kg/CO2Eq		0.76/0.52		1.10/0.75			
	Liquid/Gas	OD	mm	6.35/9.50		6.35/12.7			
Power supply	Piping length	OU - IU	Max.	m		20		30	
	Additional refrigerant charge	kg/m		0.02 (for piping length exceeding 10m)					
Current - 50Hz	Level difference	IU - OU	Max.	m		15.0		20	
	Phase/Frequency/Voltage	Hz/V		1~/50 /220-240					
Maximum fuse amps (MFA)			A		10		13		

Contains fluorinated greenhouse gases | See separate drawing for operation range | See separate drawing for electrical data | Nominal cooling capacities are based on: indoor temperature: 27°CDB, 19°CWB, outdoor temperature: 35°CDB, equivalent refrigerant piping: 5m, level difference: 0m. | Nominal heating capacities are based on: indoor temperature: 20°CDB, outdoor temperature: 7°CDB, 6°CWB, equivalent refrigerant piping: 5m, level difference: 0m.

Wall mounted unit

Attractive, wall mounted design with perfect indoor air quality

- › Seasonal efficiency values up to A+++ in cooling and heating
- › Heat boost quickly heats up your home when starting up your air conditioner. Set temperature is reached 14% faster than a regular air conditioner (pair only)
- › Using electrons to trigger chemical reactions with air borne particles, the Flash Streamer breaks down allergens such as pollen and fungal allergens and removes bothersome odours providing a better, cleaner air
- › Silver allergen removal and air purifying filter captures allergens such as pollen to ensure a steady supply of clean air
- › Voice command via Amazon Alexa or Google Assistant to control main functions such as set point, operation mode, fan speed, etc
- › Onecta app: control your indoor from any location with an app, via your local network or internet.
- › Quiet operation: down to 19dBa sound pressure level
- › 3-D air flow combines vertical and horizontal auto swing to circulate a stream of warm or cool air right to the corners of even large spaces
- › 2-area motion detection sensor: air flow is sent to a zone other than where the person is located at that moment; if no people are detected, the unit will automatically switch over to the energy-efficient setting. (larger capacity area)



More details and final information can be found by scanning or clicking the QR codes.



CTXM-R



FTXM-R



RXM-R



RXM-R9



Efficiency data			FTXM + RXM	CTXM15R	20R + 20R9	25R + 25R9	35R + 35R9	42R + 42R	50R + 50R	60R + 60R	71R + 71R
Cooling capacity	Min./Nom./Max.		kW	Multi combination only	1.30/2.00/2.60	1.30/2.50/3.20	1.40/3.40/4.00	1.70/4.20/5.00	1.70/5.00/6.00	1.70/6.00/7.00	2.30/7.10/8.50
Heating capacity	Min./Nom./Max.		kW		1.30/2.50/3.50	1.30/2.80/4.70	1.40/4.00/5.20	1.70/5.40/6.00	1.70/5.80/7.70	1.70/7.00/8.00	2.30/8.20/10.20
Power input	Cooling	Nom.	kW		0.44	0.56	0.80	0.97	1.36	1.77	2.34
	Heating	Nom.	kW		0.50	0.56	0.99	1.31	1.45	1.94	2.57
Space cooling	Energy efficiency class					A+++				A+	
	Capacity	Pdesign	kW		2.00	2.50	3.40	4.20	5.00	6.00	7.10
	SEER					8.65		7.85	7.41	6.90	6.20
Space heating (Average climate)	Annual energy consumption		kWh/a		81	101	137	187	236	304	401
	Energy efficiency class					A+++			A+		A+
	Capacity	Pdesign	kW		2.30	2.40	2.50	4.00	4.60	4.80	6.20
Nominal efficiency	SCOP/A					5.10		4.71		4.30	4.10
	Annual energy consumption		kWh/a		631	659	686	1,189	1,368	1,562	2,117
	EER			4.57	4.50	4.23	4.33	3.68	3.39	3.03	
Annual energy consumption	COP				5.00	4.04	4.12	4.00	3.61	3.19	
	Annual energy consumption		kWh	219	278	402	485	679	885	1,172	
	Energy labeling Directive		Cooling/Heating				A/A			B/D	

Indoor unit			FTXM	CTXM15R	20R	25R	35R	42R	50R	60R	71R	
Dimensions	Unit	HeightxWidthxDepth	mm	295x778x272						299x998x292		
Weight	Unit		kg	10.0						14.5		
Air filter	Type			Removable/washable								
Fan	Air flow rate	Cooling	Silent operation/Low/Medium/High	m ³ /min	4.3/5.7/7.5/10.5	4.1/5.7/7.6/10.5	4.2/6.0/7.8/11.3	4.3/6.5/9.0/11.9	8.3/11.4/14/15.8	9.1/11.8/14/16.7	10.0/12.2/15/16.9	
		Heating	Silent operation/Low/Medium/High	m ³ /min	5.1/6.2/8.2/9.3	4.9/6.3/8.0/9.8	4.9/6.5/8.5/9.8	4.9/6.5/9.7/12.4	10.5/12.0/14.2/15.8	11.1/12.4/15.2/16.5	11.6/12.7/15.8/17.7	
Sound power level	Cooling		dBa	57			58	60	58.0	60.0		
	Heating		dBa	54			60	58.0	59.0	61.0		
Sound pressure level	Cooling	Silent operation/Low/High	dBa	19/25/41			19/29/45	21/30/45	27.0/36.0/44.0	30.0/37.0/46.0	32.0/38.0/47.0	
	Heating	Silent operation/Low/High	dBa	20/26/39			20/27/39	20/28/39	21/29/45	31.0/34.0/43.0	33.0/36.0/45.0	
Control systems	Infrared remote control			ARC466A67								

Outdoor unit			RXM	CTXM15R	20R9	25R9	35R9	42R	50R	60R	71R	
Dimensions	Unit	HeightxWidthxDepth	mm	Multi combination only	552x840x350			734x954x401				
Weight	Unit		kg		32			49.0				
Sound power level	Cooling	Nom.	dBa		59.0	58.0	61.0	-				
	Heating	Nom.	dBa		59.0	61.0	-					
Sound pressure level	Cooling	Nom.	dBa		46.0	49.0	47.0					
	Heating	Nom.	dBa		47.0	49.0	48.0	49.0	48.0			
Operation range	Cooling	Ambient	Min.-Max.		-10~50			-10~50				-10~46
	Heating	Ambient	Min. - Max.		-20~24			-20~24				-15~24
Refrigerant	Type/GWP				R-32/675.0							
Piping connections	Charge		kg/CO2Eq		0.76/0.52			1.10/0.750		1.15/0.780		
	Liquid	OD	mm		6.35			6		15.9		
Piping connections	Gas	OD	mm		9.50			12.7		15.9		
	Piping length	OU - IU	Max.	20			30		30			
Additional refrigerant charge	System	Chargeless	m	10								
	Level difference	IU - OU	Max.	0.02 (for piping length exceeding 10m)								
Power supply	Phase/Frequency/Voltage		Hz/V	15								
	Current - 50Hz	Maximum fuse amps (MFA)	A	10			13			16		20

See separate drawing for operation range | See separate drawing for electrical data | Nominal cooling capacities are based on: indoor temperature: 27°CDB, 19°CWB, outdoor temperature: 35°CDB, equivalent refrigerant piping: 5m, level difference: 0m. | Nominal heating capacities are based on: indoor temperature: 20°CDB, outdoor temperature: 7°CDB, 6°CWB, equivalent refrigerant piping: 5m, level difference: 0m. | Cooling: indoor temp. 27°CDB, 19.0°CWB; outdoor temp. 35°CDB, 24°CWB; equivalent piping length: 5m | Heating: indoor temp. 20°CDB; outdoor temp. 7°CDB, 6°CWB; equivalent refrigerant piping: 5m | Contains fluorinated greenhouse gases | See separate drawings for electrical data

Wall mounted unit

Discreet wall mounted unit providing high efficiency and comfort

- › Practically inaudible: the unit runs so quietly, you will almost forget it is there.
- › Onecta app (optional): control your indoor from any location with an app, via your local network or internet.
- › Voice command via Amazon Alexa or Google Assistant to control main functions such as set point, operation mode, fan speed, etc
- › Silver allergen removal and air purifying filter captures allergens such as pollen to ensure a steady supply of clean air
- › 3-D air flow combines vertical and horizontal auto swing to circulate a stream of warm or cool air right to the corners of even large spaces
- › The unit's compact dimensions makes it ideal for renovation projects, especially for above door installation
- › Choosing for an R-32 product, reduces the environmental impact with 68% compared to R-410A and leads directly to lower energy consumption thanks to its high energy efficiency
- › Seasonal efficiency values up to A++ in cooling and heating
- › Space saving contemporary wall mounted design



- › Up to 3 indoor units can be connected to 1 multi outdoor unit; all indoor units are individually controllable and do not need to be installed in the same room or at the same time. They operate simultaneously within the same heating or cooling mode.

More details and final information can be found by scanning or clicking the QR codes.



FTXP-M



FTXP-M9



RXP-M

Efficiency data				FTXP + RXP	20M9 + 20M	25M9 + 25M	35M9 + 35M	50M + 50M	60M + 60M	71M + 71M
Cooling capacity	Min./Nom./Max.			kW	1.3/2.00/2.6	1.3/2.50/3.0	1.3/3.50/4.0	1.7/5.0/6.0	1.7/6.0/7.0	2.3/7.1/7.3
Heating capacity	Min./Nom./Max.			kW	1.30/2.50/3.50	1.30/3.00/4.00	1.30/4.00/4.80	1.7/6.0/7.7	1.7/7.0/8.0	2.3/8.2/9.0
Power input	Cooling	Min./Nom./Max.		kW	0.31/0.50/0.72	0.31/0.65/0.72	0.29/1.01/1.30	0.320/1.385/1.826	0.332/1.824/2.980	0.449/2.689/3.274
	Heating	Min./Nom./Max.		kW	0.25/0.52/0.95	0.25/0.69/0.95	0.29/1.00/1.29	0.440/1.579/2.356	0.456/1.928/2.787	0.617/2.571/3.306
Space cooling	Energy efficiency class							A++		
	Capacity	Pdesign		kW	2.00	2.50	3.50	5.0	6.0	7.1
	SEER				6.79	6.92	6.62	7.30	6.82	6.20
	Annual energy consumption			kWh/a	103	126	186	240	308	401
Space heating (Average climate)	Energy efficiency class					A++			A+	
	Capacity	Pdesign		kW	2.20	2.40	2.80	4.60	4.80	6.20
	SCOP/A				4.65	4.61	4.64	4.40	4.10	4.01
	Annual energy consumption			kWh/a	662	728	845	1,463	1,638	2,166
Nominal efficiency	EER				4.02	3.83	3.49	3.61	3.29	2.64
	COP				4.77	4.36	4.02	3.80	3.63	3.19
	Annual energy consumption			kWh	249	326	505	693	912	1,345
	Energy labeling Directive	Cooling/Heating				A/A			-/-	

Indoor unit				FTXP	20M9	25M9	35M9	50M	60M	71M	
Dimensions	Unit	HeightxWidthxDepth		mm	286x770x225			295x990x263			
Weight	Unit			kg	8.50			9.00			
Air filter	Type				Removable / washable						
Fan	Air flow rate	Cooling	Silent operation/Low/Medium/High	m³/min	4.2/5.6/7.4/9.5	4.2/5.8/7.7/9.7	4.5/6.3/8.3/11.5	8.3/11.5/14.0/16.3	9.2/11.8/14.4/16.8	10.1/11.8/14.4/16.8	
		Heating	Silent operation/Low/Medium/High	m³/min	5.2/6.2/8.1/10.4	5.2/6.4/8.1/10.4	5.3/7.0/9.0/11.5	10.4/11.8/14.4/17.3	11.0/12.4/15.3/17.9		
Sound power level	Cooling			dBA	55			58	59	60	62
	Heating			dBA	55			58	61	62	
Sound pressure level	Cooling	Silent operation/Low/High		dBA	19/25/39	19/26/40	20/27/43	27/34/43	30/36/45	32/37/46	
	Heating	Silent operation/Low/High		dBA	21/28/39	21/28/40	21/29/40	30/38/42	32/40/44	33/41/45	
Control systems	Infrared remote control				ARC480A53						

Outdoor unit				RXP	20M	25M	35M	50M	60M	71M
Dimensions	Unit	HeightxWidthxDepth		mm	550x658x275			734x870x373		
Weight	Unit			kg	26		28	46.0	50.0	
Sound power level	Cooling			dBA	60		62	61	63	66
Sound pressure level	Cooling	Nom.		dBA	46		48	47	49	52
	Heating	Nom.		dBA	47		48			52
Operation range	Cooling	Ambient	Min.-Max.	°CDB				-10~48		
	Heating	Ambient	Min.-Max.	°CWB				-20~18		
Refrigerant	Type				R-32					
	GWP				675.0					
Piping connections	Charge			kg/CO2Eq	0.55/0.37		0.70/0.48	0.90/0.61	1.15/0.78	
	Liquid	OD		mm	6.4			6.35		
	Gas	OD		mm	9.5			12.7		
	Piping length	OU - IU	Max.	m	20			30		
Additional refrigerant charge	Level difference	IU - OU	Max.	kg/m	0.02 (for piping length exceeding 10m)					
				m	12			20		
Power supply	Phase/Frequency/Voltage			Hz/V	1~/50 /220-240					
Current - 50Hz	Maximum fuse amps (MFA)			A	16			20		

Nominal cooling capacities are based on: indoor temperature: 27°CDB, 19°CWB, outdoor temperature: 35°CDB, equivalent refrigerant piping: 5m, level difference: 0m. | Nominal heating capacities are based on: indoor temperature: 20°CDB, outdoor temperature: 7°CDB, 6°CWB, equivalent refrigerant piping: 5m, level difference: 0m. | See separate drawing for electrical data | See separate drawing for operation range | Contains fluorinated greenhouse gases

Wall mounted unit

Wall mounted unit for low energy consumption and pleasant comfort

- > Seasonal efficiency values up to A++ in cooling
- > Onecta app (optional): control your indoor from any location with an app, via your local network or internet.
- > Voice command via Amazon Alexa or Google Assistant to control main functions such as set point, operation mode, fan speed, etc
- > Quiet in operation down to 21 dBA
- > Choosing for an R-32 product, reduces the environmental impact with 68% compared to R-410A and leads directly to lower energy consumption thanks to its high energy efficiency



More details and final information can be found by scanning or clicking the QR codes.



FTXF-D



RXF-D

Efficiency data		FTXF + RXF	20D + 20D	25D + 25D	35D + 35D	42D + 42D	50D + 50D	60D + 60D	71D + 71D	
Cooling capacity	Min./Nom./Max.	kW	1.3/2.00/2.4	1.3/2.50/2.8	1.3/3.30/3.8	1.4/4.20/4.3	1.70/5.00/6.00	1.70/6.00/7.00	2.30/7.10/7.30	
Heating capacity	Min./Nom./Max.	kW	1.30/2.40/3.30	1.30/2.80/3.70	1.30/3.50/4.40	1.40/4.60/5.00	1.70/6.00/7.70	1.70/6.40/8.00	2.30/8.20/9.00	
Power input	Cooling	Min./Nom./Max.	kW	0.31/0.592/0.72	0.31/0.772/1.05	0.31/1.00/1.40	0.31/1.27/1.50	-1.50/-	-1.85/-	-2.77/-
	Heating	Min./Nom./Max.	kW	0.25/0.640/0.95	0.25/0.750/1.11	0.25/0.940/1.50	0.25/1.24/1.40	-1.62/-	-1.63/-	-2.60/-
Space cooling	Energy efficiency class					A++			A	
	Capacity	Pdesign	kW	2.00	2.50	3.50	4.20	5.00	6.00	7.10
	SEER			6.5		6.50	6.21	6.15	5.15	
	Annual energy consumption		kWh/a	113	141	197	226	282	342	483
Space heating (Average climate)	Energy efficiency class					A+			A	
	Capacity	Pdesign	kW	2.20	2.40	2.60	3.30	4.60	4.80	6.20
	SCOP/A			4.11		4.30		4.06		3.81
	Annual energy consumption		kWh/a	749	817	885	1,075	1,585	1,653	2,278
Nominal efficiency	EER		3.38	3.24	3.30		3.33	3.25	2.56	
	COP		3.75	3.73	3.72	3.71		3.93	3.15	
	Annual energy consumption		kWh				751	923	1,387	
Energy labeling Directive		Cooling/Heating	A/A							E/D

Indoor unit		FTXF	20D	25D	35D	42D	50D	60D	71D	
Dimensions	Unit	HeightxWidthxDepth	286x770x225				295x990x263			
Weight	Unit	kg	8.00		8.50	9.00	13.5			
Air filter	Type		Removable / washable							
Fan	Air flow rate	Cooling	Silent operation/Low/Medium/High	m³/min	3.6/4.6/6/8.3	3.6/4.6/6/8.5	4.4/6.4/8/11.8	4.9/6.9/9/12.6	10.5/11.9/14.4/16.8	10.7/12.2/14.8/17.3
		Heating	Silent operation/Low/Medium/High	m³/min	4.6/5.8/7.8/9.7	4.6/6.0/7.9/9.7	5.3/6.5/8.6/11.9	5.2/6.7/8.8/12.8	10.7/12.2/14.8/17.3	11.3/12.8/15.8/17.9
Sound power level	Cooling		53.0	54.0	59.0	59	60	62		
	Heating		55.0	56.0	59.0	61	62			
Sound pressure level	Cooling	Silent operation/Low/High	dBA	20.0/25.0/39.0	20.0/26.0/40.0	20.0/27.0/43.0	22.0/30.0/45.0	31/34/43	33/36/45	34/37/46
	Heating	Silent operation/Low/High	dBA	21.0/28.0/39.0	21.0/28.0/40.0	21.0/29.0/40.0	22.0/28.0/44.0	30/33/42	32/35/44	33/36/45
Control systems	Infrared remote control		ARC470A1							

Outdoor unit		RXF	20D	25D	35D	42D	50D	60D	71D	
Dimensions	Unit	HeightxWidthxDepth	550x658x275				734x870x373			
Weight	Unit	kg	25.5		26.0	28.0	46.0	50.0		
Sound power level	Cooling		-							
Sound pressure level	Cooling	Nom./High	dBA	-46.0		-48.0		47/-	49/-	52/-
	Heating	Nom./High	dBA	-47.0		-48.0		49/-		52/-
Operation range	Cooling	Ambient	Min.-Max.	-10~48						
	Heating	Ambient	Min.-Max.	-15~18						
Refrigerant	Type		R-32							
	GWP		675.0							
Piping connections	Charge	kg/CO2Eq	0.450/0.300	0.550/0.370	0.750/0.510	0.90/0.61	1.15/0.78			
	Liquid	OD	mm	6.35						
Piping connections	Gas	OD	mm	9.50			12.7			
	Piping length	OU - IU	Max.	20			30			
	Additional refrigerant charge	kg/m	0.02 (for piping length exceeding 10m)							
	Level difference	IU - OU	Max.	12.0			20			
Power supply	Phase/Frequency/Voltage	Hz/V	1~/50 /220-240							
Current - 50Hz	Maximum fuse amps (MFA)	A	16			20				

Nominal cooling capacities are based on: indoor temperature: 27°CDB, 19°CWB, outdoor temperature: 35°CDB, equivalent refrigerant piping: 5m, level difference: 0m. Data for high efficiency series, Eurovent certified | Nominal heating capacities are based on: indoor temperature: 20°CDB, outdoor temperature: 7°CDB, 6°CWB, equivalent refrigerant piping: 5m, level difference: 0m. Data for standard efficiency series | See separate drawing for electrical data | Nominal cooling capacities are based on: indoor temperature: 27°CDB, 19°CWB, outdoor temperature: 35°CDB, equivalent refrigerant piping: 5m, level difference: 0m. | Nominal heating capacities are based on: indoor temperature: 20°CDB, outdoor temperature: 7°CDB, 6°CWB, equivalent refrigerant piping: 5m, level difference: 0m. | See separate drawing for operation range | Contains fluorinated greenhouse gases

*Note: blue cells contain preliminary data

Wall mounted unit

Wall mounted unit, offering good value for money

- › Flat, stylish front panel blends easily within any interior décor and is easier to clean
- › Onecta app (optional): control your indoor from any location with an app, via your local network or internet.
- › Seasonal efficiency values up to A++ in cooling
- › Choosing for an R-32 product, reduces the environmental impact with 68% compared to R-410A and leads directly to lower energy consumption thanks to its high energy efficiency



More details and final information can be found by scanning or clicking the QR codes.



FTXC-C



RXC-C

Efficiency data		FTXC + RXC		20C + 20C		25C + 25C		35C + 35C		50C + 50C		60C + 60C		71C + 71C		
Cooling capacity	Min./Max.	kW		1.3/3.0		1.3/4.0		1.3/4.0		1.4/6.2		1.8/7.0		2.3/7.3		
Heating capacity	Min./Max.	kW		1.30/4.00		1.30/4.80		1.36/6.60		1.48/8.00		2.30/9.00				
Space cooling	Energy efficiency class						A ⁺⁺						A			
	Capacity	Pdesign	kW		2.08		2.57		3.44		5.08		6.21		6.96	
	SEER		kW		6.89		6.84		6.87		6.45		6.40		5.30	
	Annual energy consumption		kWh/a		106		132		175		276		340		459	
Space heating (Average climate)	Energy efficiency class						A ⁺								A	
	Capacity	Pdesign	kW		1.87		2.23		2.24		3.90		4.10		6.35	
	SCOP/A		kW		4.40		4.45		4.28		4.42		4.24		3.81	
	Annual energy consumption		kWh/a		594		700		732		1,236		1,354		2,334	
Indoor unit		FTXC		20C		25C		35C		50C		60C		71C		
Dimensions	Unit	HeightxWidthxDepth		mm		288x770x234		288x770x234		288x770x234		297x990x273		297x990x273		
Weight	Unit	kg		9.00		9.00		9.50		9.50		13.0		13.0		
Air filter	Type	Removable / washable														
Fan	Air flow rate	Cooling	Silent operation/Low/Medium/High	m ³ /min		5.4/6.5/9/10.8		5.4/6.5/9/10.8		7.4/8.2/10/12.2		10.2/13.6/16/20.4		10.2/13.6/16/20.4		
Sound power level	Cooling	dBA		54		54		55		57		60		60		
Sound pressure level	Cooling	dBA		20/26/38		20/26/38		21/26/39		29/33/45		30/38/46		30/38/46		
Control systems	Infrared remote control	ARC486A2														
Outdoor unit		RXC		20C		25C		35C		50C		60C		71C		
Dimensions	Unit	HeightxWidthxDepth		mm		550x658x273		550x658x273		550x658x273		615x845x300		695x930x350		
Weight	Unit	kg		24.0		24.0		26.0		26.0		39.0		45.0		
Sound power level	Cooling	dBA		58		58		60		65		66		69		
Sound pressure level	Cooling	dBA		45		45		46		51		54		54		
Operation range	Cooling	Ambient	Min.--Max.	°CDB		10~46		10~46		10~46		-10~46		-10~46		
	Heating	Ambient	Min.--Max.	°CWB						-15~18						
Refrigerant	Type	R-32														
	GWP	675.0														
Charge		kg/TCO ₂ Eq		0.550/0.371		0.550/0.371		0.750/0.506		1.00/0.675		1.10/0.743		1.15/0.776		
Piping connections	Liquid	mm		6.35		6.35		6.35		6.35		6.35		6.35		
	Gas	mm		9.52		9.52		9.52		9.52		12.7		12.7		
Piping length	OU - IU	m		20		20		20		20		30		30		
Additional refrigerant charge	IU - OU Max. difference	kg/m		8		8		8		8		8		8		
Level difference	IU - OU Max. difference	m		15.0		15.0		15.0		15.0		20.0		20.0		
Power supply	Phase/Frequency/Voltage	Hz/V		1~/50 /220-240		1~/50 /220-240		1~/50 /220-240		1~/50 /220-240		1~/50 /220-240		1~/50 /220-240		
Current - 50Hz	Maximum fuse amps (MFA)	A		16		16		16		16		16		16		

Wall mounted unit

Wall mounted unit, offering good value for money

- › Flat, stylish front panel blends easily within any interior décor and is easier to clean
- › Onecta app (optional): control your indoor from any location with an app, via your local network or internet.
- › Seasonal efficiency values up to A++ in cooling
- › Choosing for an R-32 product, reduces the environmental impact with 68% compared to R-410A and leads directly to lower energy consumption thanks to its high energy efficiency



More details and final information can be found by scanning or clicking the QR codes.



FTXQ-A



RXQ-A

Efficiency data		FTXQ + RXQ		25A + 25A		35A + 35A	
Cooling capacity	Min./Nom./Max.	kW		1.30/2.50/3.00		1.30/3.50/3.80	
Heating capacity	Min./Nom./Max.	kW		1.30/3.00/3.90		1.30/3.90/4.80	
Power input	Cooling	Nom.	kW	0.77		1.08	
	Heating	Nom.	kW	0.81		1.05	
Space cooling	Energy efficiency class			A++			
	Capacity	Pdesign	kW	2.50		3.50	
	SEER			6.22		6.21	
	Annual energy consumption		kWh/a	141		197	
Space heating (Average climate)	Energy efficiency class			A+			
	Capacity	Pdesign	kW	2.30		2.40	
	SCOP/A			4.22		4.12	
	Annual energy consumption		kWh/a	764		815	
Nominal efficiency	EER			3.24			
	COP			3.71			
	Annual energy consumption		kWh	386		540	
	Energy labeling	Cooling/Heating Directive		A/A			

Indoor unit		FTXQ		25A		35A	
Dimensions	Unit	HeightxWidthxDepth		mm		291 x770 x232	
Weight	Unit	kg		9.00			
Air filter	Type	Removable / washable					
Fan	Air flow rate	Cooling	Silent operation/Low/Medium/High	m ³ /min		5.0/6.5/8.1/10.2	
		Heating	Silent operation/Low/Medium/High	m ³ /min		6.0/7.0/8.5/10.5	
Sound power level	Cooling	dBA		55			
Sound pressure level	Cooling	Silent operation/Low/High		dBA		23.0 /26.0 /40.0	
	Heating	Silent operation/Low/High		dBA		25.0 /29.0 /40.0	
Control systems	Infrared remote control		ARC470A1				

Outdoor unit		RXQ		25A		35A		
Dimensions	Unit	HeightxWidthxDepth		mm		550x740x337		
Weight	Unit	kg		23.0		25.5		
Sound power level	Cooling	Nom.		dBA		61.0		
Sound pressure level	Cooling	High		dBA		47.0		
Operation range	Cooling	Ambient	Min.–Max.	°CDB		10~46		
	Heating	Ambient	Min.–Max.	°CWB		-15~18		
Refrigerant	Type	R-32						
	GWP	675.0						
	Charge	kg/CO ₂ Eq		0.500/0.340		0.710/0.480		
Piping connections	Liquid	OD		mm		6.35		
	Gas	OD		mm		9.50		
	Piping length	OU - IU	Max.	m		20		
	Additional refrigerant charge		kg/m		0.02 (for piping length exceeding 10m)			
	Level difference	IU - OU	Max.	m		12.0		
Power supply	Phase/Frequency/Voltage		Hz/V		1~/50 /220-240			
Current - 50Hz	Maximum fuse amps (MFA)		A		16			

Cooling: indoor temp. 27°CDB, 19.0°CWB; outdoor temp. 35°CDB, 24°CWB; equivalent piping length: 5m | Heating: indoor temp. 20°CDB; outdoor temp. 7°CDB, 6°CWB; equivalent refrigerant piping: 5m | Contains fluorinated greenhouse gases | See separate drawing for operation range | See separate drawings for electrical data

Floor standing unit

Design floor standing unit for optimal heating comfort thanks to unique heating features

- › Seasonal efficiency values up to A++ in heating, resulting in low running costs compared to gas boilers and electric heating
- › Excellent contemporary design
- › Heat boost quickly heats up your home when starting up your air conditioner. Set temperature is reached 14% faster than a regular air conditioner (pair only)
- › The floor warming function optimises convection by distributing hot air from the bottom of the unit
- › The heat plus function provides 30 minutes cosy heating by simulating radiant heat
- › Dual air discharge flow for better air distribution
- › Using electrons to trigger chemical reactions with air borne particles, the Flash Streamer breaks down allergens such as pollen and fungal allergens and removes bothersome odours providing a better, cleaner air
- › Onecta app: control your indoor from any location with an app, via your local network or internet.



- › Quiet operation: down to 19dBa sound pressure level
- › Combinable with 2 and 3 port multi outdoor units (except 2-3MXM68)

More details and final information can be found by scanning or clicking the QR codes.



CVXM-A



FVXM-A



RXM-R



RXM-R9



Efficiency data				FVXM + RXM	CVXM20A	25A + 25R9	35A + 35R9	50A + 50R
Cooling capacity	Min./Nom./Max.			kW		1.30/2.40/3.50	1.40/3.40/4.00	1.40/5.00/5.80
Heating capacity	Min./Nom./Max.			kW		1.30/3.40/4.70	1.40/4.50/5.80	1.40/5.80/8.10
Power input	Cooling	Nom.		kW		0.54	0.85	1.31
	Heating	Nom.		kW		0.75	1.15	1.52
Space cooling	Energy efficiency class					A++		A++
	Capacity	Pdesign		kW		2.40	3.40	5.00
	SEER					8.55	8.11	7.30
	Annual energy consumption			kWh/a		98	147	240
Space heating (Average climate)	Energy efficiency class						A++	A++
	Capacity	Pdesign		kW		2.30	2.80	4.10
	SCOP/A					4.65	4.63	4.31
	Annual energy consumption			kWh/a		693	847	1,330
Nominal efficiency	EER					4.47	4.01	3.81
	COP					4.55	3.90	3.81
	Annual energy consumption			kWh		268	424	656
	Energy labeling Directive	Cooling/Heating					A/A	

Indoor unit				FVXM	CVXM20A	25A	35A	50A
Dimensions	Unit	HeightxWidthxDepth		mm	600x750x238			
Weight	Unit			kg	17			
Air filter	Type				Removable / washable			
Fan	Air flow rate	Cooling	Silent operation/Low/Medium/High	m³/min	4.1/4.9/7/8.7		4.1/4.9/7/9.2	5.4/6.6/9/11.6
		Heating	Silent operation/Low/Medium/High	m³/min	4.1/5.6/7.2/9.2		4.1/5.6/7.2/9.8	5.9/8.4/10.0/12.8
Sound power level	Cooling			dBa	52.0		53.0	61.0
	Heating			dBa	52.0		53.0	62.0
Sound pressure level	Cooling	Silent operation/Low/High		dBa	22.0/25.0/38.0	20.0/25.0/38.0	20.0/25.0/39.0	27.0/31.0/44.0
	Heating	Silent operation/Low/High		dBa	21.0/25.0/38.0	19.0/25.0/38.0	19.0/25.0/39.0	29.0/35.0/46.0
Control systems	Infrared remote control				ARC466A66			

Outdoor unit				RXM	CVXM20A	25R9	35R9	50R
Dimensions	Unit	HeightxWidthxDepth		mm		552x840x350		734x954x401
Weight	Unit			kg		32		49.0
Sound power level	Cooling	Nom.		dBa		58.0	61.0	62.0
	Heating	Nom.		dBa		59.0	61.0	62.0
Sound pressure level	Cooling	Nom.		dBa		46.0	49.0	48.0
	Heating	Nom.		dBa		47.0		49.0
Operation range	Cooling	Ambient	Min.~Max.	°CDB			-10~46	
	Heating	Ambient	Min. - Max.	°CDB			-15~24	
Refrigerant	Type/GWP					R-32/675.0		
Piping connections	Charge			kg/TCO2Eq		0.76/0.52		1.15/0.780
	Liquid/Gas	OD		mm		6.35/9.50		6/12.7
	Piping length	OU - IU	Max.	m		20		30
	System	Chargeless		m		10		
Additional refrigerant charge	Level difference		IU - OU	Max.		0.02 (for piping length exceeding 10m)		
				m		15		20.0
Power supply	Phase/Frequency/Voltage			Hz/V		1~/50 /220-240		
Current - 50Hz	Maximum fuse amps (MFA)			A		13		16

Nominal heating capacities are based on: indoor temperature: 20°CDB, outdoor temperature: 7°CDB, 6°CWB, equivalent refrigerant piping: 5m, level difference: 0m. | See separate drawing for operation range | See separate drawing for electrical data | Cooling: indoor temp. 27°CDB, 19°CWB; outdoor temp. 35°CDB, 24°CWB; equivalent piping length: 5m | Heating: indoor temp. 20°CDB; outdoor temp. 7°CDB, 6°CWB; equivalent refrigerant piping: 5m | Contains fluorinated greenhouse gases | See separate drawings for electrical data

Floor standing unit

Floor standing unit for optimal heating comfort thanks to dual airflow

- › Its low height (620 mm) enables the unit to fit perfectly beneath a window
- › Onecta app (optional): control your indoor from any location with an app, via your local network or internet.
- › Voice command via Amazon Alexa or Google Assistant to control main functions such as set point, operation mode, fan speed, etc
- › Quiet operation: down to 23dBA sound pressure level
- › Choosing for an R-32 product, reduces the environmental impact with 68% compared to R-410A and leads directly to lower energy consumption thanks to its high energy efficiency



More details and final information can be found by scanning or clicking the QR codes.



FVXM-F



RXM-R



RXM-R9

Efficiency data		FVXM + RXM	25F + 25R9	35F + 35R9	50F + 50R
Cooling capacity	Min./Nom./Max.	kW	1.30/2.50/3.00	1.40/3.50/3.80	1.40/5.00/5.60
Heating capacity	Min./Nom./Max.	kW	1.30/3.40/4.50	1.40/4.50/5.00	1.40/5.80/8.10
Power input	Cooling	Nom. kW	0.60	1.09	1.55
	Heating	Nom. kW	0.77	1.19	1.60
Space cooling	Energy efficiency class			A++	
	Capacity	Pdesign kW	2.50	3.50	5.00
	SEER		7.20	6.43	6.80
	Annual energy consumption	kWh/a	120	190	257
Space heating (Average climate)	Energy efficiency class			A+	
	Capacity	Pdesign kW	2.40	2.90	4.20
	SCOP/A		4.56	4.00	
	Annual energy consumption	kWh/a	737	1,015	1,471
Nominal efficiency	EER		4.20	3.21	3.23
	COP		4.42	3.78	3.63
	Annual energy consumption	kWh	298	545	773
	Energy labeling Directive	Cooling/Heating		A/A	

Indoor unit		FVXM	25F	35F	50F
Dimensions	Unit	HeightxWidthxDpeth	600x700x210		
Weight	Unit	kg	14		
Air filter	Type	Removable / washable			
Fan	Air flow rate	Cooling	Silent operation/Low/Medium/High	m³/min	
		Heating	Silent operation/Low/Medium/High	m³/min	
Sound power level	Cooling		52		57
	Heating		52		58
Sound pressure level	Cooling	Silent operation/Low/High	23/26/38		32/36/44
	Heating	Silent operation/Low/High	23/26/38		32/36/45

Outdoor unit		RXM	25R9	35R9	50R
Dimensions	Unit	HeightxWidthxDpeth	552x840x350		734x954x401
Weight	Unit	kg	32		49.0
Sound power level	Cooling	Nom. dBA	58.0		61.0
	Heating	Nom. dBA	59.0		61.0
Sound pressure level	Cooling	Nom. dBA	46.0		49.0
	Heating	Nom. dBA	47.0		49.0
Operation range	Cooling	Ambient Min.-Max.	°CDB		-10~46
	Heating	Ambient Min. - Max.	°CDB		-15~24
Refrigerant	Type	R-32			
	GWP	675			
Piping connections	Charge	kg/TCO2Eq	0.76/0.52		1.15/0.780
	Liquid	OD	mm		6
	Gas	OD	mm		12.7
	Piping length	OU - IU Max. System Chargeless	m		30
Power supply	Additional refrigerant charge	kg/m	0.02 (for piping length exceeding 10m)		
	Level difference	IU - OU Max.	m		20.0
Current - 50Hz	Phase/Frequency/Voltage	Hz/V	1~50 / 220-240		
	Maximum fuse amps (MFA)	A	13		16

See separate drawing for electrical data | See separate drawing for operation range | Nominal cooling capacities are based on: indoor temperature: 27°CDB, 19°CWB, outdoor temperature: 35°CDB, equivalent refrigerant piping: 5m, level difference: 0m. | Nominal heating capacities are based on: indoor temperature: 20°CDB, outdoor temperature: 7°CDB, 6°CWB, equivalent refrigerant piping: 5m, level difference: 0m. | 50Hz, 220-230-240V | 220V | 230V | 240V | Contains

Concealed ceiling unit

Compact concealed ceiling unit, with a height of only 200mm

- › Invisible unit as the unit is concealed in the ceiling: only the suction and discharge grilles are visible
- › Compact dimensions, can easily be mounted in a ceiling void of only 240mm
- › Medium external static pressure up to 40Pa facilitates unit use with flexible ducts of varying lengths
- › Unified indoor unit range for R-32 and R-410A
- › Auto cleaning filter option ensures maximum efficiency, comfort and reliability by regular filter cleaning
- › Multi zoning kit allows multiple individually-controlled climate zones to be served by one indoor unit
- › Onecta app (optional): control your indoor from any location with an app, via your local network or internet.
- › Voice command via Amazon Alexa or Google Assistant to control main functions such as set point, operation mode, fan speed, etc
- › Low energy consumption thanks to DC fan motor



More details and final information can be found by scanning or clicking the QR codes.



FDXM-F9



RXM-R



RXM-R9

Efficiency data		FDXM + RXM		25F9 + 25R		35F9 + 35R		50F9 + 50R		60F9 + 60R			
Cooling capacity	Min./Nom./Max.	kW		1.30/2.40/3.00		1.40/3.40/3.80		1.70/5.00/5.30		1.70/6.00/6.50			
Heating capacity	Min./Nom./Max.	kW		1.30/3.20/4.50		1.40/4.00/5.00		1.70/5.80/6.00		1.70/7.00/7.10			
Space cooling	Energy efficiency class			A ⁺		A		A ⁺		A			
	Capacity	Pdesign	kW	2.40		3.40		5.00		6.00			
	SEER			5.68		5.26		5.77		5.56			
	Annual energy consumption		kWh/a	148		226		303		378			
Space heating (Average climate)	Energy efficiency class			A ⁺				A					
	Capacity	Pdesign	kW	2.60		2.90		4.00		4.60			
	SCOP/A			4.24		3.88		3.93		3.80			
	Annual energy consumption		kWh/a	858		1,046		1,424		1,693			
Indoor unit		FDXM		25F9		35F9		50F9		60F9			
Dimensions	Unit	HeightxWidthxDepth		mm		200x750x620		200x1,150x620					
Weight	Unit			kg		21		28					
Air filter	Type					Removable/washable							
Fan	Air flow rate	Cooling	Low/Medium/High	m ³ /min	7.3/8.0/8.7		13.3/14.6/15.8		13.5/14.8/16.0				
		Heating	Low/Medium/High	m ³ /min	7.3/8.0/8.7		13.3/14.6/15.8		13.5/14.8/16.0				
	External static pressure	Nom.		Pa	30		40						
Sound power level	Cooling			dBA	53.0		55.0		56.0				
	Heating			dBA	53.0		55.0		56.0				
Sound pressure level	Cooling	Low/High		dBA	27.0/35.0		30.0/38.0						
	Heating	Low/High		dBA	27.0/35.0		30.0/38.0						
Control systems	Infrared remote control												
Outdoor unit		RXM		25R9		35R9		50R		60R			
Dimensions	Unit	HeightxWidthxDepth		mm		550x765x285		734x870x373					
Weight	Unit			kg		32		49.0					
Sound power level	Cooling	Nom.		dBA	58		61		62.0		63.0		
	Heating	Nom.		dBA	59		61		62.0		63.0		
Sound pressure level	Cooling	Nom.		dBA	46		49		48.0				
	Heating	Nom.		dBA	47		49		49.0				
Operation range	Cooling	Ambient	Min.~Max.	°CDB			-10~46						
	Heating	Ambient	Min. - Max.	°CDB			-15~24						
Refrigerant	Type					R-32							
	GWP					675		675.0					
	Charge			kg/CO ₂ Eq	0.76/0.52		1.15/0.780						
Piping connections	Liquid	OD		mm			6.35						
	Gas	OD		mm	9.50				12.7				
	Piping length	OU - IU	Max.	m	20				30				
		System	Chargeless		m	10							
		Additional refrigerant charge			kg/m			0.02 (for piping length exceeding 10m)					
	Level difference	IU - OU	Max.	m	15				20.0				
Power supply	Phase/Frequency/Voltage				Hz/V		1~/50 /220-240						
Current - 50Hz	Maximum fuse amps (MFA)				A		13		16				

See separate drawing for electrical data | See separate drawing for operation range | Nominal cooling capacities are based on: indoor temperature: 27°CDB, 19°CWB, outdoor temperature: 35°CDB, equivalent refrigerant piping: 5m, level difference: 0m. | Nominal heating capacities are based on: indoor temperature: 20°CDB, outdoor temperature: 7°CDB, 6°CWB, equivalent refrigerant piping: 5m, level difference: 0m. | Contains fluorinated greenhouse gases

Multi model application

- > New design outlook for full range
- > Seasonal efficiency values up to A+++ in cooling and A++ in heating thanks to its up-to-date technology and built-in intelligence
- > Up to 5 indoor units can be connected to 1 multi outdoor unit; all indoor units are individually controllable and do not need to be installed in the same room or at the same time. They operate simultaneously within the same heating or cooling mode.
- > Choosing for an R-32 product, reduces the environmental impact with 68% compared to R-410A and leads directly to lower energy consumption thanks to its high energy efficiency
- > Different types of indoor units can be connected: e.g. wall mounted, ceiling mounted cassette corner, concealed ceiling unit
- > Outdoor units are fitted with a swing compressor, renowned for its low noise and high energy efficiency



CONNECTABLE INDOOR UNITS	CTXA-AW/BS/BT/BB	Wall mounted											Concealed ceiling						Floor standing			Round flow	Fully flat	Ceiling suspended	Concealed floor standing																							
		FTXA-AW/BS/BT/BB					CTXM-R	FTXM-R					FTXJ-AW/S/B			FTXP-M9			FDXM-F9			FBA-A9	CVXM-A	FVXM-A	FVXM-F	FCAG-B	FFA-A9	FHA-A9	FNA-A9																			
		15	20	25	35	42	15	20	25	35	42	50	60	71	20	25	35	42	50	20	25	35	42	50	35	50	60	20	25	35	50	35	50	60	25	35	50	60	35	50	60	25	35	50	60			
2MXM40A	•	•	•	•	•	•	•	•	•									•	•	•	•	•	•	•	•	•																						
2MXM50A	•	•	•	•	•	•	•	•	•									•	•	•	•	•	•	•	•	•																						
2MXM68A	•	•	•	•	•	•	•	•	•									•	•	•	•	•	•	•	•	•																						
3MXM40A	•	•	•			•	•	•	•									•	•	•	•						•	•	•																			
3MXM52A	•	•	•			•	•	•	•									•	•	•	•						•	•	•																			
3MXM68A	•	•	•			•	•	•	•									•	•	•	•						•	•	•																			
4MXM68A	•	•	•			•	•	•	•									•	•	•	•						•	•	•																			
4MXM80A	•	•	•			•	•	•	•									•	•	•	•						•	•	•																			
5MXM90A	•	•	•			•	•	•	•									•	•	•	•						•	•	•																			

More details and final information can be found by scanning or clicking the QR codes.



2MXM-A



3MXM-A



4MXM-A



5MXM-A

Outdoor unit				2MXM40A	2MXM50A	2MXM68A	3MXM40A	3MXM52A	3MXM68A	4MXM68A	4MXM80A	5MXM90A					
Dimensions	Unit	Height	Width	Depth	mm			552x852x350			734x958x340		734x974x401		734x958x340		
Weight	Unit				kg			36	41	60.0	57	62.0	63.0	67.0	68.0		
Sound power level	Cooling				dB(A)			60	61.0	59.0	61.0	64.0					
Sound pressure level	Cooling	Nom./High	dB(A)			-/46	-/48	48.0/-	46/-	48.0/-	52.0/-						
	Heating	Nom./High	dB(A)			-/48	-/50	48.0/-	47/-	-/-	49.0/-	52.0/-					
Operation range	Cooling	Ambient	Min.-Max.			°CDB			-10~46								
	Heating	Ambient	Min.-Max.			°CWB			-15~18								
Refrigerant	Type				R-32												
	GWP				675.0												
Piping connections	Charge	kg/CO2Eq			0.88/0.60	1.15/0.78	2.00/1.35	1.80/1.22	2.00/1.35	2.40/1.62							
	Liquid	OD	mm			6.4	6.35	6.4	6.35								
	Gas	OD	mm			9.5	9.50	9.5	9.50								
	Piping length	OU - IU	Max.			m			20 (1)								
	Additional refrigerant charge	System	Chargeless			m			-								
		System	Chargeless			kg/m			0.02 (for piping length exceeding 20m)								
Power supply	Level difference	IU - OU	Max.			m			15.0								
	Phase/Frequency/Voltage	Hz/V			1~/50/220-230-240			1~/50/220-240									
Current - 50Hz	Maximum fuse amps (MFA)			A			16	20	16	20	25	32					

(1)For one room | See separate drawing for operation range | See separate drawing for electrical data | Contains fluorinated greenhouse gases | For combination with CVXM-A, FVXM-A - maximum piping length is 30m.

Multi+

Only one system for domestic hot water + air conditioning

- › New design outlook for outdoor unit
- › Seasonal efficiency values up to A+++ in cooling and A++ for air conditioning
- › Domestic hot water efficiencies up to A
- › Wall mounted domestic hot water tank, available in 90l and 120l
- › Up to 3 indoor units can be connected to 1 multi outdoor unit; all indoor units are individually controllable and do not need to be installed in the same room or at the same time. They operate simultaneously within the same heating or cooling mode.
- › Choosing for an R-32 product, reduces the environmental impact with 68% compared to R-410A and leads directly to lower energy consumption thanks to its high energy efficiency
- › Different types of indoor units can be connected: e.g. wall mounted, ceiling mounted cassette corner, concealed ceiling unit
- › The outdoor unit is fitted with a swing compressor, renowned for its low noise and high energy efficiency



CONNECTABLE INDOOR UNITS	Wall mounted												Concealed ceiling					Floor standing	Round flow	Fully flat	Ceiling mounted	Concealed floor standing	Domestic hot water tank																		
	C/FTXA-AW/BS/BT/BB						C/FTXM-R						FTXJ-AW/S/B					FDXM-F9	FBA-A9	FVXM-F	FCAG-B	FFA-A9	FHA-A9	FNA-A9	EKHWT-BV3																
	15	20	25	35	42	50	15	20	25	35	42	50	20	25	35	42	50	25	35	50	35	50	60	71	25	35	50	35	50	25	35	50	35	50	25	35	50	25	35	50	90
4MWXM52A	•	•	•	•	•	•	•	•	•	•	•	•	•	•	•	•	•	•	•	•	•	•	•	•	•	•	•	•	•	•	•	•	•	•	•	•	•	•			

* No combination with additional indoor units possible

Efficiency data				EKHWT90BV3 + 4MWXM52A	EKHWT90BV3 + 4MWXM52A
Heating capacity	Nom.		kW	-	-
COP	Average climate			2,19	2,30
	Warm climate			2,68	2,70
Heat-up time	Average climate		h:mm	1:18	2:15
	Warm climate		h:mm	1:53	3:35
Seasonal efficiency	Domestic hot water heating	General	Declared load profile	M	L
		Average climate	η _{wh} (water heating efficiency)	%	-
Water heating energy efficiency class*				A	
Water temperature	by heat pump		Max.	50	

*EN16147(2017)

Domestic hot water tank				EKHWT	90BV3	120BV3
Casing	Colour				White	
Material					Enameled steel	
Dimensions		HeightxWidthxDepth	mm		1032x536x571	1296x536x571
Weight			kg		60	70
Tank	Water volume		l		90	120
	Energy efficiency class*				B	
Operation range	Heating	Ambient	Min.~Max.	°C	-15 ~ 42	
		Water side	Min.~Max.	°C	-	-

* LOT 2

Outdoor unit				4MWXM	52A
Dimensions	Unit	HeightxWidthxDepth	mm		734x974x401
Weight	Unit		kg		57
Sound power level	Cooling				59
Sound pressure level	Cooling	Nom./High	dBA		59
	Heating	Nom./High	dBA		46
Operation range	Cooling	Ambient	Min.~Max.	°CDB	47
	Heating	Ambient	Min.~Max.	°CWB	-10~+50
Refrigerant	Type				-20~+24
	GWP				R-32/675.0
	Charge		kg/TCO2Eq		1.80/1.22
Piping connections DX	Liquid	OD	mm		6.35
	Gas	OD	mm		9.50/12.7/15.9
Piping connections DHW	Liquid	OD	mm		6.35
	Gas	OD	mm		9.50
Piping length	OU - IU		Max.	m	25
	Additional refrigerant charge			kg/m	0.02 (for piping length exceeding 10m)
Level difference	IU - OU		Max.	m	15
Power supply	Phase/Frequency/Voltage			Hz/V	1~/50 /220-240
Current - 50Hz	Maximum fuse amps (MFA)			A	10

*Note: blue cells contain preliminary data

Optimised for heating



Designed for living: solutions for even the coldest regions

Designed for colder climates, Optimised Heating 4 creates a comfortable interior environment while maintaining excellent energy efficiency ratings.

Reliability

To guarantee the seamless operation of your heating system, even in temperatures as low as -25°C , the Optimised Heating 4 range offers enhanced features.

Easy Installation: long piping

The Daikin Optimised 4 offers a quick and easy installation process, which includes extended piping: This longer piping is specifically adapted to accommodate the thicker walls of Scandinavian buildings, and help contractors cut down on installation time.

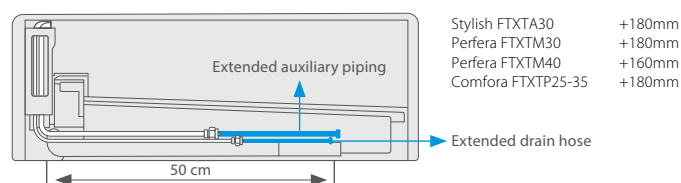

The fireplace scenario

Stylish FTXTA and Perfera FTXTM are flexible and easy to adapt for any room, including spaces that contain additional heat sources, such as a fireplace.

- > If the temperature in the room reaches the desired point set by user, the operation FIREPLACE LOGIC (if activated) will start automatically.
- > The unit will distribute hot air from the external source across the room using the unit's fan.
- > The fan speed and the intensity of distribution depends on difference between temperature set by user and actual temperature in the room (in case of big difference between these temperatures the air distribution will be more intensive)

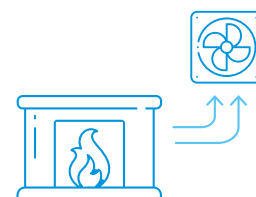

Measured temperature in the room \geq set temperature
= Thermo off Fan auto adjust according to ΔT

The Coanda effect

The **Coanda effect** optimises the airflow for a comfortable climate. By using specially designed flaps, a more focused airflow allows a better temperature distribution throughout the whole room

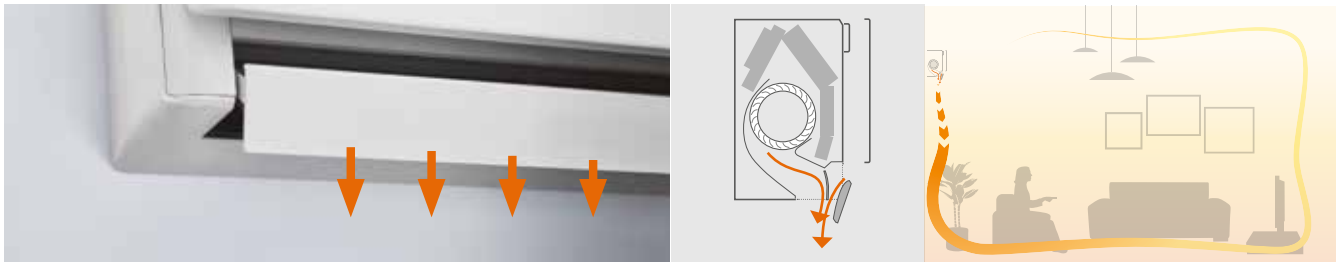

Quiet operation

Stylish uses a **specially designed fan** to optimise airflow for higher energy efficiency at low sound levels. Sound dispersion and noise reduction are the results of a special fan design.

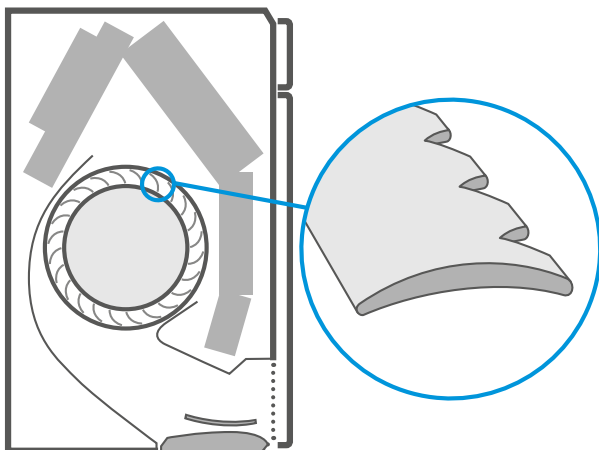

Dual Airflow

Our floor standing FVXM is ideal for heating comfort thanks to its dual airflow. Wide air flow coverage in both upward and downward directions allowing even air distribution.

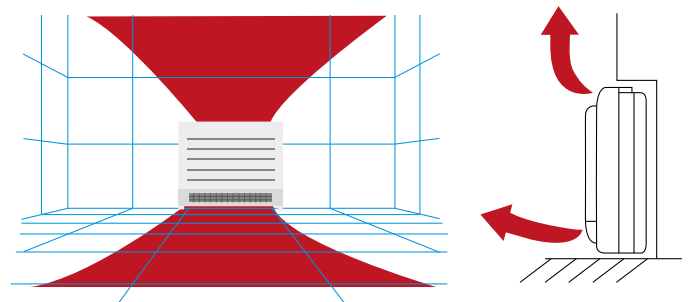

During heating operating, your feet stay warm and the temperature through the room is evenly distributed. Maximum comfort will be ensured.















Intelligent thermal sensor

Stylish uses an Intelligent thermal sensor to detect the surface temperature of a room to create a more comfortable climate. After determining the current room temperature, the grid eye sensor distributes air evenly throughout the room before switching to an airflow pattern that directs warm or cool air to areas that need it.



Bluevolution Range

BLUEEVOLUTION

Type	Model	Product Name	25	30	35	40
Wall mounted	Stylish: Where innovation meets creativity, even at ambient temperatures down to -25°C	FTXTA-BW/BB 				
Wall mounted	Perfera: Discreet, modern design for optimal efficiency and comfort thanks to 2-area motion detector sensor	FTXTM-R 				
Wall mounted	Comfora: Wall mounted unit, providing high efficiency and comfort while reducing the environmental impact	FTXTP-M 				
Floor Standing Unit	Design floor standing unit for optimal heating comfort thanks to unique heating features	FVXM-A 				
Wall mounted	Wall mounted unit Siesta: providing high efficiency and comfort while reducing the environmental impact	ATXTP-M 				

* Space heating - average climate

Wall mounted unit

Where innovation meets creativity, even at ambient temperatures down to -25°C

- › Guaranteed heating capacity at low ambient temperature, down to -25°C
- › When installed close to a heating device (e.g. fire place or oven) and the set temperature is reached, the fan keeps on running to have an even temperature throughout the whole house
- › A compact and functional design suitable for all interiors in a matt black and crystal white finish
- › The Coanda effect optimises the airflow for a comfortable climate. By using specially designed flaps, a more focused airflow allows a better temperature distribution throughout the whole room
- › The intelligent thermal sensor determines the current room temperature and distributes air evenly throughout the room before switching to an airflow pattern that directs warm or cool air to areas that need it
- › Onecta app: control your indoor from any location with an app, via your local network or internet.
- › Voice command via Amazon Alexa or Google Assistant to control main functions such as set point, operation mode, fan speed, etc
- › Choosing for an R-32 product, reduces the environmental impact with 68% compared to R-410A and leads directly to lower energy consumption thanks to its high energy efficiency
- › Seasonal efficiency values up to A+++ in cooling and heating
- › Using electrons to trigger chemical reactions with air borne particles, the Flash Streamer breaks down allergens such as pollen and fungal allergens and removes bothersome odours providing a better, cleaner air
- › Practically inaudible: the unit runs so quietly, you will almost forget it is there.
- › Heat boost quickly heats up your home when starting up your air conditioner. Set temperature is reached 14% faster than a regular air conditioner (pair only)



More details and final information can be found by scanning or clicking the QR codes.



Efficiency data		FTXTA + RXTA		30BB/BW + 30B	
Cooling capacity	Min./Nom./Max.	kW		0.70/3.00/4.50	
Heating capacity	Min./Nom./Max.	kW		0.80/3.20/6.90	
Power input	Cooling	Nom.	kW	0.71	
	Heating	Nom.	kW	0.66	
Space cooling	Energy efficiency class			A**	
	Capacity	Pdesign	kW	3.00	
	SEER			7.63	
	Annual energy consumption	kWh/a		138	
Space heating (Average climate)	Energy efficiency class			A+++	
	Capacity	Pdesign	kW	2.60	
	SCOP/A			5.10	
	Annual energy consumption	kWh/a		714	
Space heating (Cold climate)	Energy efficiency class			A*	
	Capacity	Pdesignh	kW	3.80	
	Annual energy consumption	kWh/a		1,946	
	SCOP/C			4.10	
Nominal efficiency	EER			4.20	
	COP			4.87	
	Annual energy consumption	kWh		357	
Energy labeling Directive		Cooling/Heating		A/A	
Indoor unit		FTXTA		30BB/BW	
Dimensions	Unit	HeightxWidthxDepth		mm	
Weight	Unit			kg	
Air filter	Type			Removable/washable	
Fan	Air flow rate	Cooling	Silent operation/Low/Medium/High	m³/min	
		Heating	Silent operation/Low/Medium/High	m³/min	
Sound power level	Cooling			dBA	
	Heating			dBA	
Sound pressure level	Cooling	Silent operation/Low/High		dBA	
	Heating	Silent operation/Low/High		dBA	
Control systems	Infrared remote control				ARC466A59
Outdoor unit		RXTA		30B	
Dimensions	Unit	HeightxWidthxDepth		mm	
Weight	Unit			kg	
Sound power level	Cooling	Nom.	dBA	61.0	
	Heating	Nom.	dBA	61.0	
Sound pressure level	Cooling	Nom.	dBA	48	
	Heating	Nom.	dBA	49	
Operation range	Cooling	Ambient	Min.--Max.	°CDB	
	Heating	Ambient	Min.--Max.	°CWB	
Refrigerant	Type/GWP			R-32/675	
	Charge	kg/CO2Eq		1.1/0.75	
Piping connections	Liquid/Gas	OD	mm	6.35/9.50	
	Piping length	OU - IU	Max.	m	
	Additional refrigerant charge			kg/m	
	Level difference	IU - OU	Max.	m	
Power supply	Phase/Frequency/Voltage		Hz/V		1~/50 /220-240
Current - 50Hz	Maximum fuse amps (MFA)		A		16

Nominal cooling capacities are based on: indoor temperature: 27°CDB, 19°CWB, outdoor temperature: 35°CDB, equivalent refrigerant piping: 5m, level difference: 0m. | Nominal heating capacities are based on: indoor temperature: 20°CDB, outdoor temperature: 7°CDB, 6°CWB, equivalent refrigerant piping: 5m, level difference: 0m. | See separate drawing for electrical data | See separate drawing for operation range | Cooling: indoor temp. 27°CDB, 19.0°CWB; outdoor temp. 35°CDB, 24°CWB; equivalent piping length: 5m | Heating: indoor temp. 20°CDB; outdoor temp. 7°CDB, 6°CWB; equivalent refrigerant piping: 5m | Contains fluorinated greenhouse gases

Wall mounted unit

Attractive, wall mounted design with perfect indoor air quality down to -25°C

- › Guaranteed heating capacity at low ambient temperature, down to -25°C
- › Seasonal efficiency values up to A+++ in cooling and heating
- › When installed close to a heating device (e.g. fire place or oven) and the set temperature is reached, the fan keeps on running to have an even temperature throughout the whole house
- › Heat boost quickly heats up your home when starting up your air conditioner. Set temperature is reached 14% faster than a regular air conditioner (pair only)
- › Using electrons to trigger chemical reactions with air borne particles, the Flash Streamer breaks down allergens such as pollen and fungal allergens and removes bothersome odours providing a better, cleaner air
- › Silver allergen removal and air purifying filter captures allergens such as pollen to ensure a steady supply of clean air
- › Voice command via Amazon Alexa or Google Assistant to control main functions such as set point, operation mode, fan speed, etc
- › Onecta app: control your indoor from any location with an app, via your local network or internet.
- › 2 area motion detection sensor: air flow is sent to a zone other than where the person is located at that moment; if no people are detected, the unit will automatically switch over to the energy-efficient setting.
- › 3-D air flow combines vertical and horizontal auto swing to circulate a stream of warm or cool air right to the corners of even large spaces



- › Quiet operation: down to 19dBA sound pressure level
- › Sleek, unobtrusive air conditioning unit that matches European sensibilities regarding interior design
- › Choosing for an R-32 product, reduces the environmental impact with 68% compared to R-410A and leads directly to lower energy consumption thanks to its high energy efficiency

More details and final information can be found by scanning or clicking the QR codes.



FTXTM-R



RXTM-R

Efficiency data		FTXTM + RXTM		30R + 30R		40R + 40R	
Cooling capacity	Min./Nom./Max.	kW		0.70/3.00/4.50		0.90/4.00/5.10	
Heating capacity	Min./Nom./Max.	kW		0.80/3.20/6.70		1.20/4.00/7.20	
Power input	Cooling	Nom.	kW	0.73		1.08	
	Heating	Nom.	kW	0.60		0.74	
Space cooling	Energy efficiency class			A**			
	Capacity	Pdesign	kW	3.00		4.00	
	SEER			7.60		7.70	
	Annual energy consumption		kWh/a	138		182	
Space heating (Average climate)	Energy efficiency class			A+++			
	Capacity	Pdesign	kW	3.00		3.80	
	SCOP/A			5.12		5.30	
	Annual energy consumption		kWh/a	821		1,003	
Space heating (Cold climate)	Energy efficiency class			A*			
	Capacity	Pdesignh	kW	4.38		5.55	
	Annual energy consumption		kWh/a	2,276		2,803	
	SCOP/C			4.04		4.16	
Nominal efficiency	EER			4.10		3.71	
	COP			5.34		5.37	
	Annual energy consumption		kWh	366		539	
	Energy labeling Directive	Cooling/Heating		A/A			

Indoor unit		FTXTM		30R		40R		
Dimensions	Unit	HeightxWidthxDepth		mm		295x778x272		
Weight	Unit	kg		10.0		14.5		
Air filter	Type			Removable/washable				
Fan	Air flow rate	Cooling	Silent operation/Low/Medium/High	m³/min		4.1/5.3/7.8/12.2		
		Heating	Silent operation/Low/Medium/High	m³/min		5.9/7.1/10.5/17.5		
Sound power level	Cooling			dBA		60.0		
	Heating			dBA		61.0		
Sound pressure level	Cooling	Silent operation/Low/High		dBA		21.0/25.0/45.0		
	Heating	Silent operation/Low/High		dBA		19.0/22.0/45.0		
Control systems	Infrared remote control				ARC466A75			

Outdoor unit		RXTM		30R		40R	
Dimensions	Unit	HeightxWidthxDepth		mm		551x763x312	
Weight	Unit	kg		38		38	
Sound power level	Cooling	Nom.	dBA	61.0		61.0	
	Heating	Nom.	dBA	61.0		61.0	
Sound pressure level	Cooling	Nom.	dBA	48		48	
	Heating	Nom.	dBA	49		49	
Operation range	Cooling	Ambient	Min.-Max.	°CDB		-10~46	
	Heating	Ambient	Min.-Max.	°CWB		-25~18	
Refrigerant	Type/GWP			R-32/675			
	Charge	kg/TCO2Eq		1.1/0.74			
Piping connections	Liquid/Gas	OD		mm		6.35/9.50	
	Piping length	OU - IU	Max.	m		20	
	Additional refrigerant charge			kg/m		0.02 (for piping length exceeding 10m)	
	Level difference	IU - OU	Max.	m		15	
Power supply	Phase/Frequency/Voltage			Hz/V		1~/50 /220-240	
	Current - 50Hz	Maximum fuse amps (MFA)		A		16	

Nominal heating capacities are based on: indoor temperature: 20°CDB, outdoor temperature: 7°CDB, 6°CWB, equivalent refrigerant piping: 5m, level difference: 0m. | Nominal cooling capacities are based on: indoor temperature: 27°CDB, 19°CWB, outdoor temperature: 35°CDB, equivalent refrigerant piping: 5m, level difference: 0m. | See separate drawing for operation range | See separate drawing for electrical data | Cooling: indoor temp. 27°CDB, 19.0°CWB; outdoor temp. 35°CDB, 24°CWB; equivalent piping length: 5m | Heating: indoor temp. 20°CDB; outdoor temp. 7°CDB, 6°CWB; equivalent refrigerant piping: 5m | See separate drawings for electrical data | Contains fluorinated greenhouse gases

Wall mounted unit

Wall mounted unit providing high efficiency and comfort down to -25°C

- › Guaranteed heating capacity at low ambient temperature, down to -25°C
- › The unit's compact dimensions makes it ideal for renovation projects, especially for above door installation
- › Seasonal efficiency values: full range A++ in cooling and heating
- › Onecta app: control your indoor from any location with an app, via your local network or internet.
- › Voice command via Amazon Alexa or Google Assistant to control main functions such as set point, operation mode, fan speed, etc
- › Space saving contemporary wall mounted design
- › Choosing for an R-32 product, reduces the environmental impact with 68% compared to R-410A and leads directly to lower energy consumption thanks to its high energy efficiency
- › 3-D air flow combines vertical and horizontal auto swing to circulate a stream of warm or cool air right to the corners of even large spaces



More details and final information can be found by scanning or clicking the QR codes.



FTXTP-M



RXTP-R

Efficiency data		FTXTP + RXTP		25M + 25R		35M + 35R	
Cooling capacity	Min./Nom./Max.	kW		0.80/2.50/4.00		0.80/3.50/4.40	
Heating capacity	Min./Nom./Max.	kW		1.20/3.20/6.20		1.20/4.00/6.70	
Power input	Cooling	Nom.	kW	0.57		0.92	
	Heating	Nom.	kW	0.65		0.90	
Space cooling	Energy efficiency class			A++			
	Capacity	Pdesign	kW	2.50		3.50	
	SEER			7.10		7.20	
	Annual energy consumption		kWh/a	123		170	
Space heating (Average climate)	Energy efficiency class			A++			
	Capacity	Pdesign	kW	2.50		3.00	
	SCOP/A			4.93		4.81	
	Annual energy consumption		kWh/a	710		873	
Space heating (Cold climate)	Energy efficiency class			A			
	Capacity	Pdesignh	kW	3.65		4.38	
	Annual energy consumption		kWh/a	1,941		2,394	
	SCOP/C			3.95		3.84	
Nominal efficiency	EER			4.40		3.80	
	COP			4.95		4.44	
	Annual energy consumption		kWh	284		461	
	Energy labeling Directive	Cooling/Heating		A/A			

Indoor unit		FTXTP		25M		35M	
Dimensions	Unit	HeightxWidthxDepth		mm		286x770x225	
Weight	Unit	kg		9.00			
Air filter	Type	Removable/washable					
Fan	Air flow rate	Cooling	Silent operation/Low/Medium/High	m³/min		3.9/5.5/8.3/11.5	
		Heating	Silent operation/Low/Medium/High	m³/min		4.5/5.6/8.7/11.5	
Sound power level	Cooling	dBA		58			
	Heating	dBA		58			
Sound pressure level	Cooling	Silent operation/Low/High		dBA		21/26/43	
	Heating	Silent operation/Low/High		dBA		21/26/43	
Control systems	Infrared remote control		ARC480A53				

Outdoor unit		RXTP		25R		35R	
Dimensions	Unit	HeightxWidthxDepth		mm		551x763x312	
Weight	Unit	kg		38			
Sound power level	Cooling	Nom.	dBA	61.0			
	Heating	Nom.	dBA	61.0			
Sound pressure level	Cooling	Nom.	dBA	48			
	Heating	Nom.	dBA	49			
Operation range	Cooling	Ambient	Min.-Max.	°CDB		-10~-46	
	Heating	Ambient	Min.-Max.	°CWB		-25~-18	
Refrigerant	Type	R-32					
	GWP	675					
	Charge	kg/CO2Eq		1.1/0.75			
Piping connections	Liquid	OD	mm	6.35			
	Gas	OD	mm	9.50			
	Piping length	OU - IU	Max.	m		20	
	Additional refrigerant charge	kg/m		0.02 (for piping length exceeding 10m)			
	Level difference	IU - OU	Max.	m		15	
Power supply	Phase/Frequency/Voltage		Hz/V		1~/50 /220-240		
Current - 50Hz	Maximum fuse amps (MFA)		A		16		

Nominal heating capacities are based on: indoor temperature: 20°CDB, outdoor temperature: 7°CDB, 6°CWB, equivalent refrigerant piping: 5m, level difference: 0m. | Nominal cooling capacities are based on: indoor temperature: 27°CDB, 19°CWB, outdoor temperature: 35°CDB, equivalent refrigerant piping: 5m, level difference: 0m. | See separate drawing for operation range | See separate drawing for electrical data | Cooling: indoor temp. 27°CDB, 19.0°CWB; outdoor temp. 35°CDB, 24°CWB; equivalent piping length: 5m | Heating: indoor temp. 20°CDB; outdoor temp. 7°CDB, 6°CWB; equivalent refrigerant piping: 5m (horizontal) | Contains fluorinated greenhouse gases

Floor standing unit

Design floor standing unit for optimal heating comfort thanks to unique heating features

- › Seasonal efficiency values up to A++ in heating, resulting in low running costs compared to gas boilers and electric heating
- › Excellent contemporary design
- › Heat boost quickly heats up your home when starting up your air conditioner. Set temperature is reached 14% faster than a regular air conditioner (pair only)
- › The floor warming function optimises convection by distributing hot air from the bottom of the unit
- › The heat plus function provides 30 minutes cosy heating by simulating radiant heat
- › Dual air discharge flow for better air distribution
- › Using electrons to trigger chemical reactions with air borne particles, the Flash Streamer breaks down allergens such as pollen and fungal allergens and removes bothersome odours providing a better, cleaner air
- › Onecta app: control your indoor from any location with an app, via your local network or internet.
- › Quiet operation: down to 19dBa sound pressure level

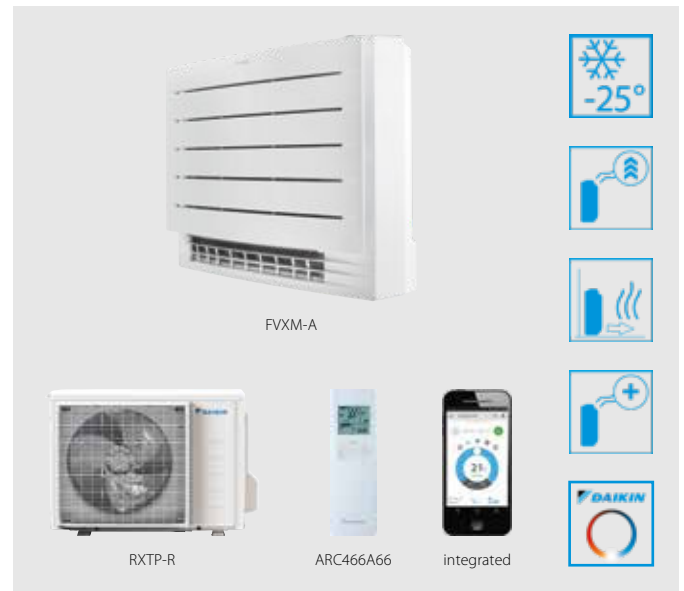

More details and final information can be found by scanning or clicking the QR codes.



FVXM-A



RXTP-R

Efficiency data				FVXM + RXTP	25A + 25R	35A + 35R	
Cooling capacity	Min./Nom./Max.		kW	1.40/2.50/4.20		1.40/3.50/4.30	
Heating capacity	Min./Nom./Max.		kW	1.20/3.20/5.70		1.20/4.00/6.20	
Power input	Cooling	Nom.	kW	0.66		1.02	
	Heating	Nom.	kW	0.83		1.13	
Space cooling	Energy efficiency class			A++			
	Capacity	Pdesign	kW	2.50		3.50	
	SEER			6.50		6.10	
	Annual energy consumption		kWh/a	135		201	
Space heating (Average climate)	Energy efficiency class			A++			
	Capacity	Pdesign	kW	2.50		3.00	
	SCOP/A			4.70		4.60	
	Annual energy consumption		kWh/a	744		913	
Space heating (Cold climate)	Energy efficiency class			A			
	Capacity	Pdesignh	kW	3.65		4.38	
	Annual energy consumption		kWh/a	2,032		2,573	
	SCOP/C			3.77		3.58	
Nominal efficiency	EER			3.81		3.43	
	COP			3.86		3.54	
	Annual energy consumption		kWh	328		510	
	Energy labeling Directive		Cooling/Heating	A/A		A/B	
Indoor unit				FVXM	25A	35A	
Dimensions	Unit	HeightxWidthxDepth		mm			
Weight	Unit			kg			
Air filter	Type	Removable/washable					
Fan	Air flow rate	Cooling	Silent operation/Low/Medium/High	m³/min		4.1/4.9/7/8.7	
		Heating	Silent operation/Low/Medium/High	m³/min		4.1/5.6/7.2/9.2	
Sound power level	Cooling			dBA		52.0	
	Heating			dBA		53.0	
Sound pressure level	Cooling	Silent operation/Low/High		dBA		20.0/25.0/38.0	
	Heating	Silent operation/Low/High		dBA		19.0/25.0/38.0	
Control systems	Infrared remote control		ARC466A66				
Outdoor unit				RXTP	25R	35R	
Dimensions	Unit	HeightxWidthxDepth		mm			
Weight	Unit			kg			
Sound power level	Cooling	Nom.		dBA		61.0	
	Heating	Nom.		dBA		61.0	
Sound pressure level	Cooling	Nom.		dBA		48	
	Heating	Nom.		dBA		49	
Operation range	Cooling	Ambient	Min.--Max.	°CDB		-10~46	
	Heating	Ambient	Min.--Max.	°CWB		-25~18	
Refrigerant	Type	R-32					
	GWP	675					
	Charge	kg/CO2Eq		1.1/0.75			
Piping connections	Liquid	OD		mm		6.35	
	Gas	OD		mm		9.50	
	Piping length		OU - IU	Max.	m		20
	Additional refrigerant charge				kg/m		0.02 (for piping length exceeding 10m)
	Level difference		IU - OU	Max.	m		15
Power supply	Phase/Frequency/Voltage		Hz/V			1~/50 /220-240	
Current - 50Hz	Maximum fuse amps (MFA)		A			16	

Nominal cooling capacities are based on: indoor temperature: 27°CDB, 19°CWB, outdoor temperature: 35°CDB, equivalent refrigerant piping: 5m, level difference: 0m. | Nominal heating capacities are based on: indoor temperature: 20°CDB, outdoor temperature: 7°CDB, 6°CWB, equivalent refrigerant piping: 5m, level difference: 0m. | See separate drawing for electrical data | See separate drawing for operation range | Cooling: indoor temp. 27°CDB, 19°CWB; outdoor temp. 35°CDB, 24°CWB; equivalent piping length: 5m | Heating: indoor temp. 20°CDB; outdoor temp. 7°CDB, 6°CWB; equivalent refrigerant piping: 5m | Contains fluorinated greenhouse gases

INDOOR UNITS		FTXZ-N	FTXJ-AW/S/B	C/FTXA-AW/BS/BT/BB	C/FTXM-R	FTXP-M(9)	FTXF-D	FTXC-C	FTXQ-A
Online control system	BRP069B* Onecta app WIFI adapter for smart phone	BRP069B42	Standardly included	Standardly included	Standardly included	BRP069B45	BRP069B45	BRP069B45	BRP069B45
	BRC1E53A/B/C (3)(4)(5) / BRC1H51(9)W/S/K / BRC1H81W/S Premium wired remote control with full-text interface and back-light								
Individual control systems	BRC073A1 (9) Wired remote control (cord for wired remote control required)		•	•	•	•	•		
	BRC2E52C Simplified remote control (with operation mode selector button)								
	BRC3E52C Remote control for hotel use								
	BRC4C65 Infrared remote control								
	BRCW901A03 Extension cord for wired remote control (3m)		•	•	•	•			
	BRCW901A08 Extension cord for wired remote control (8m)		•	•	•	•			
Centralised control systems	KRC72A Centralised control board (up to 5 rooms)	•	•		•				
	DCC601A51 Centralised controller with cloud connection by using the adapter KRP928*	•	•	•	•	•	•		
	DCS302CA51 Central remote control	•	•	•	•	•	•		
	DCS301BA51 Unified ON/OFF control	•	•	•	•	•	•		
	DCS303A51 Residential central remote control								
	DST301BA51 Schedule timer	•	•	•	•	•	•		
	DCM601A51 Intelligent Touch Manager	•	•	•	•	•	•		•
	EKMBDXA Modbus interface	•	•	•	•	•	•		
Building Management System & Standard protocol interface	RTD-RA (9) Modbus gateway	•	•	•	•	•	•		
	KLIC-DD (9) KNX interface	•	•	•	•	•	•		
	BRP7A54 (7)(8) Adapter PCB for interlock (key card, ...)								
Adapters	KRP1B56 Adapter for wiring								
	KRP413AB15 Adapter for wiring normal open contact/normal open pulse contact (time clock and other devices to be purchased locally)	•	•	•	•				
	KRP4A54 Adapter for external ON/OFF and monitoring for electrical appendices								
	KRP2A53 Wiring adapter for electrical appendices								
	Installation box for adapter PCBs (when there is no space in the switchbox)								
	KRP980A1 Interface adapter for wired remote control								
	KRP928BB25 Interface adapter for DIII-net	•	•	•	•	•	•		•
	DTA114A61 Multi tenant								
	KRCS01-4 External wired temperature sensor			•					
	KJB212AA/KJB311A Electrical box with earth terminal (2 blocks / 3 blocks)								
	Filters	KAF970A46 Titanium apatite deodorising filter without frame		•	•		•		•
KAF057A41 Silver particle filter (Ag-ion filter) with frame				•					
KAF046A41 Honeycomb deodorising and air purifying filter with frame		•							
KAF968A42 Honeycomb deodorising and air purifying filter with frame		•							
KEK26-1A Noise filter (for electromagnetic use only)									
BAE20A62/102 Auto-cleaning filter (small/large)									
Others	Anti-theft protection for remote control	KKF936A4	KKF910AA4	KKF910AA4			KKF936A4		
	Wire harness to connect to S21 connector			EKRS21					
	KDT25N32/50/63 Insulation kit for high humidity								

(1) Can be used only in combination with KRP980A1
(2) WLAN installation kit include interface adapter PCB
(3) BRC1E53A: included languages: English, German, French, Italian, Spanish, Dutch, Greek, Russian, Turkish, Portuguese, Polish
(4) BRC1E53B: included languages: English, German, Czech, Hungarian, Romanian, Slovenian, Bulgarian, Slovak, Serbian, Albanian
(5) BRC1E53C: included languages
(6) Installation box for adapter PCB is necessary. Hour meter is field supply and should not be installed inside the equipment.

(7) Installation box for adapter PCB is necessary. They require mounting plate KRP4A96, maximally 2 optional PCBs can be mounted.
(8) Only in combination with simplified remote control BRC2E52C or BRC3E52C.
(9) Wiring adapter supplied by Daikin. Time clock and other devices: to be purchased locally.
(10) Standard there is no remote control delivered with this indoor unit. Wired or infrared control to be ordered separately.
(11) Standard delivered with the unit.

R-32 and R-410A	R-32		Optimised heating				
	R-32		R-32				
FDXM-F9	C/FVXM-A	FVXM-F	FTXTA-AW	FTXTM-R	FTXTP-M	ATXTP-M	FVXM-A
BRP069A81	Standardly included	BRP069B42	Standardly included	Standardly included	Standardly included	BRP069B41	Standardly included
•							
	•	•	•	•	•	•	•
•							
•							
•(10)							
	•	•	•	•	•	•	•
	•	•	•	•	•	•	•
		•		•			
•	•	•	•	•	•	•	•
•	•	•	•	•	•	•	•
•	•	•	•	•	•	•	•
•							
•	•	•	•	•	•	•	•
•	•	•	•	•	•	•	•
•	•	•	•	•	•	•	•
•	•	•	•	•	•	•	•
•	•	•	•	•	•	•	•
•							
•							
	•	•	•	•			•
•							
•							
KRP1BA101							
	•	•	•	•	•	•	•
•							
•			•				
•							
	•		•		•	•	•
			•				
•							
•							
		KKF910AA4	KKF910AA4		KKF936A4	KKF936A4	KKF910AA4
	EKRS21		EKRS21				EKRS21
•							



(1) Can be used only in combination with KRP980A1
(2) WLAN installation kit include interface adapter PCB
(3) BRC1E53A: included languages: English, German, French, Italian, Spanish, Dutch, Greek, Russian, Turkish, Portuguese, Polish
(4) BRC1E53B: included languages: English, German, Czech, Hungarian, Romanian, Slovenian, Bulgarian, Slovak, Serbian, Albanian
(5) BRC1E53C: included languages
(6) Installation box for adapter PCB is necessary. Hour meter is field supply and should not be installed inside the equipment.

(7) Installation box for adapter PCB is necessary. They require mounting plate KRP4A96, maximally 2 optional PCBs can be mounted.
(8) Only in combination with simplified remote control BRC2E52C or BRC3E52C.
(9) Wiring adapter supplied by Daikin. Time clock and other devices: to be purchased locally.
(10) Standard there is no remote control delivered with this indoor unit. Wired or infrared control to be ordered separately.
(11) Standard delivered with the unit.

Combinatietabellen

Binnenunit	Koelcapaciteit [kW]		Totale koelcapaciteit [kW]			Opgenomen vermogen koelen [kW]			Totale stroom koelen [A]			Verwarmingscapaciteit [kW]		Totale verwarmingscapaciteit [kW]		
	Kamer A	Kamer B	Min.	Nom.	Max.	Min.	Nom.	Max.	Min.	Nom.	Max.	Kamer A	Kamer B	Min.	Nom.	Max.
1,5	1,50	0,00	1,30	1,50	2,00	0,33	0,31	0,40	1,78	1,70	2,17	2,00	---	1,00	2,00	3,30
2,0	2,00	0,00	1,30	2,00	2,40	0,33	0,44	0,57	1,78	2,38	3,09	3,00	---	1,00	3,00	3,70
2,5	2,50	0,00	1,30	2,50	3,00	0,33	0,61	0,80	1,78	3,33	4,40	3,40	---	1,00	3,40	4,10
3,5	3,50	0,00	1,30	3,50	4,00	0,33	1,04	1,35	1,78	5,71	7,38	3,80	---	1,00	3,80	4,40
1,5+1,5	1,50	1,50	1,50	3,00	3,60	0,31	0,60	0,73	1,67	3,33	4,00	1,75	1,75	1,20	3,50	4,30
1,5+2,0	1,50	2,00	1,50	3,50	4,00	0,31	0,79	0,91	1,67	4,35	4,98	1,63	2,17	1,20	3,80	4,50
1,5+2,5	1,50	2,50	1,50	4,00	4,20	0,31	0,98	1,03	1,67	5,37	5,64	1,58	2,63	1,20	4,20	4,60
1,5+3,5	1,20	2,80	1,50	4,00	4,40	0,31	0,96	1,06	1,67	5,30	5,83	1,26	2,94	1,20	4,20	4,70
2,0+2,0	2,00	2,00	1,50	4,00	4,20	0,31	0,97	1,02	1,67	5,34	5,61	2,10	2,10	1,30	4,20	4,60
2,0+2,5	1,78	2,22	1,50	4,00	4,30	0,31	0,96	1,04	1,67	5,30	5,70	1,87	2,33	1,30	4,20	4,70
2,0+3,5	1,45	2,55	1,50	4,00	4,50	0,31	0,95	1,08	1,67	5,25	5,91	1,53	2,67	1,30	4,20	4,80
2,5+2,5	2,00	2,00	1,50	4,00	4,40	0,31	0,96	1,06	1,67	5,27	5,80	2,10	2,10	1,30	4,20	4,70
2,5+3,5	1,67	2,33	1,50	4,00	4,60	0,31	0,94	1,09	1,67	5,20	5,98	1,75	2,45	1,30	4,20	4,80

Minimaal 2 binnenunits aansluiten op deze buitenunit. Bovenstaande waarden zijn geldig voor de combinaties met CTXM-R, FTXM-R en FTXA. Voor andere combinaties dient u de energielabel generator te raadplegen.

Opgenomen vermogen verwarmen [kW]			Totale stroom verwarmen [A]			Vermogensfactor [%]	Seizoensgegevens koelen				Seizoensgegevens verwarmen (gemiddeld klimaat)					
Min.	Nom.	Max.	Min.	Nom.	Max.		label	SEER	Ontwerp-capaciteit	AEC	label	SCOP	Ontwerp-capaciteit	AEC	Opgegeven capaciteit bij -10°C	Capaciteit back-upverwarming bij -10°C
0,26	0,68	1,04	1,43	3,66	5,69	79	---	---	---	---	---	---	---	---	---	---
0,26	0,83	1,24	1,43	4,52	6,78	79	---	---	---	---	---	---	---	---	---	---
0,26	1,02	1,48	1,43	5,59	8,09	79	---	---	---	---	---	---	---	---	---	---
0,26	1,28	1,71	1,43	7,02	9,40	79	---	---	---	---	---	---	---	---	---	---
0,24	0,80	0,99	1,31	4,43	5,45	79	A+++	8,66	3,00	122	A++	4,62	3,00	908	2,50	0,50
0,24	0,88	1,04	1,31	4,85	5,75	79	A+++	8,60	3,50	143	A++	4,61	3,20	972	2,50	0,70
0,24	1,00	1,10	1,31	5,53	6,06	79	A+++	8,55	4,00	164	A++	4,60	3,20	972	2,60	0,60
0,24	0,96	1,12	1,31	5,29	5,92	79	A++	8,26	4,00	170	A++	4,63	3,20	968	2,70	0,50
0,24	0,98	1,08	1,31	5,41	5,93	79	A+++	8,53	4,00	165	A++	4,64	3,20	966	2,60	0,60
0,24	0,97	1,09	1,31	5,36	6,00	79	A+++	8,50	4,00	165	A++	4,60	3,20	973	2,70	0,50
0,24	0,95	1,09	1,31	5,25	6,00	79	A++	8,19	4,00	171	A++	4,60	3,20	974	2,80	0,40
0,24	0,96	1,08	1,31	5,29	5,92	79	A++	8,36	4,00	168	A++	4,60	3,20	974	2,70	0,50
0,24	0,94	1,08	1,31	5,19	5,94	79	A++	8,11	4,00	173	A++	4,61	3,20	971	2,80	0,40

Combinatietabellen

Binnenunit	Koelcapaciteit [kW]		Totale koelcapaciteit [kW]			Opgenomen vermogen koelen [kW]			Totale stroom koelen [A]			Verwarmingscapaciteit [kW]		Totale verwarmingscapaciteit [kW]		
	Kamer A	Kamer B	Min.	Nom.	Max.	Min.	Nom.	Max.	Min.	Nom.	Max.	Kamer A	Kamer B	Min.	Nom.	Max.
1,5	1,50	---	1,40	1,50	2,20	0,31	0,32	0,52	1,53	1,55	2,53	2,00	---	1,10	2,00	3,30
2,0	2,00	---	1,40	2,00	2,90	0,31	0,47	0,77	1,53	2,25	3,76	3,00	---	1,10	3,00	3,70
2,5	2,50	---	1,40	2,50	3,10	0,31	0,67	0,92	1,53	3,27	4,50	3,40	---	1,10	3,40	4,10
3,5	3,50	---	1,40	3,50	4,10	0,31	1,09	1,46	1,53	5,32	7,13	4,00	---	1,10	4,00	4,60
4,2	4,20	---	1,40	4,20	4,70	0,31	1,59	1,75	1,53	7,73	8,57	4,60	---	1,10	4,60	5,00
5,0	5,00	---	1,60	5,00	5,30	0,33	1,30	1,44	1,64	6,33	7,01	5,50	---	1,20	5,50	5,60
1,5+1,5	1,50	1,50	1,60	3,00	4,20	0,33	0,62	0,87	1,64	3,03	4,25	2,00	2,00	1,20	4,00	4,54
1,5+2,0	1,50	2,00	1,60	3,50	4,20	0,33	0,76	0,91	1,64	3,71	4,46	1,89	2,51	1,20	4,40	4,89
1,5+2,5	1,50	2,50	1,60	4,00	4,20	0,33	0,94	0,99	1,64	4,60	4,83	1,80	3,00	1,20	4,80	5,19
1,5+3,5	1,50	3,50	1,60	5,00	5,00	0,33	1,25	1,25	1,64	6,10	6,10	1,56	3,64	1,20	5,20	5,70
1,5+4,2	1,32	3,68	1,60	5,00	5,40	0,33	1,23	1,54	1,64	6,04	6,53	1,47	4,13	1,20	5,60	5,96
1,5+5,0	1,15	3,85	1,80	5,00	5,50	0,33	1,23	1,68	1,64	5,99	6,59	1,29	4,31	1,20	5,60	6,16
2,0+2,0	2,00	2,00	1,80	4,00	5,00	0,33	0,94	1,28	1,64	4,60	5,75	2,60	2,60	1,20	5,20	5,70
2,0+2,5	2,00	2,50	1,80	4,50	5,10	0,33	1,07	1,31	1,64	5,23	5,93	2,49	3,11	1,20	5,60	5,80
2,0+3,5	1,82	3,18	1,80	5,00	5,40	0,33	1,24	1,49	1,64	6,05	6,54	2,04	3,56	1,20	5,60	5,90
2,0+4,2	1,61	3,39	1,80	5,00	5,50	0,33	1,23	1,51	1,64	6,01	6,62	1,81	3,79	1,20	5,60	6,00
2,0+5,0	1,43	3,57	1,80	5,00	5,50	0,33	1,22	1,44	1,64	5,95	6,55	1,60	4,00	1,20	5,60	6,20
2,5+2,5	2,50	2,50	1,80	5,00	5,30	0,33	1,25	1,42	1,64	6,10	6,47	2,80	2,80	1,20	5,60	5,80
2,5+3,5	2,08	2,92	1,80	5,00	5,40	0,33	1,23	1,43	1,64	6,02	6,51	2,33	3,27	1,20	5,60	6,00
2,5+4,2	1,87	3,13	1,80	5,00	5,50	0,33	1,22	1,45	1,64	5,98	6,58	2,09	3,51	1,20	5,60	6,10
2,5+5,0	1,67	3,33	1,80	5,00	5,50	0,33	1,21	1,38	1,64	5,92	6,52	1,87	3,73	1,30	5,60	6,30
3,5+3,5	2,50	2,50	1,80	5,00	5,40	0,33	1,22	1,42	1,64	5,95	6,43	2,80	2,80	1,30	5,60	6,10
3,5+4,2	2,27	2,73	1,80	5,00	5,50	0,33	1,21	1,40	1,64	5,90	6,49	2,55	3,05	1,30	5,60	6,20
3,5+5,0	2,06	2,94	1,80	5,00	5,50	0,33	1,20	1,34	1,64	5,85	6,44	2,31	3,29	1,30	5,60	6,40
4,2+4,2	2,50	2,50	1,80	5,00	5,50	0,33	1,20	1,38	1,64	5,88	6,47	2,80	2,80	1,30	5,60	6,30

Minimaal 2 binnenunits aansluiten op deze buitenunit. Bovenstaande waarden zijn geldig voor de combinaties met CTXM-R, FTXM-R en FTXA. Voor andere combinaties dient u de energielabel generator te raadplegen.

Opgenomen vermogen verwarmen [kW]			Totale stroom verwarmen [A]			Vermogensfactor [%]	Seizoensgegevens koelen				Seizoensgegevens verwarmen (gemiddeld klimaat)					
Min.	Nom.	Max.	Min.	Nom.	Max.		label	SEER	Ontwerp-capaciteit	AEC	label	SCOP	Ontwerp-capaciteit	AEC	Opgegeven capaciteit bij -10°C	Capaciteit back-upverwarming bij -10°C
0,29	0,68	0,95	1,44	3,31	4,66	89	---	---	---	---	---	---	---	---	---	---
0,27	0,82	1,13	1,33	3,99	5,52	89	---	---	---	---	---	---	---	---	---	---
0,25	0,99	1,34	1,23	4,81	6,54	89	---	---	---	---	---	---	---	---	---	---
0,25	1,24	1,53	1,23	6,03	7,46	89	---	---	---	---	---	---	---	---	---	---
0,23	1,49	1,81	1,12	7,27	8,85	89	---	---	---	---	---	---	---	---	---	---
0,23	1,35	1,51	1,12	6,56	9,01	89	---	---	---	---	---	---	---	---	---	---
0,23	0,87	0,99	1,12	4,27	4,85	89	A+++	8,80	3,00	120	A++	4,79	3,30	965	2,80	0,50
0,23	1,02	1,13	1,12	4,97	5,53	89	A+++	8,74	3,50	141	A++	4,66	3,80	1140	3,00	0,80
0,23	1,18	1,27	1,12	5,75	6,22	89	A+++	8,64	4,00	162	A++	4,64	3,80	1146	3,20	0,60
0,25	1,28	1,40	1,23	6,25	6,86	89	A+++	8,52	5,00	206	A++	4,61	4,00	1214	3,40	0,60
0,25	1,37	1,46	1,23	6,71	7,15	89	A+++	8,55	5,00	205	A++	4,62	4,10	1241	3,40	0,70
0,25	1,37	1,50	1,23	6,68	7,35	89	A+++	8,50	5,00	206	A++	4,63	4,20	1269	3,40	0,80
0,23	1,27	1,40	1,12	6,22	6,82	89	A+++	8,71	4,00	161	A++	4,61	4,00	1214	3,40	0,60
0,23	1,37	1,42	1,12	6,68	6,92	89	A+++	8,67	4,50	182	A++	4,61	4,10	1244	3,40	0,70
0,25	1,36	1,43	1,23	6,65	7,01	89	A+++	8,54	5,00	205	A++	4,61	4,20	1275	3,40	0,80
0,25	1,36	1,46	1,23	6,63	7,11	89	A+++	8,54	5,00	205	A++	4,63	4,20	1268	3,40	0,80
0,25	1,35	1,50	1,23	6,60	7,31	89	A+++	8,51	5,00	208	A++	4,68	4,20	1255	3,40	0,80
0,23	1,37	1,42	1,12	6,71	6,95	89	A+++	8,53	5,00	205	A++	4,61	4,20	1275	3,40	0,80
0,25	1,38	1,48	1,23	6,76	7,25	89	A+++	8,56	5,00	205	A++	4,62	4,20	1272	3,40	0,80
0,25	1,39	1,51	1,23	6,79	7,40	89	A+++	8,57	5,00	204	A++	4,65	4,20	1265	3,40	0,80
0,25	1,41	1,58	1,23	6,88	7,74	89	A+++	8,52	5,00	206	A++	4,71	4,20	1249	3,40	0,80
0,25	1,40	1,52	1,23	6,83	7,44	89	A+++	8,57	5,00	205	A++	4,66	4,20	1262	3,40	0,80
0,25	1,40	1,55	1,23	6,84	7,58	89	A+++	8,60	5,00	204	A++	4,67	4,20	1258	3,40	0,80
0,25	1,42	1,63	1,23	6,95	7,95	89	A+++	8,52	5,00	206	A++	4,75	4,20	1238	3,40	0,80
0,25	1,41	1,58	1,23	6,88	7,74	89	A+++	8,56	5,00	205	A++	4,70	4,20	1251	3,40	0,80

Combinatietabellen

Binneneunit	Koelcapaciteit [kW]			Totale koelcapaciteit [kW]			Opgenomen vermogen koelen [kW]			Totale stroom koelen [A]			Verwarmingscapaciteit [kW]			Totale verwarmingscapaciteit [kW]		
	Kamer A	Kamer B	Kamer C	Min.	Nom.	Max.	Min.	Nom.	Max.	Min.	Nom.	Max.	Kamer A	Kamer B	Kamer C	Min.	Nom.	Max.
1,5	1,60	---	---	1,52	1,60	2,49	0,40	0,42	0,59	1,82	1,98	2,71	2,70	---	---	1,47	2,70	4,08
2,0	2,00	---	---	1,65	2,00	3,00	0,41	0,43	0,67	1,89	2,08	3,08	2,72	---	---	1,48	2,72	4,09
2,5	2,50	---	---	1,74	2,50	3,44	0,44	0,44	0,82	2,00	2,62	3,77	3,40	---	---	1,44	3,40	4,30
3,5	3,50	---	---	1,93	3,50	4,86	0,46	0,46	1,43	2,09	3,84	6,53	4,30	---	---	1,45	4,30	4,90
4,2	4,20	---	---	1,93	4,20	5,33	0,46	0,46	1,43	2,09	3,93	6,56	---	4,32	---	1,44	4,32	5,70
5,0	5,00	---	---	1,94	5,00	6,03	0,44	0,44	2,13	2,00	7,20	9,77	---	5,60	---	1,66	5,60	6,90
6,0	6,00	---	---	1,94	6,00	6,51	0,44	0,44	2,13	2,00	7,29	9,77	---	7,90	---	1,88	7,90	8,91
1,5+1,5	1,50	1,50	---	1,95	3,00	4,79	0,40	0,51	1,15	1,81	2,34	5,25	2,65	2,65	---	1,65	5,30	7,38
1,5+2,0	1,50	2,00	---	1,95	3,50	4,96	0,40	0,62	1,22	1,81	2,84	5,58	2,44	3,26	---	1,65	5,70	7,76
1,5+2,5	1,50	2,50	---	1,95	4,00	5,28	0,40	0,75	1,36	1,81	3,44	6,23	2,29	3,81	---	1,65	6,10	7,95
1,5+3,5	1,50	3,50	---	1,95	5,00	6,17	0,39	1,04	1,83	1,77	4,76	8,39	2,07	4,83	---	1,80	6,90	8,50
1,5+4,2	1,50	4,20	---	1,95	5,70	6,39	0,39	1,27	1,96	1,77	5,82	8,97	1,97	5,53	---	1,80	7,50	8,85
1,5+5,0	1,50	5,00	---	1,95	6,50	7,08	0,38	1,50	2,23	1,73	6,87	10,22	1,89	6,31	---	2,18	8,20	10,38
1,5+6,0	1,36	5,44	---	1,96	6,80	7,59	0,37	1,62	2,36	1,68	7,42	10,79	1,72	6,88	---	2,46	8,60	10,58
2,0+2,0	2,00	2,00	---	1,95	4,00	5,12	0,40	0,75	1,29	1,81	3,44	5,91	3,25	3,25	---	1,65	6,50	7,95
2,0+2,5	2,00	2,50	---	1,95	4,50	5,44	0,40	0,89	1,43	1,81	4,08	6,56	3,07	3,83	---	1,65	6,90	8,12
2,0+3,5	2,00	3,50	---	1,95	5,50	6,30	0,39	1,17	1,91	1,77	5,36	8,76	2,73	4,77	---	1,80	7,50	8,67
2,0+4,2	2,00	4,20	---	1,95	6,20	6,51	0,39	1,43	2,05	1,77	6,55	9,37	2,58	5,42	---	1,80	8,00	9,03
2,0+5,0	1,94	4,86	---	1,95	6,80	7,26	0,38	1,59	2,36	1,73	7,28	10,79	2,46	6,14	---	2,18	8,60	10,56
2,0+6,0	1,70	5,10	---	1,96	6,80	7,71	0,37	1,61	2,45	1,68	7,37	11,20	2,15	6,45	---	2,46	8,60	10,75
2,5+2,5	2,50	2,50	---	1,95	5,00	6,10	0,41	1,01	1,78	1,89	4,63	8,15	3,60	3,60	---	1,65	7,20	8,49
2,5+3,5	2,50	3,50	---	1,95	6,00	6,57	0,40	1,29	2,11	1,81	5,91	9,65	3,29	4,61	---	1,89	7,90	9,03
2,5+4,2	2,50	4,20	---	1,95	6,70	6,95	0,40	1,51	2,38	1,81	6,92	10,88	3,10	5,20	---	1,89	8,30	9,29
2,5+5,0	2,27	4,53	---	1,95	6,80	7,37	0,37	1,50	2,45	1,68	6,87	11,20	2,87	5,73	---	2,27	8,60	10,68
2,5+6,0	2,00	4,80	---	1,96	6,80	7,71	0,35	1,48	2,45	1,60	6,78	11,20	2,53	6,07	---	2,55	8,60	10,88
3,5+3,5	3,40	3,40	---	1,95	6,80	7,13	0,38	1,45	2,37	1,73	6,64	10,83	4,30	4,30	---	2,17	8,60	9,38
3,5+4,2	3,09	3,71	---	1,95	6,80	7,24	0,38	1,45	2,46	1,73	6,64	11,24	3,91	4,69	---	2,17	8,60	9,47
3,5+5,0	2,80	4,00	---	1,95	6,80	7,76	0,35	1,42	2,78	1,60	6,50	12,71	3,54	5,06	---	2,56	8,60	10,90
3,5+6,0	2,51	4,29	---	2,26	6,80	8,07	0,40	1,40	2,72	1,81	6,41	12,46	3,17	5,43	---	2,74	8,60	11,01
4,2+4,2	3,40	3,40	---	1,95	6,80	7,14	0,38	1,44	2,37	1,73	6,60	10,83	4,30	4,30	---	2,17	8,60	9,56
4,2+5,0	3,10	3,70	---	1,95	6,80	7,77	0,35	1,41	2,78	1,60	6,46	12,71	3,93	4,67	---	2,56	8,60	10,91
4,2+6,0	2,80	4,00	---	2,26	6,80	8,08	0,40	1,40	2,72	1,81	6,41	12,46	3,54	5,06	---	2,74	8,60	11,02

Minimaal 2 binneneunits aansluiten op deze buitenunit. Bovenstaande waarden zijn geldig voor de combinaties met CTXM-R, FTXM-R en FTXA. Voor andere combinaties dient u de energielabel generator te raadplegen.

Opgenomen vermogen verwarmen [kW]			Totale stroom verwarmen [A]			Vermogensfactor [%]	Seizoensgegevens koelen				Seizoensgegevens verwarmen (gemiddeld klimaat)						Seizoensgegevens verwarmen (warm klimaat)					
Min.	Nom.	Max.	Min.	Nom.	Max.		label	SEER	Ontwerp-capaciteit	AEC	label	SCOP	Ontwerp-capaciteit	AEC	Opgegeven capaciteit bij -10°C	Capaciteit back-upverwarming bij -10°C	label	SCOP	Ontwerp-capaciteit	AEC	Opgegeven capaciteit bij +2°C	Capaciteit back-upverwarming bij +2°C
0,42	0,72	1,22	1,91	3,35	5,59	95	---	---	---	---	---	---	---	---	---	---	---	---	---	---	---	---
0,43	0,73	1,28	1,95	3,39	5,64	95	---	---	---	---	---	---	---	---	---	---	---	---	---	---	---	---
0,42	1,02	1,37	1,91	4,72	6,08	95	---	---	---	---	---	---	---	---	---	---	---	---	---	---	---	---
0,40	1,41	1,75	1,82	6,50	7,15	95	---	---	---	---	---	---	---	---	---	---	---	---	---	---	---	---
0,40	1,40	2,04	1,82	6,46	7,15	95	---	---	---	---	---	---	---	---	---	---	---	---	---	---	---	---
0,39	1,82	2,59	1,78	8,43	8,70	95	---	---	---	---	---	---	---	---	---	---	---	---	---	---	---	---
0,37	2,62	2,64	1,69	12,13	12,08	95	---	---	---	---	---	---	---	---	---	---	---	---	---	---	---	---
0,36	1,19	1,83	1,63	5,45	8,38	95	A++	7,29	3,00	144	A	3,85	3,80	1380	3,07	0,73	A+++	6,08	4,40	1012	4,40	0
0,36	1,31	1,99	1,63	6,00	9,09	95	A++	7,53	3,50	163	A	3,85	3,80	1380	3,08	0,72	A+++	6,10	4,40	1010	4,40	0
0,36	1,43	2,06	1,63	6,55	9,43	95	A++	7,75	4,00	181	A	3,87	3,80	1373	3,09	0,71	A+++	6,11	4,40	1008	4,40	0
0,37	1,69	2,35	1,68	7,74	10,74	95	A++	7,80	5,00	225	A	3,86	4,30	1558	3,39	0,91	A+++	6,13	4,40	1005	4,40	0
0,37	1,90	2,57	1,68	8,70	11,75	95	A++	7,84	5,70	255	A	3,88	4,30	1548	3,40	0,90	A+++	6,14	4,40	1003	4,40	0
0,45	2,13	2,91	2,06	9,75	13,31	95	A++	7,86	6,50	290	A	3,87	4,50	1628	3,55	0,95	A+++	6,17	4,40	998	4,40	0
0,48	2,28	2,67	2,19	10,44	12,21	95	A++	7,81	6,80	305	A	3,91	4,80	1717	3,73	1,07	A+++	6,21	4,40	992	4,40	0
0,36	1,37	2,31	1,63	6,28	9,47	95	A++	7,75	4,00	181	A	3,91	3,80	1361	3,09	0,71	A+++	6,10	4,40	1009	4,40	0
0,36	1,52	2,32	1,63	6,96	9,81	95	A++	7,80	4,50	202	A	3,92	3,80	1354	3,10	0,70	A+++	6,12	4,40	1007	4,40	0
0,37	1,75	2,43	1,68	8,01	11,12	95	A++	7,91	5,50	244	A	3,86	4,30	1558	3,39	0,91	A+++	6,13	4,40	1004	4,40	0
0,37	1,98	2,66	1,68	9,07	12,17	95	A++	7,88	6,20	276	A	3,88	4,30	1550	3,40	0,90	A+++	6,15	4,40	1002	4,40	0
0,45	2,26	3,00	2,06	10,35	13,73	95	A++	7,78	6,80	306	A	3,90	4,50	1612	3,55	0,95	A+++	6,19	4,40	996	4,40	0
0,48	2,24	2,74	2,19	10,26	12,55	95	A++	7,71	6,80	309	A	3,93	4,80	1710	3,73	1,07	A+++	6,22	4,40	990	4,40	0
0,36	1,62	2,36	1,63	7,42	10,78	95	A++	7,81	5,00	224	A	3,85	4,00	1455	3,22	0,78	A+++	6,14	4,40	1004	4,40	0
0,38	1,91	2,66	1,72	8,75	12,17	95	A++	7,94	6,00	265	A	3,83	4,30	1569	3,40	0,90	A+++	6,13	4,40	1004	4,40	0
0,38	2,11	2,82	1,72	9,66	12,93	95	A++	7,99	6,70	294	A	3,86	4,30	1559	3,41	0,89	A+++	6,14	4,40	1003	4,40	0
0,46	2,24	3,09	2,11	10,26	14,15	95	A++	7,93	6,80	300	A	3,84	4,50	1637	3,59	0,91	A+++	6,14	4,40	1003	4,40	0
0,50	2,22	2,77	2,28	10,17	12,67	95	A++	7,90	6,80	301	A	3,91	4,80	1716	3,80	1,00	A+++	6,14	4,40	1002	4,40	0
0,42	2,26	2,86	1,94	10,35	13,09	95	A++	8,02	6,80	297	A+	4,00	4,80	1680	3,73	1,07	A+++	6,14	4,40	1003	4,40	0
0,42	2,26	2,91	1,94	10,35	13,31	95	A++	8,00	6,80	298	A+	4,01	4,80	1675	3,75	1,05	A+++	6,14	4,40	1002	4,40	0
0,51	2,22	3,13	2,32	10,17	14,32	95	A+++	7,92	6,80	301	A+	4,01	4,80	1675	3,78	1,02	A+++	6,14	4,40	1003	4,40	0
0,52	2,21	2,76	2,37	10,12	12,63	95	A++	7,89	6,80	302	A+	4,06	4,80	1652	3,79	1,01	A+++	6,14	4,40	1002	4,40	0
0,42	2,22	2,94	1,94	10,17	13,47	95	A++	7,98	6,80	298	A+	4,00	4,80	1679	3,76	1,04	A+++	6,16	4,40	1000	4,40	0
0,51	2,21	3,19	2,32	10,12	14,61	95	A++	7,90	6,80	302	A	3,93	5,20	1851	4,01	1,19	A+++	6,15	4,40	1001	4,40	0
0,51	2,20	2,79	2,32	10,07	12,76	95	A++	7,87	6,80	303	A+	4,03	5,20	1804	4,02	1,18	A+++	6,15	4,40	1002	4,40	0

Combinatietabellen

Binneneunit	Koelcapaciteit [kW]			Totale koelcapaciteit [kW]			Opgenomen vermogen koelen [kW]			Totale stroom koelen [A]			Verwarmingscapaciteit [kW]			Totale verwarmingscapaciteit [kW]		
	Kamer A	Kamer B	Kamer C	Min.	Nom.	Max.	Min.	Nom.	Max.	Min.	Nom.	Max.	Kamer A	Kamer B	Kamer C	Min.	Nom.	Max.
1,5	1,50	---	---	1,40	1,50	2,20	0,32	0,35	0,46	1,52	1,63	2,20	2,30	---	---	1,10	2,30	3,30
2,0	2,00	---	---	1,40	2,00	2,90	0,32	0,48	0,71	1,52	2,28	3,40	2,70	---	---	1,10	2,70	3,70
2,5	2,50	---	---	1,40	2,50	3,10	0,32	0,64	0,82	1,52	3,05	3,90	3,40	---	---	1,10	3,40	4,10
3,5	3,50	---	---	1,40	3,50	4,10	0,32	0,98	1,19	1,52	4,68	5,70	4,20	---	---	1,10	4,20	4,80
1,5+1,5	1,50	1,50	---	1,60	3,00	4,20	0,34	0,59	1,14	1,63	2,82	5,44	1,80	1,80	---	1,20	3,60	5,00
1,5+2,0	1,50	2,00	---	1,60	3,50	4,20	0,34	0,71	1,12	1,63	3,40	5,33	1,54	2,06	---	1,20	3,60	5,00
1,5+2,5	1,50	2,50	---	1,60	4,00	4,20	0,34	0,86	1,10	1,63	4,11	5,33	1,50	2,50	---	1,20	4,00	5,00
1,5+3,5	1,20	2,80	---	1,60	4,00	4,40	0,34	0,85	1,13	1,63	4,07	5,41	1,38	3,22	---	1,20	4,60	5,00
2,0+2,0	2,00	2,00	---	1,60	4,00	4,50	0,34	0,84	1,09	1,63	4,02	5,22	2,30	2,30	---	1,20	4,60	5,00
2,0+2,5	1,78	2,22	---	1,60	4,00	4,50	0,34	0,83	1,07	1,63	3,97	5,22	2,04	2,56	---	1,20	4,60	5,00
2,0+3,5	1,45	2,55	---	1,60	4,00	4,50	0,34	0,83	1,03	1,63	3,97	5,22	1,67	2,93	---	1,20	4,60	5,00
2,5+2,5	2,00	2,00	---	1,60	4,00	4,50	0,34	0,83	1,05	1,63	3,97	5,22	2,30	2,30	---	1,20	4,60	5,00
2,5+3,5	1,67	2,33	---	1,60	4,00	4,60	0,34	0,82	1,03	1,63	3,92	4,93	1,92	2,68	---	1,20	4,60	5,00
3,5+3,5	2,00	2,00	---	1,60	4,00	4,60	0,34	0,82	1,01	1,63	3,92	4,84	2,30	2,30	---	1,20	4,60	5,00
1,5+1,5+1,5	1,33	1,33	1,33	1,70	4,00	4,60	0,36	0,78	0,98	1,74	3,73	4,68	1,53	1,53	1,53	1,30	4,60	5,10
1,5+1,5+2,0	1,20	1,20	1,60	1,70	4,00	4,60	0,36	0,77	0,96	1,74	3,68	4,68	1,38	1,38	1,84	1,30	4,60	5,10
1,5+1,5+2,5	1,09	1,09	1,82	1,70	4,00	4,60	0,36	0,77	0,94	1,74	3,68	4,68	1,25	1,25	2,09	1,30	4,60	5,10
1,5+1,5+3,5	0,92	0,92	2,15	1,70	4,00	4,60	0,36	0,76	0,90	1,74	3,64	4,68	1,06	1,06	2,48	1,30	4,60	5,10
1,5+2,0+2,0	1,09	1,45	1,45	1,70	4,00	4,60	0,36	0,77	0,92	1,74	3,68	4,68	1,25	1,67	1,67	1,30	4,60	5,10
1,5+2,0+2,5	1,00	1,33	1,67	1,70	4,00	4,60	0,36	0,76	0,91	1,74	3,64	4,68	1,15	1,53	1,92	1,30	4,60	5,10
1,5+2,0+3,5	0,86	1,14	2,00	1,70	4,00	4,60	0,36	0,76	0,89	1,74	3,64	4,68	0,99	1,31	2,30	1,30	4,60	5,10
1,5+2,5+2,5	0,92	1,54	1,54	1,70	4,00	4,60	0,36	0,76	0,87	1,74	3,64	4,68	1,06	1,77	1,77	1,30	4,60	5,10
2,0+2,0+2,0	1,33	1,33	1,33	1,70	4,00	4,60	0,36	0,76	0,85	1,74	3,64	4,68	1,53	1,53	1,53	1,30	4,60	5,10
2,0+2,0+2,5	1,23	1,23	1,54	1,70	4,00	4,60	0,36	0,76	0,83	1,74	3,64	4,68	1,42	1,42	1,77	1,30	4,60	5,10
2,0+2,5+2,5	1,14	1,43	1,43	1,70	4,00	4,60	0,36	0,75	0,81	1,74	3,59	4,68	1,31	1,64	1,64	1,30	4,60	5,10

Minimaal 2 binneneunits aansluiten op deze buitenunit. Bovenstaande waarden zijn geldig voor de combinaties met CTXM-R, FTXM-R en FTXA. Voor andere combinaties dient u de energielabel generator te raadplegen.

Opgenomen vermogen verwarmen [kW]			Totale stroom verwarmen [A]			Vermogensfactor [%]	Seizoensgegevens koelen				Seizoensgegevens verwarmen (gemiddeld klimaat)						Seizoensgegevens verwarmen (warm klimaat)					
Min.	Nom.	Max.	Min.	Nom.	Max.		label	SEER	Ontwerp-capaciteit	AEC	label	SCOP	Ontwerp-capaciteit	AEC	Opgegeven capaciteit bij -10°C	Capaciteit back-upverwarming bij -10°C	label	SCOP	Ontwerp-capaciteit	AEC	Opgegeven capaciteit bij +2°C	Capaciteit back-upverwarming bij +2°C
0,30	0,60	0,82	1,38	2,77	3,83	91	---	---	---	---	---	---	---	---	---	---	---	---	---	---	---	---
0,30	0,76	1,23	1,38	3,51	5,75	91	---	---	---	---	---	---	---	---	---	---	---	---	---	---	---	---
0,30	1,01	1,28	1,38	4,68	5,96	91	---	---	---	---	---	---	---	---	---	---	---	---	---	---	---	---
0,30	1,42	1,71	1,38	6,60	7,98	91	---	---	---	---	---	---	---	---	---	---	---	---	---	---	---	---
0,32	0,69	1,30	1,49	3,23	6,07	91	A+++	8,64	3,00	122	A++	4,60	3,60	1096	3,10	0,5	A+++	5,35	3,80	993	3,80	0
0,32	0,69	1,28	1,49	3,23	5,96	91	A+++	8,59	3,50	143	A++	4,62	3,60	1091	3,10	0,5	A+++	5,39	3,80	987	3,80	0
0,32	0,86	1,26	1,49	4,03	5,96	91	A+++	8,51	4,00	164	A+	4,39	4,20	1338	3,50	0,7	A+++	5,35	3,80	995	3,80	0
0,32	0,98	1,22	1,49	4,59	5,96	91	A+++	8,50	4,00	165	A+	4,28	4,80	1570	4,00	0,8	A+++	5,37	3,80	990	3,80	0
0,32	0,97	1,25	1,49	4,54	5,85	91	A+++	8,52	4,00	165	A+	4,24	4,80	1582	3,90	0,9	A+++	5,40	3,80	985	3,80	0
0,32	0,98	1,23	1,49	4,59	5,85	91	A+++	8,52	4,00	165	A+	4,27	4,80	1572	3,90	0,9	A+++	5,38	3,80	988	3,80	0
0,32	0,97	1,19	1,49	4,54	5,85	91	A+++	8,50	4,00	165	A+	4,30	4,80	1560	4,00	0,8	A+++	5,36	3,80	992	3,80	0
0,32	0,96	1,21	1,49	4,49	5,85	91	A+++	8,51	4,00	165	A+	4,34	4,80	1548	3,90	0,9	A+++	5,38	3,80	988	3,80	0
0,32	0,95	1,17	1,49	4,45	5,85	91	A+++	8,50	4,00	165	A+	4,37	4,80	1537	4,00	0,8	A+++	5,36	3,80	991	3,80	0
0,32	0,94	1,15	1,49	4,40	5,75	91	A+++	8,50	4,00	165	A+	4,38	5,00	1598	4,10	0,9	A+++	5,34	3,80	996	3,80	0
0,32	0,89	1,02	1,49	4,17	4,79	91	A+++	8,55	4,00	164	A++	4,65	5,00	1505	4,10	0,9	A+++	5,45	3,80	976	3,80	0
0,32	0,89	1,01	1,49	4,17	4,72	91	A+++	8,55	4,00	164	A++	4,63	5,00	1511	4,10	0,9	A+++	5,42	3,80	981	3,80	0
0,32	0,89	0,99	1,49	4,17	4,63	91	A+++	8,54	4,00	164	A++	4,61	5,00	1517	4,10	0,9	A+++	5,40	3,80	986	3,80	0
0,32	0,88	0,97	1,49	4,12	4,53	91	A+++	8,53	4,00	165	A++	4,61	5,00	1518	4,10	0,9	A+++	5,37	3,80	990	3,80	0
0,32	0,88	0,95	1,49	4,12	4,44	91	A+++	8,53	4,00	164	A++	4,60	5,00	1520	4,10	0,9	A+++	5,38	3,80	989	3,80	0
0,32	0,87	0,93	1,49	4,07	4,35	91	A+++	8,54	4,00	164	A++	4,60	5,00	1521	4,10	0,9	A+++	5,37	3,80	991	3,80	0
0,32	0,87	0,91	1,49	4,07	4,25	91	A+++	8,53	4,00	165	A++	4,62	5,00	1515	4,10	0,9	A+++	5,37	3,80	991	3,80	0
0,32	0,88	0,87	1,49	4,12	4,07	91	A+++	8,53	4,00	165	A++	4,62	5,00	1513	4,10	0,9	A+++	5,36	3,80	992	3,80	0
0,32	0,87	0,89	1,49	4,07	4,16	91	A+++	8,52	4,00	165	A++	4,60	5,00	1521	4,10	0,9	A+++	5,35	3,80	994	3,80	0
0,32	0,87	0,86	1,49	4,07	4,02	91	A+++	8,51	4,00	165	A++	4,62	5,00	1515	4,10	0,9	A+++	5,35	3,80	994	3,80	0
0,32	0,86	0,84	1,49	4,03	3,93	91	A+++	8,50	4,00	165	A++	4,63	5,00	1512	4,10	0,9	A+++	5,34	3,80	996	3,80	0

Opgenomen vermogen verwarmen [kW]			Totale stroom verwarmen [A]			Vermogensfactor [%]	Seizoensgegevens koelen				Seizoensgegevens verwarmen (gemiddeld klimaat)						Seizoensgegevens verwarmen (warm klimaat)					
Min.	Nom.	Max.	Min.	Nom.	Max.		label	SEER	Ontwerp-capaciteit	AEC	label	SCOP	Ontwerp-capaciteit	AEC	Opgegeven capaciteit bij -10°C	Capaciteit back-upverwarming bij -10°C	label	SCOP	Ontwerp-capaciteit	AEC	Opgegeven capaciteit bij +2°C	Capaciteit back-upverwarming bij +2°C
0,40	0,42	0,59	1,82	1,98	2,71	95	---	---	---	---	---	---	---	---	---	---	---	---	---	---	---	---
0,42	0,43	0,60	1,91	2,08	2,75	95	---	---	---	---	---	---	---	---	---	---	---	---	---	---	---	---
0,44	0,55	0,82	2,00	2,62	3,77	95	---	---	---	---	---	---	---	---	---	---	---	---	---	---	---	---
0,46	0,80	1,43	2,09	3,84	6,53	95	---	---	---	---	---	---	---	---	---	---	---	---	---	---	---	---
0,46	0,82	1,44	2,09	3,93	6,57	95	---	---	---	---	---	---	---	---	---	---	---	---	---	---	---	---
0,44	1,50	2,13	2,00	7,20	9,77	95	---	---	---	---	---	---	---	---	---	---	---	---	---	---	---	---
0,44	1,52	2,13	2,00	7,29	9,77	95	---	---	---	---	---	---	---	---	---	---	---	---	---	---	---	---
0,40	0,60	1,15	1,81	2,75	5,25	95	A++	7,29	3,00	144	A	3,85	3,80	1380	3,07	0,73	A+++	6,08	4,40	1012	4,40	0
0,40	0,74	1,22	1,81	3,38	5,58	95	A++	7,53	3,50	163	A	3,85	3,80	1380	3,08	0,72	A+++	6,10	4,40	1010	4,40	0
0,40	0,89	1,36	1,81	4,08	6,23	95	A++	7,75	4,00	181	A	3,87	3,80	1373	3,09	0,71	A+++	6,11	4,40	1008	4,40	0
0,39	1,24	1,83	1,77	5,68	8,39	95	A++	7,80	5,00	225	A	3,86	4,30	1558	3,39	0,91	A+++	6,13	4,40	1005	4,40	0
0,39	1,51	1,96	1,77	6,90	8,96	95	A++	7,84	5,70	255	A	3,88	4,30	1548	3,40	0,90	A+++	6,14	4,40	1003	4,40	0
0,38	1,78	2,23	1,73	8,14	10,22	95	A++	7,86	6,50	290	A	3,87	4,50	1628	3,55	0,95	A+++	6,17	4,40	998	4,40	0
0,37	1,93	2,36	1,68	8,82	10,79	95	A++	7,81	6,80	305	A	3,91	4,80	1717	3,73	1,07	A+++	6,21	4,40	992	4,40	0
0,40	0,89	1,29	1,81	4,08	5,91	95	A++	7,75	4,00	181	A	3,91	3,80	1361	3,09	0,71	A+++	6,10	4,40	1009	4,40	0
0,40	1,06	1,43	1,81	4,86	6,56	95	A++	7,80	4,50	202	A	3,92	3,80	1354	3,10	0,70	A+++	6,12	4,40	1007	4,40	0
0,39	1,39	1,91	1,77	6,38	8,76	95	A++	7,91	5,50	244	A	3,86	4,30	1558	3,39	0,91	A+++	6,13	4,40	1004	4,40	0
0,39	1,70	2,05	1,77	7,77	9,37	95	A++	7,88	6,20	276	A	3,88	4,30	1550	3,40	0,90	A+++	6,15	4,40	1002	4,40	0
0,38	1,90	2,36	1,73	8,68	10,79	95	A++	7,78	6,80	306	A	3,90	4,50	1612	3,55	0,95	A+++	6,19	4,40	996	4,40	0
0,37	1,92	2,45	1,68	8,78	11,20	95	A++	7,71	6,80	309	A	3,93	4,80	1710	3,73	1,07	A+++	6,22	4,40	990	4,40	0
0,41	1,20	1,78	1,89	5,51	8,15	95	A++	7,81	5,00	224	A	3,85	4,00	1455	3,22	0,78	A+++	6,14	4,40	1004	4,40	0
0,40	1,54	2,11	1,81	7,03	9,65	95	A++	7,94	6,00	265	A	3,83	4,30	1569	3,40	0,90	A+++	6,13	4,40	1004	4,40	0
0,40	1,79	2,38	1,81	8,21	10,88	95	A++	7,99	6,70	294	A	3,86	4,30	1559	3,41	0,89	A+++	6,14	4,40	1003	4,40	0
0,37	1,78	2,45	1,68	8,15	11,20	95	A++	7,93	6,80	300	A	3,84	4,50	1637	3,59	0,91	A+++	6,14	4,40	1003	4,40	0
0,35	1,76	2,45	1,60	8,06	11,20	95	A++	7,90	6,80	301	A	3,91	4,80	1716	3,80	1,00	A+++	6,14	4,40	1002	4,40	0
0,38	1,73	2,37	1,73	7,90	10,83	95	A++	8,02	6,80	297	A+	4,00	4,80	1680	3,73	1,07	A+++	6,14	4,40	1003	4,40	0
0,38	1,72	2,46	1,73	7,87	11,24	95	A++	8,00	6,80	298	A+	4,01	4,80	1675	3,75	1,05	A+++	6,14	4,40	1002	4,40	0
0,35	1,68	2,78	1,60	7,71	12,71	95	A++	7,92	6,80	301	A+	4,01	4,80	1675	3,78	1,02	A+++	6,14	4,40	1003	4,40	0
0,40	1,67	2,72	1,81	7,63	12,46	95	A++	7,89	6,80	302	A+	4,06	4,80	1652	3,79	1,01	A+++	6,14	4,40	1002	4,40	0
0,38	1,71	2,37	1,73	7,84	10,83	95	A++	7,98	6,80	298	A+	4,00	4,80	1679	3,76	1,04	A+++	6,16	4,40	1000	4,40	0
0,35	1,68	2,78	1,60	7,68	12,71	95	A++	7,90	6,80	302	A	3,93	5,20	1851	4,01	1,19	A+++	6,15	4,40	1001	4,40	0
0,40	1,66	2,72	1,81	7,60	12,46	95	A++	7,87	6,80	303	A+	4,03	5,20	1804	4,02	1,18	A+++	6,15	4,40	1002	4,40	0
0,43	1,64	2,98	1,98	7,52	13,65	95	A++	7,88	6,80	302	A+	4,06	5,20	1793	4,05	1,15	A+++	6,14	4,40	1002	4,40	0
0,44	1,63	2,92	2,02	7,44	13,36	95	A++	7,85	6,80	304	A+	4,09	5,20	1779	4,08	1,12	A+++	6,14	4,40	1003	4,40	0
0,39	0,61	1,57	1,77	2,80	7,17	95	A+++	8,54	4,50	185	A+	4,07	5,30	1822	4,19	1,11	A+++	5,65	4,40	1090	4,40	0
0,39	0,70	1,65	1,77	3,21	7,54	95	A+++	8,52	4,80	198	A+	4,08	5,30	1817	4,20	1,10	A+++	5,65	4,40	1089	4,40	0
0,39	0,80	1,73	1,77	3,67	7,90	95	A+++	8,50	5,00	206	A+	4,09	5,30	1810	4,21	1,09	A+++	5,66	4,40	1089	4,40	0
0,38	1,56	1,92	1,73	7,14	8,80	95	A++	7,85	6,50	290	A+	4,14	5,30	1793	4,23	1,07	A+++	5,66	4,40	1087	4,40	0
0,38	1,80	2,05	1,73	8,24	9,37	95	A++	7,71	6,80	309	A+	4,15	5,30	1786	4,24	1,06	A+++	5,67	4,40	1086	4,40	0
0,36	1,75	2,22	1,64	8,01	10,14	95	A++	7,64	6,80	312	A+	4,23	5,30	1752	4,28	1,02	A+++	5,69	4,40	1081	4,40	0
0,40	1,73	2,17	1,85	7,92	9,94	95	A++	7,62	6,80	313	A+	4,27	5,30	1735	4,30	1,00	A+++	5,71	4,40	1079	4,40	0
0,39	1,01	1,61	1,77	4,63	7,37	95	A++	8,17	5,50	236	A+	4,09	5,30	1814	4,21	1,09	A+++	5,66	4,40	1088	4,40	0
0,39	1,32	1,81	1,77	6,05	8,27	95	A++	7,90	6,00	266	A+	4,10	5,30	1807	4,22	1,08	A+++	5,66	4,40	1087	4,40	0
0,38	1,80	2,01	1,73	8,24	9,21	95	A++	7,71	6,80	309	A+	4,14	5,30	1793	4,23	1,07	A+++	5,67	4,40	1085	4,40	0
0,38	1,79	2,14	1,73	8,20	9,78	95	A++	7,69	6,80	310	A+	4,15	5,30	1786	4,24	1,06	A+++	5,68	4,40	1084	4,40	0
0,36	1,74	2,31	1,64	7,97	10,55	95	A++	7,63	6,80	312	A+	4,23	5,30	1752	4,28	1,02	A+++	5,70	4,40	1080	4,40	0
0,40	1,72	2,26	1,85	7,88	10,35	95	A++	7,60	6,80	313	A+	4,27	5,30	1735	4,30	1,00	A+++	5,71	4,40	1077	4,40	0
0,38	1,63	1,92	1,73	7,46	8,80	95	A++	7,76	6,50	294	A+	4,12	5,30	1800	4,22	1,08	A+++	5,67	4,40	1086	4,40	0
0,36	1,79	2,23	1,64	8,20	10,18	95	A++	7,69	6,80	310	A+	4,16	5,30	1782	4,24	1,06	A+++	5,68	4,40	1084	4,40	0
0,36	1,78	2,35	1,64	8,15	10,75	95	A++	7,67	6,80	310	A+	4,19	5,30	1768	4,26	1,04	A+++	5,68	4,40	1084	4,40	0
0,36	1,74	2,35	1,64	7,97	10,75	95	A++	7,61	6,80	313	A+	4,27	5,30	1735	4,30	1,00	A+++	5,71	4,40	1079	4,40	0
0,41	1,71	2,44	1,89	7,83	11,16	95	A++	7,59	6,80	314	A+	4,31	5,30	1719	4,31	0,99	A+++	5,72	4,40	1077	4,40	0
0,37	1,77	2,45	1,68	8,11	11,20	95	A++	7,67	6,80	311	A+	4,20	5,30	1765	4,26	1,04	A+++	5,69	4,40	1082	4,40	0
0,37	1,76	2,58	1,68	8,06	11,81	95	A++	7,65	6,80	311	A+	4,22	5,30	1755	4,27	1,03	A+++	5,69	4,40	1082	4,40	0
0,33	1,72	2,72	1,52	7,88	12,46	95	A++	7,58	6,80	314	A+	4,30	5,30	1722	4,31	0,99	A+++	5,72	4,40	1077	4,40	0
0,41	1,70	2,53	1,89	7,79	11,57	95	A++	7,56	6,80	315	A+	4,34	5,30	1707	4,33	0,97	A+++	5,73	4,40	1075	4,40	0
0,37	1,75	2,68	1,68	8,01	12,26	95	A++	7,63	6,80	312	A+	4,24	5,30	1748	4,28	1,02	A+++	5,71	4,40	1079	4,40	0
0,33	1,71	2,77	1,52	7,83	12,67	95	A++	7,56	6,80	315	A+	4,32	5,30	1716	4,32	0,98	A+++	5,73	4,40	1075	4,40	0
0,39	1,34	1,68	1,77	6,14	7,70	95	A++	7,84	6,00	268	A+	4,08	5,30	1819	4,20	1,10	A+++	5,67	4,40	1086	4,40	0
0,39	1,63	1,89	1,77	7,46	8,64	95	A++	7,76	6,50	294	A+	4,09	5,30	1814	4,21	1,09	A+++	5,68	4,40	1085	4,40	0
0,38	1,79	2,09	1,73	8,20	9,57	95	A++	7,69	6,80	310	A+	4,13	5,30	1796	4,23	1,07	A+++	5,69	4,40	1083	4,40	0
0,38	1,78	2,23	1,73	8,15	10,18	95	A++	7,67	6,80	310	A+	4,14	5,30	1789	4,24	1,06	A+++	5,69	4,40	1082	4,40	0
0,36	1,74	2,39	1,64	7,97	10,96	95	A++	7,61	6,80	313	A+	4,22	5,30	1755	4,27	1,03	A+++	5,72	4,40	1077		

Combinatietabellen

Binnenuit	Koelcapaciteit [kW]			Totale koelcapaciteit [kW]			Opgenomen vermogen koelen [kW]			Totale stroom koelen [A]			Verwarmingscapaciteit [kW]			Totale verwarmingscapaciteit [kW]		
	Kamer A	Kamer B	Kamer C	Min.	Nom.	Max.	Min.	Nom.	Max.	Min.	Nom.	Max.	Kamer A	Kamer B	Kamer C	Min.	Nom.	Max.
2,0+3,5+5,0	1,30	2,27	3,24	2,28	6,80	8,58	0,40	1,69	2,82	1,85	7,74	12,91	1,30	2,27	3,24	2,28	6,80	8,58
2,0+4,2+4,2	1,31	2,75	2,75	1,96	6,80	8,37	0,37	1,73	2,77	1,68	7,92	12,67	1,31	2,75	2,75	1,96	6,80	8,37
2,5+2,5+2,5	2,27	2,27	2,27	1,96	6,80	7,53	0,38	1,76	2,18	1,73	8,06	9,98	2,27	2,27	2,27	1,96	6,80	7,53
2,5+2,5+3,5	2,00	2,00	2,80	1,96	6,80	7,94	0,36	1,72	2,45	1,64	7,88	11,20	2,00	2,00	2,80	1,96	6,80	7,94
2,5+2,5+4,2	1,85	1,85	3,10	1,96	6,80	8,12	0,36	1,71	2,58	1,64	7,83	11,81	1,85	1,85	3,10	1,96	6,80	8,12
2,5+2,5+5,0	1,70	1,70	3,40	2,28	6,80	8,45	0,40	1,67	2,72	1,85	7,65	12,46	1,70	1,70	3,40	2,28	6,80	8,45
2,5+2,5+6,0	1,55	1,55	3,71	2,42	6,80	8,74	0,40	1,65	2,67	1,85	7,56	12,22	1,55	1,55	3,71	2,42	6,80	8,74
2,5+3,5+3,5	1,79	2,51	2,51	2,27	6,80	8,30	0,40	1,70	2,72	1,85	7,79	12,46	1,79	2,51	2,51	2,27	6,80	8,30
2,5+3,5+4,2	1,67	2,33	2,80	2,27	6,80	8,43	0,40	1,69	2,82	1,85	7,74	12,91	1,67	2,33	2,80	2,27	6,80	8,43
2,5+3,5+5,0	1,55	2,16	3,09	2,48	6,80	8,74	0,42	1,65	2,96	1,94	7,56	13,56	1,55	2,16	3,09	2,48	6,80	8,74
2,5+4,2+4,2	1,56	2,62	2,62	2,27	6,80	8,49	0,40	1,68	2,87	1,85	7,69	13,12	1,56	2,62	2,62	2,27	6,80	8,49
3,5+3,5+3,5	2,27	2,27	2,27	2,38	6,80	8,59	0,40	1,68	2,96	1,81	7,69	13,56	2,27	2,27	2,27	2,38	6,80	8,59

Minimaal 2 binneneenheden aansluiten op deze buitenunit. Bovenstaande waarden zijn geldig voor de combinaties met CTXM-R, FTXM-R en FTXA. Voor andere combinaties dient u de energielabel generator te raadplegen.

Opgenomen vermogen verwarmen [kW]			Totale stroom verwarmen [A]			Vermogensfactor [%]	Seizoensgegevens koelen				Seizoensgegevens verwarmen (gemiddeld klimaat)					Seizoensgegevens verwarmen (warm klimaat)						
Min.	Nom.	Max.	Min.	Nom.	Max.		label	SEER	Ontwerp-capaciteit	AEC	label	SCOP	Ontwerp-capaciteit	AEC	Opgegeven capaciteit bij -10°C	Capaciteit back-upverwarming bij -10°C	label	SCOP	Ontwerp-capaciteit	AEC	Opgegeven capaciteit bij +2°C	Capaciteit back-upverwarming bij +2°C
0,40	1,69	2,82	1,85	7,74	12,91	95	A++	7,58	6,80	314	A+	4,28	5,30	1732	4,30	1,00	A+++	5,73	4,40	1074	4,40	0
0,37	1,73	2,77	1,68	7,92	12,67	95	A++	7,63	6,80	312	A+	4,32	5,30	1716	4,32	0,98	A+++	5,69	4,40	1082	4,40	0
0,38	1,76	2,18	1,73	8,06	9,98	95	A++	7,70	6,80	310	A+	4,12	5,30	1800	4,22	1,08	A+++	5,69	4,40	1083	4,40	0
0,36	1,72	2,45	1,64	7,88	11,20	95	A++	7,62	6,80	313	A+	4,16	5,30	1782	4,24	1,06	A+++	5,70	4,40	1081	4,40	0
0,36	1,71	2,58	1,64	7,83	11,81	95	A++	7,60	6,80	313	A+	4,18	5,30	1775	4,25	1,05	A+++	5,70	4,40	1080	4,40	0
0,40	1,67	2,72	1,85	7,65	12,46	95	A++	7,53	6,80	316	A+	4,26	5,30	1742	4,29	1,01	A+++	5,73	4,40	1075	4,40	0
0,40	1,65	2,67	1,85	7,56	12,22	95	A++	7,51	6,80	317	A+	4,30	5,30	1726	4,31	0,99	A+++	5,73	4,40	1074	4,40	0
0,40	1,70	2,72	1,85	7,79	12,46	95	A++	7,59	6,80	314	A+	4,20	5,30	1765	4,26	1,04	A+++	5,71	4,40	1077	4,40	0
0,40	1,69	2,82	1,85	7,74	12,91	95	A++	7,58	6,80	314	A+	4,22	5,30	1758	4,27	1,03	A+++	5,72	4,40	1077	4,40	0
0,42	1,65	2,96	1,94	7,56	13,56	95	A++	7,50	6,80	317	A+	4,30	5,30	1726	4,31	0,99	A+++	5,74	4,40	1073	4,40	0
0,40	1,68	2,87	1,85	7,69	13,12	95	A++	7,56	6,80	315	A+	4,23	5,30	1752	4,28	1,02	A+++	5,72	4,40	1077	4,40	0
0,40	1,68	2,96	1,81	7,69	13,56	95	A++	7,57	6,80	315	A+	4,24	5,30	1748	4,28	1,02	A+++	5,72	4,40	1076	4,40	0

Combinatietabellen

Binneneunit	Koelcapaciteit [kW]				Totale koelcapaciteit [kW]			Opgenomen vermogen koelen [kW]			Totale stroom koelen [A]			Verwarmingscapaciteit [kW]				Totale verwarmingscapaciteit [kW]		
	Kamer A	Kamer B	Kamer C	Kamer D	Min.	Nom.	Max.	Min.	Nom.	Max.	Min.	Nom.	Max.	Kamer A	Kamer B	Kamer C	Kamer D	Min.	Nom.	Max.
1,5	1,60	---	---	---	1,57	1,60	2,49	0,40	0,42	0,59	1,82	1,98	2,71	2,70	---	---	---	1,47	2,70	4,08
2,0	2,00	---	---	---	1,65	2,00	3,00	0,42	0,43	0,67	1,91	2,08	3,08	2,72	---	---	---	1,48	2,72	4,09
2,5	2,50	---	---	---	1,74	2,50	3,44	0,44	0,44	0,82	2,00	2,62	3,77	3,40	---	---	---	1,44	3,40	4,30
3,5	3,50	---	---	---	1,93	3,50	4,86	0,46	0,46	1,43	2,09	3,84	6,53	4,30	---	---	---	1,45	4,30	4,90
4,2	4,20	---	---	---	1,93	4,20	5,33	0,46	0,46	1,43	2,09	3,93	6,56	---	---	4,32	---	1,44	4,32	5,70
5,0	5,00	---	---	---	1,94	5,00	6,03	0,44	0,44	2,13	2,00	7,20	9,77	---	---	5,60	---	1,66	5,60	6,90
6,0	6,00	---	---	---	1,94	6,00	6,51	0,44	0,44	2,13	2,00	7,29	9,77	---	---	7,90	---	1,88	7,90	8,91
1,5+1,5	1,50	1,50	---	---	1,95	3,00	4,79	0,40	0,51	1,15	1,81	2,34	5,25	2,65	2,65	---	---	1,65	5,30	7,38
1,5+2,0	1,50	2,00	---	---	1,95	3,50	4,96	0,40	0,62	1,22	1,81	2,84	5,58	2,44	3,26	---	---	1,65	5,70	7,76
1,5+2,5	1,50	2,50	---	---	1,95	4,00	5,28	0,40	0,75	1,36	1,81	3,44	6,23	2,29	3,81	---	---	1,65	6,10	7,95
1,5+3,5	1,50	3,50	---	---	1,95	5,00	6,17	0,39	1,04	1,83	1,77	4,76	8,39	2,07	4,83	---	---	1,80	6,90	8,50
1,5+4,2	1,50	4,20	---	---	1,95	5,70	6,39	0,39	1,27	1,96	1,77	5,82	8,97	1,97	---	5,53	---	1,80	7,50	8,85
1,5+5,0	1,50	5,00	---	---	1,95	6,50	7,08	0,38	1,50	2,23	1,73	6,87	10,22	1,89	---	6,31	---	2,18	8,20	10,38
1,5+6,0	1,36	5,44	---	---	1,96	6,80	7,59	0,37	1,62	2,36	1,68	7,42	10,79	1,72	---	6,88	---	2,46	8,60	10,58
2,0+2,0	2,00	2,00	---	---	1,95	4,00	5,12	0,40	0,75	1,29	1,81	3,44	5,91	3,25	3,25	---	---	1,65	6,50	7,95
2,0+2,5	2,00	2,50	---	---	1,95	4,50	5,44	0,40	0,89	1,43	1,81	4,08	6,56	3,07	3,83	---	---	1,65	6,90	8,12
2,0+3,5	2,00	3,50	---	---	1,95	5,50	6,30	0,39	1,17	1,91	1,77	5,36	8,76	2,73	4,77	---	---	1,80	7,50	8,67
2,0+4,2	2,00	4,20	---	---	1,95	6,20	6,51	0,39	1,43	2,05	1,77	6,55	9,37	2,58	---	5,42	---	1,80	8,00	9,03
2,0+5,0	1,94	4,86	---	---	1,95	6,80	7,26	0,38	1,59	2,36	1,73	7,28	10,79	2,46	---	6,14	---	2,18	8,60	10,56
2,0+6,0	1,70	5,10	---	---	1,96	6,80	7,71	0,37	1,61	2,45	1,68	7,37	11,20	2,15	---	6,45	---	2,46	8,60	10,75
2,5+2,5	2,50	2,50	---	---	1,95	5,00	6,10	0,41	1,01	1,78	1,89	4,63	8,15	3,60	3,60	---	---	1,65	7,20	8,49
2,5+3,5	2,50	3,50	---	---	1,95	6,00	6,57	0,40	1,29	2,11	1,81	5,91	9,65	3,29	4,61	---	---	1,89	7,90	9,03
2,5+4,2	2,50	4,20	---	---	1,95	6,70	6,95	0,40	1,51	2,38	1,81	6,92	10,88	3,10	---	5,20	---	1,89	8,30	9,29
2,5+5,0	2,27	4,53	---	---	1,95	6,80	7,37	0,37	1,50	2,45	1,68	6,87	11,20	2,87	---	5,73	---	2,27	8,60	10,68
2,5+6,0	2,00	4,80	---	---	1,96	6,80	7,71	0,35	1,48	2,45	1,60	6,78	11,20	2,53	---	6,07	---	2,55	8,60	10,88
3,5+3,5	3,40	3,40	---	---	1,95	6,80	7,13	0,38	1,45	2,37	1,73	6,64	10,83	4,30	4,30	---	---	2,17	8,60	9,38
3,5+4,2	3,09	3,71	---	---	1,95	6,80	7,24	0,38	1,45	2,46	1,73	6,64	11,24	3,91	---	4,69	---	2,17	8,60	9,47
3,5+5,0	2,80	4,00	---	---	1,95	6,80	7,76	0,35	1,42	2,78	1,60	6,50	12,71	3,54	---	5,06	---	2,56	8,60	10,90
3,5+6,0	2,51	4,29	---	---	2,26	6,80	8,07	0,40	1,40	2,72	1,81	6,41	12,46	3,17	---	5,43	---	2,74	8,60	11,01
4,2+4,2	3,40	3,40	---	---	1,95	6,80	7,14	0,38	1,44	2,37	1,73	6,60	10,83	---	---	4,30	4,30	2,17	8,60	9,56
4,2+5,0	3,10	3,70	---	---	1,95	6,80	7,77	0,35	1,41	2,78	1,60	6,46	12,71	---	---	3,93	4,67	2,56	8,60	10,91
4,2+6,0	2,80	4,00	---	---	2,26	6,80	8,08	0,40	1,40	2,72	1,81	6,41	12,46	---	---	3,54	5,06	2,74	8,60	11,02
5,0+5,0	3,40	3,40	---	---	2,34	6,80	8,22	0,43	1,38	2,98	1,98	6,32	13,65	---	---	4,30	4,30	2,94	8,60	11,10
5,0+6,0	3,09	3,71	---	---	2,47	6,80	8,45	0,44	1,37	2,92	2,02	6,28	13,36	---	---	3,91	4,69	3,14	8,60	11,10
1,5+1,5+1,5	1,50	1,50	1,50	---	1,96	4,50	6,40	0,39	0,61	1,57	1,77	2,80	7,17	2,17	2,17	2,17	---	2,01	6,50	9,92
1,5+1,5+2,0	1,44	1,44	1,92	---	1,96	4,80	6,56	0,39	0,70	1,65	1,77	3,21	7,54	2,07	2,07	2,76	---	2,01	6,90	10,10
1,5+1,5+2,5	1,42	1,42	2,36	---	1,96	5,20	6,72	0,39	0,83	1,73	1,77	3,81	7,90	2,02	2,02	3,36	---	2,10	7,40	10,18
1,5+1,5+3,5	1,50	1,50	3,50	---	1,96	6,50	7,11	0,38	1,56	1,92	1,73	7,14	8,80	1,89	1,89	4,42	---	2,31	8,20	10,29
1,5+1,5+4,2	1,42	1,42	3,97	---	1,96	6,80	7,33	0,38	1,80	2,05	1,73	8,24	9,37	1,79	1,79	5,02	---	2,31	8,60	10,29
1,5+1,5+5,0	1,28	1,28	4,25	---	1,96	6,80	7,74	0,36	1,75	2,22	1,64	8,01	10,14	1,61	1,61	5,38	---	2,71	8,60	10,46
1,5+1,5+6,0	1,13	1,13	4,53	---	2,31	6,80	7,99	0,40	1,73	2,17	1,85	7,92	9,94	1,43	1,43	5,73	---	2,93	8,60	10,59
1,5+2,0+2,0	1,50	2,00	2,00	---	1,96	5,50	6,48	0,39	1,01	1,61	1,77	4,63	7,38	2,35	3,13	3,13	---	2,01	8,60	10,26
1,5+2,0+2,5	1,50	2,00	2,50	---	1,96	6,00	6,87	0,39	1,32	1,81	1,77	6,05	8,26	2,15	2,87	3,58	---	2,10	8,60	10,36
1,5+2,0+3,5	1,46	1,94	3,40	---	1,96	6,80	7,25	0,38	1,80	2,01	1,73	8,24	9,21	1,84	2,46	4,30	---	2,31	8,60	10,45
1,5+2,0+4,2	1,32	1,77	3,71	---	1,96	6,80	7,47	0,38	1,79	2,14	1,73	8,20	9,78	1,68	2,23	4,69	---	2,31	8,60	10,46
1,5+2,0+5,0	1,20	1,60	4,00	---	1,96	6,80	7,87	0,36	1,74	2,31	1,64	7,97	10,55	1,52	2,02	5,06	---	2,71	8,60	10,88
1,5+2,0+6,0	1,07	1,43	4,29	---	2,31	6,80	8,13	0,40	1,72	2,26	1,85	7,88	10,35	1,36	1,81	5,43	---	2,93	8,60	10,89
1,5+2,5+2,5	1,50	2,50	2,50	---	1,96	6,50	7,10	0,38	1,63	1,92	1,73	7,46	8,80	1,98	3,31	3,31	---	2,20	8,60	10,47
1,5+2,5+3,5	1,36	2,27	3,17	---	1,96	6,80	7,60	0,36	1,79	2,23	1,64	8,20	10,18	1,72	2,87	4,01	---	2,40	8,60	10,58
1,5+2,5+4,2	1,24	2,07	3,48	---	1,96	6,80	7,81	0,36	1,78	2,35	1,64	8,15	10,75	1,57	2,62	4,40	---	2,41	8,60	10,58
1,5+2,5+5,0	1,13	1,89	3,78	---	1,96	6,80	7,95	0,36	1,74	2,35	1,64	7,97	10,75	1,43	2,39	4,78	---	2,81	8,60	11,00
1,5+2,5+6,0	1,02	1,70	4,08	---	2,31	6,80	8,42	0,41	1,71	2,44	1,89	7,83	11,16	1,29	2,15	5,16	---	3,02	8,60	11,00
1,5+3,5+3,5	1,20	2,80	2,80	---	1,96	6,80	7,94	0,37	1,77	2,45	1,68	8,11	11,20	1,52	3,54	3,54	---	2,69	8,60	10,59
1,5+3,5+4,2	1,11	2,59	3,10	---	1,96	6,80	8,13	0,37	1,76	2,58	1,68	8,06	11,81	1,40	3,27	3,93	---	2,69	8,60	10,59
1,5+3,5+5,0	1,02	2,38	3,40	---	1,96	6,80	8,46	0,33	1,72	2,72	1,52	7,88	12,46	1,29	3,01	4,30	---	3,00	8,60	10,93
1,5+3,5+6,0	0,93	2,16	3,71	---	2,31	6,80	8,56	0,41	1,70	2,53	1,89	7,79	11,57	1,17	2,74	4,69	---	2,93	8,60	10,93
1,5+4,2+4,2	1,03	2,88	2,88	---	1,96	6,80	8,26	0,37	1,75	2,68	1,68	8,01	12,26	1,30	---	3,65	3,65	2,69	8,60	10,68
1,5+4,2+5,0	0,95	2,67	3,18	---	1,96	6,80	8,53	0,33	1,71	2,77	1,52	7,83	12,67	1,21	---	3,38	4,02	3,00	8,60	10,99
2,0+2,0+2,0	2,00	2,00	2,00	---	1,96	6,00	6,64	0,39	1,34	1,68	1,77	6,14	7,70	2,60	2,60	2,60	---	2,01	7,80	10,44
2,0+2,0+2,5	2,00	2,00	2,50	---	1,96	6,50	7,03	0,39	1,63	1,89	1,77	7,46	8,64	2,52	2,52	3,15	---	2,10	8,20	10,52
2,0+2,0+3,5	1,81	1,81	3,17	---	1,96	6,80	7,40	0,38	1,79	2,09	1,73	8,20	9,57	2,29	2,29	4,01	---	2,31	8,60	10,63
2,0+2,0+4,2	1,66	1,66	3,48	---	1,96	6,80	7,61	0,38	1,78	2,23	1,73	8,15	10,18	2,10	2,10	4,40	---	2,31	8,60	10,63
2,0+2,0+5,0	1,51	1,51	3,78	---	1,96	6,80	8,01	0,36	1,74	2,39	1,64	7,97	10,96	1,91	1,91	4,78	---	2,71	8,60	10,82
2,0+2,0+6,0	1,36	1,36	4,08	---	2,31	6,80	8,27	0,40	1,71	2,35	1,85	7,83	10,75	1,72	1,72	5,16	---	2,93	8,60	10,95
2,0+2,5+2,5	1,94	2,43																		

Opgenomen vermogen verwarmen [kW]			Totale stroom verwarmen [A]			Vermogens-factor [%]	Seizoensgegevens koelen				Seizoensgegevens verwarmen (gemiddeld klimaat)						Seizoensgegevens verwarmen (warm klimaat)					
Min.	Nom.	Max.	Min.	Nom.	Max.		label	SEER	Ontwerp-capaciteit	AEC	label	SCOP	Ontwerp-capaciteit	AEC	Opgegeven capaciteit bij -10°C	Capaciteit back-upverwarming bij -10°C	label	SCOP	Ontwerp-capaciteit	AEC	Opgegeven capaciteit bij +2°C	Capaciteit back-upverwarming bij +2°C
0,42	0,73	1,22	1,91	3,35	5,58	95	---	---	---	---	---	---	---	---	---	---	---	---	---	---	---	---
0,43	0,74	1,28	1,95	3,39	5,86	95	---	---	---	---	---	---	---	---	---	---	---	---	---	---	---	---
0,42	1,03	1,37	1,91	4,72	6,27	95	---	---	---	---	---	---	---	---	---	---	---	---	---	---	---	---
0,40	1,42	1,75	1,82	6,50	8,01	95	---	---	---	---	---	---	---	---	---	---	---	---	---	---	---	---
0,40	1,41	2,04	1,82	6,46	9,34	95	---	---	---	---	---	---	---	---	---	---	---	---	---	---	---	---
0,39	1,84	2,59	1,78	8,43	11,85	95	---	---	---	---	---	---	---	---	---	---	---	---	---	---	---	---
0,37	2,65	2,64	1,69	12,13	12,08	95	---	---	---	---	---	---	---	---	---	---	---	---	---	---	---	---
0,36	1,19	1,83	1,63	5,45	8,38	95	A++	7,29	3,00	144	A	3,85	3,80	1380	3,07	0,73	A+++	6,08	4,40	1012	4,40	0
0,36	1,31	1,99	1,63	6,00	9,09	95	A++	7,53	3,50	163	A	3,85	3,80	1380	3,08	0,72	A+++	6,10	4,40	1010	4,40	0
0,36	1,43	2,06	1,63	6,55	9,43	95	A++	7,75	4,00	181	A	3,87	3,80	1373	3,09	0,71	A+++	6,11	4,40	1008	4,40	0
0,37	1,69	2,35	1,68	7,74	10,74	95	A++	7,80	5,00	225	A	3,86	4,30	1558	3,39	0,91	A+++	6,13	4,40	1005	4,40	0
0,37	1,90	2,57	1,68	8,70	11,75	95	A++	7,84	5,70	255	A	3,88	4,30	1548	3,40	0,90	A+++	6,14	4,40	1003	4,40	0
0,45	2,13	2,91	2,06	9,75	13,31	95	A++	7,86	6,50	290	A	3,87	4,50	1628	3,55	0,95	A+++	6,17	4,40	998	4,40	0
0,48	2,28	2,67	2,19	10,44	12,21	95	A++	7,81	6,80	305	A	3,91	4,80	1717	3,73	1,07	A+++	6,21	4,40	992	4,40	0
0,36	1,37	2,31	1,63	6,28	10,57	95	A++	7,75	4,00	181	A	3,91	3,80	1361	3,09	0,71	A+++	6,10	4,40	1009	4,40	0
0,36	1,52	2,32	1,63	6,96	10,62	95	A++	7,80	4,50	202	A	3,92	3,80	1354	3,10	0,70	A+++	6,12	4,40	1007	4,40	0
0,37	1,75	2,43	1,68	8,01	11,12	95	A++	7,91	5,50	244	A	3,86	4,30	1558	3,39	0,91	A+++	6,13	4,40	1004	4,40	0
0,37	1,98	2,66	1,68	9,07	12,17	95	A++	7,88	6,20	276	A	3,88	4,30	1550	3,40	0,90	A+++	6,15	4,40	1002	4,40	0
0,45	2,26	3,00	2,06	10,35	13,73	95	A++	7,78	6,80	306	A	3,90	4,50	1612	3,55	0,95	A+++	6,19	4,40	996	4,40	0
0,48	2,24	2,74	2,19	10,26	12,55	95	A++	7,71	6,80	309	A	3,93	4,80	1710	3,73	1,07	A+++	6,22	4,40	990	4,40	0
0,36	1,62	2,36	1,63	7,42	10,78	95	A++	7,81	5,00	224	A	3,85	4,00	1455	3,22	0,78	A+++	6,14	4,40	1004	4,40	0
0,38	1,91	2,66	1,72	8,75	12,17	95	A++	7,94	6,00	265	A	3,83	4,30	1569	3,40	0,90	A+++	6,13	4,40	1004	4,40	0
0,38	2,11	2,82	1,72	9,66	12,93	95	A++	7,99	6,70	294	A	3,86	4,30	1559	3,41	0,89	A+++	6,14	4,40	1003	4,40	0
0,46	2,24	3,09	2,11	10,26	14,15	95	A++	7,93	6,80	300	A	3,84	4,50	1637	3,59	0,91	A+++	6,14	4,40	1003	4,40	0
0,50	2,22	2,77	2,28	10,17	12,67	95	A++	7,90	6,80	301	A	3,91	4,80	1716	3,80	1,00	A+++	6,14	4,40	1002	4,40	0
0,42	2,26	2,86	1,94	10,35	13,09	95	A++	8,02	6,80	297	A+	4,00	4,80	1680	3,73	1,07	A+++	6,14	4,40	1003	4,40	0
0,42	2,26	2,91	1,94	10,35	13,31	95	A++	8,00	6,80	298	A+	4,01	4,80	1675	3,75	1,05	A+++	6,14	4,40	1002	4,40	0
0,51	2,22	3,13	2,32	10,17	14,32	95	A++	7,92	6,80	301	A+	4,01	4,80	1675	3,78	1,02	A+++	6,14	4,40	1003	4,40	0
0,52	2,21	2,76	2,37	10,12	12,63	95	A++	7,89	6,80	302	A+	4,06	4,80	1652	3,79	1,01	A+++	6,14	4,40	1002	4,40	0
0,42	2,22	2,94	1,94	10,17	13,47	95	A++	7,98	6,80	298	A+	4,00	4,80	1679	3,76	1,04	A+++	6,16	4,40	1000	4,40	0
0,51	2,21	3,19	2,32	10,12	14,61	95	A++	7,90	6,80	302	A	3,93	5,20	1851	4,01	1,19	A+++	6,15	4,40	1001	4,40	0
0,51	2,20	2,79	2,32	10,07	12,76	95	A++	7,87	6,80	303	A+	4,03	5,20	1804	4,02	1,18	A+++	6,15	4,40	1002	4,40	0
0,59	2,17	3,11	2,71	9,94	14,23	95	A++	7,88	6,80	302	A+	4,06	5,20	1793	4,05	1,15	A+++	6,14	4,40	1002	4,40	0
0,60	2,15	2,72	2,75	9,84	12,46	95	A++	7,85	6,80	304	A+	4,09	5,20	1779	4,08	1,12	A+++	6,14	4,40	1003	4,40	0
0,41	1,33	2,26	1,89	6,09	10,36	95	A+++	8,54	4,50	185	A+	4,07	5,30	1822	4,19	1,11	A+++	5,65	4,40	1090	4,40	0
0,41	1,46	2,34	1,89	6,69	10,69	95	A+++	8,52	4,80	198	A+	4,08	5,30	1817	4,20	1,10	A+++	5,65	4,40	1089	4,40	0
0,42	1,64	2,37	1,94	7,51	10,86	95	A+++	8,50	5,00	206	A+	4,09	5,30	1810	4,21	1,09	A+++	5,66	4,40	1089	4,40	0
0,44	1,87	2,49	2,02	8,56	11,41	95	A++	7,85	6,50	290	A+	4,14	5,30	1793	4,23	1,07	A+++	5,66	4,40	1087	4,40	0
0,44	2,03	2,49	2,02	9,30	11,41	95	A++	7,71	6,80	309	A+	4,15	5,30	1786	4,24	1,06	A+++	5,67	4,40	1086	4,40	0
0,55	2,01	2,57	2,50	9,20	11,75	95	A++	7,64	6,80	312	A+	4,23	5,30	1752	4,28	1,02	A+++	5,69	4,40	1081	4,40	0
0,55	1,99	2,31	2,50	9,11	10,57	95	A++	7,62	6,80	313	A+	4,27	5,30	1735	4,30	1,00	A+++	5,71	4,40	1079	4,40	0
0,41	2,05	2,41	1,89	9,39	11,03	95	A++	8,17	5,50	236	A+	4,09	5,30	1814	4,21	1,09	A+++	5,66	4,40	1088	4,40	0
0,42	2,04	2,44	1,94	9,34	11,16	95	A++	7,90	6,00	266	A+	4,10	5,30	1807	4,22	1,08	A+++	5,66	4,40	1087	4,40	0
0,44	2,02	2,58	2,02	9,25	11,79	95	A++	7,71	6,80	309	A+	4,14	5,30	1793	4,23	1,07	A+++	5,67	4,40	1085	4,40	0
0,44	2,01	2,57	2,02	9,20	11,75	95	A++	7,69	6,80	310	A+	4,15	5,30	1786	4,24	1,06	A+++	5,68	4,40	1084	4,40	0
0,55	2,00	2,64	2,50	9,16	12,08	95	A++	7,63	6,80	312	A+	4,23	5,30	1752	4,28	1,02	A+++	5,70	4,40	1080	4,40	0
0,55	1,98	2,38	2,50	9,07	10,91	95	A++	7,60	6,80	313	A+	4,27	5,30	1735	4,30	1,00	A+++	5,71	4,40	1077	4,40	0
0,45	2,03	2,44	2,06	9,30	11,16	95	A++	7,76	6,50	294	A+	4,12	5,30	1800	4,22	1,08	A+++	5,67	4,40	1086	4,40	0
0,47	2,02	2,57	2,15	9,25	11,75	95	A++	7,69	6,80	310	A+	4,16	5,30	1782	4,24	1,06	A+++	5,68	4,40	1084	4,40	0
0,47	2,00	2,57	2,15	9,16	11,75	95	A++	7,67	6,80	310	A+	4,19	5,30	1768	4,26	1,04	A+++	5,68	4,40	1084	4,40	0
0,56	1,99	2,64	2,58	9,11	12,08	95	A++	7,61	6,80	313	A+	4,27	5,30	1735	4,30	1,00	A+++	5,71	4,40	1079	4,40	0
0,57	1,97	2,38	2,62	9,02	10,91	95	A++	7,59	6,80	314	A+	4,31	5,30	1719	4,31	0,99	A+++	5,72	4,40	1077	4,40	0
0,55	1,99	2,57	2,50	9,11	11,75	95	A++	7,67	6,80	311	A+	4,20	5,30	1765	4,26	1,04	A+++	5,69	4,40	1082	4,40	0
0,55	1,98	2,56	2,50	9,07	11,71	95	A++	7,65	6,80	311	A+	4,22	5,30	1755	4,27	1,03	A+++	5,69	4,40	1082	4,40	0
0,62	1,97	2,59	2,84	9,02	11,87	95	A++	7,58	6,80	314	A+	4,30	5,30	1722	4,31	0,99	A+++	5,72	4,40	1077	4,40	0
0,55	1,96	2,37	2,50	8,98	10,86	95	A++	7,56	6,80	315	A+	4,34	5,30	1707	4,33	0,97	A+++	5,73	4,40	1075	4,40	0
0,55	1,98	2,59	2,50	9,07	11,87	95	A++	7,63	6,80	312	A+	4,24	5,30	1748	4,28	1,02	A+++	5,71	4,40	1079	4,40	0
0,62	1,96	2,67	2,84	8,98	12,21	95	A++	7,56	6,80	315	A+	4,32	5,30	1716	4,32	0,98	A+++	5,73	4,40	1075	4,40	0
0,41	1,72	2,48	1,89	7,88	11,37	95	A++	7,84	6,00	268	A+	4,07	5,30	1821	4,20	1,10	A+++	5,67	4,40	1086	4,40	0
0,42	1,83	2,52	1,94	8,38	11,54	95	A++	7,76	6,50	294	A+	4,09	5,30	1814	4,21	1,09	A+++	5,68	4,40	1085	4,40	0
0,44	2,04	2,65	2,02	9,34	12,13	95	A++	7,69	6,80	310	A+	4,13	5,30	1796	4,23	1,07	A+++	5,69	4,40	1083	4,40	0
0,44	2,02	2,65	2,02	9,25	12,13	95	A++	7,67	6,80	310	A+	4,14	5,30	1789	4,24	1,06	A+++	5,69	4,40	1082	4,40	0
0,55	2,00	2,72	2,50	9,16	12,46	95	A++	7,61	6,80	313	A+	4,22	5,30	1755	4,27	1,03</						

Combinatietabellen

Binneneunit	Koelcapaciteit [kW]				Totale koelcapaciteit [kW]			Opgenomen vermogen koelen [kW]			Totale stroom koelen [A]			Verwarmingscapaciteit [kW]				Totale verwarmingscapaciteit [kW]		
	Kamer A	Kamer B	Kamer C	Kamer D	Min.	Nom.	Max.	Min.	Nom.	Max.	Min.	Nom.	Max.	Kamer A	Kamer B	Kamer C	Kamer D	Min.	Nom.	Max.
2,0+3,5+5,0	1,30	2,27	3,24	---	2,28	6,80	8,58	0,40	1,69	2,82	1,85	7,74	12,91	1,64	2,87	4,10	---	3,00	8,60	11,11
2,0+4,2+4,2	1,31	2,75	2,75	---	1,96	6,80	8,37	0,37	1,73	2,77	1,68	7,92	12,67	1,65	---	3,47	3,47	2,69	8,60	10,77
2,5+2,5+2,5	2,27	2,27	2,27	---	1,96	6,80	7,53	0,38	1,76	2,18	1,73	8,06	9,98	2,87	2,87	2,87	---	2,31	8,60	10,65
2,5+2,5+3,5	2,00	2,00	2,80	---	1,96	6,80	7,94	0,36	1,72	2,45	1,64	7,88	11,20	2,53	2,53	3,54	---	2,50	8,60	10,87
2,5+2,5+4,2	1,85	1,85	3,10	---	1,96	6,80	8,12	0,36	1,71	2,58	1,64	7,83	11,81	2,34	2,34	3,93	---	2,50	8,60	10,88
2,5+2,5+5,0	1,70	1,70	3,40	---	2,28	6,80	8,45	0,40	1,67	2,72	1,85	7,65	12,46	2,15	2,15	4,30	---	2,91	8,60	11,07
2,5+2,5+6,0	1,55	1,55	3,71	---	2,42	6,80	8,74	0,40	1,65	2,67	1,85	7,56	12,22	1,95	1,95	4,69	---	3,12	8,60	11,08
2,5+3,5+3,5	1,79	2,51	2,51	---	2,27	6,80	8,30	0,40	1,70	2,72	1,85	7,79	12,46	2,26	3,17	3,17	---	2,78	8,60	11,00
2,5+3,5+4,2	1,67	2,33	2,80	---	2,27	6,80	8,43	0,40	1,69	2,82	1,85	7,74	12,91	2,11	2,95	3,54	---	2,79	8,60	11,01
2,5+3,5+5,0	1,55	2,16	3,09	---	2,48	6,80	8,74	0,42	1,65	2,96	1,94	7,56	13,56	1,95	2,74	3,91	---	3,19	8,60	11,08
2,5+4,2+4,2	1,56	2,62	2,62	---	2,27	6,80	8,49	0,40	1,68	2,87	1,85	7,69	13,12	1,97	---	3,31	3,31	2,79	8,60	11,01
3,5+3,5+3,5	2,27	2,27	2,27	---	2,38	6,80	8,59	0,40	1,68	2,96	1,81	7,69	13,56	2,87	2,87	2,87	---	2,98	8,60	11,06
1,5+1,5+1,5+1,5	1,65	1,65	1,65	1,65	1,97	6,60	7,02	0,38	1,38	1,61	1,73	6,32	7,38	1,95	1,95	1,95	1,95	2,47	7,80	10,07
1,5+1,5+1,5+2,0	1,52	1,52	1,52	2,03	1,97	6,60	7,22	0,38	1,37	1,69	1,73	6,28	7,72	1,89	1,89	1,89	2,52	2,47	8,20	10,25
1,5+1,5+1,5+2,5	1,41	1,41	1,41	2,36	1,97	6,60	7,45	0,36	1,35	1,78	1,64	6,18	8,15	1,84	1,84	1,84	3,07	2,57	8,60	10,36
1,5+1,5+1,5+3,5	1,28	1,28	1,28	2,98	1,97	6,80	7,87	0,37	1,58	1,99	1,68	7,24	9,12	1,61	1,61	1,61	3,76	2,77	8,60	10,46
1,5+1,5+1,5+4,2	1,17	1,17	1,17	3,28	1,97	6,80	8,04	0,37	1,58	2,07	1,68	7,24	9,49	1,48	1,48	1,48	4,15	2,78	8,60	10,46
1,5+1,5+1,5+5,0	1,07	1,07	1,07	3,58	2,45	6,80	8,28	0,42	1,54	2,27	1,94	7,05	10,39	1,36	1,36	1,36	4,53	3,10	8,60	10,52
1,5+1,5+1,5+6,0	0,97	0,97	0,97	3,89	2,48	6,80	8,38	0,40	1,52	2,08	1,81	6,96	9,53	1,23	1,23	1,23	4,91	3,04	8,60	10,88
1,5+1,5+2,0+2,0	1,46	1,46	1,94	1,94	1,97	6,80	7,45	0,38	1,60	1,78	1,73	7,33	8,15	1,84	1,84	2,46	2,46	2,47	8,60	10,44
1,5+1,5+2,0+2,5	1,36	1,36	1,81	2,27	1,97	6,80	7,62	0,36	1,58	1,87	1,64	7,24	8,55	1,72	1,72	2,29	2,87	2,57	8,60	10,54
1,5+1,5+2,0+3,5	1,20	1,20	1,60	2,80	1,97	6,80	8,03	0,37	1,57	2,07	1,68	7,19	9,49	1,52	1,52	2,02	3,54	2,77	8,60	10,64
1,5+1,5+2,0+4,2	1,11	1,11	1,48	3,10	1,97	6,80	8,19	0,37	1,56	2,16	1,68	7,14	9,90	1,40	1,40	1,87	3,93	2,78	8,60	10,65
1,5+1,5+2,0+5,0	1,02	1,02	1,36	3,40	2,45	6,80	8,43	0,42	1,53	2,36	1,94	7,01	10,78	1,29	1,29	1,72	4,30	3,10	8,60	10,71
1,5+1,5+2,0+6,0	0,93	0,93	1,24	3,71	2,48	6,80	8,56	0,40	1,51	2,18	1,81	6,92	9,98	1,17	1,17	1,56	4,69	3,04	8,60	11,07
1,5+1,5+2,5+2,5	1,28	1,28	2,13	2,13	1,97	6,80	7,70	0,36	1,58	1,90	1,64	7,24	8,72	1,61	1,61	2,69	2,69	2,67	8,60	10,55
1,5+1,5+2,5+3,5	1,13	1,13	1,89	2,64	2,32	6,80	8,11	0,46	1,56	2,12	2,11	7,14	9,69	1,43	1,43	2,39	3,34	2,98	8,60	10,65
1,5+1,5+2,5+4,2	1,05	1,05	1,75	2,94	2,32	6,80	8,27	0,46	1,55	2,21	2,11	7,10	10,10	1,33	1,33	2,22	3,72	2,98	8,60	10,65
1,5+1,5+2,5+5,0	0,97	0,97	1,62	3,24	2,45	6,80	8,70	0,42	1,52	2,46	1,94	6,96	11,24	1,23	1,23	2,05	4,10	3,10	8,60	10,90
1,5+1,5+3,5+3,5	1,02	1,02	2,38	2,38	2,32	6,80	8,57	0,46	1,55	2,39	2,11	7,10	10,92	1,29	1,29	3,01	3,01	3,18	8,60	10,75
1,5+1,5+3,5+4,2	0,95	0,95	2,22	2,67	2,44	6,80	8,65	0,50	1,54	2,44	2,27	7,05	11,16	1,21	1,21	2,81	3,38	2,99	8,60	10,85
1,5+2,0+2,0+2,0	1,36	1,81	1,81	1,81	1,97	6,80	7,61	0,38	1,59	1,87	1,73	7,28	8,55	1,72	2,29	2,29	2,29	2,47	8,60	10,63
1,5+2,0+2,0+2,5	1,28	1,70	1,70	2,13	1,97	6,80	7,78	0,36	1,58	1,95	1,64	7,24	8,92	1,61	2,15	2,15	2,69	2,57	8,60	10,72
1,5+2,0+2,0+3,5	1,13	1,51	1,51	2,64	2,32	6,80	8,18	0,46	1,57	2,16	2,11	7,19	9,90	1,43	1,91	1,91	3,34	2,77	8,60	10,83
1,5+2,0+2,0+4,2	1,05	1,40	1,40	2,94	2,32	6,80	8,34	0,46	1,56	2,25	2,11	7,14	10,31	1,33	1,77	1,77	3,72	2,78	8,60	10,84
1,5+2,0+2,0+5,0	0,97	1,30	1,30	3,24	2,45	6,80	8,77	0,42	1,53	2,51	1,94	7,01	11,49	1,23	1,64	1,64	4,10	3,10	8,60	10,90
1,5+2,0+2,5+2,5	1,20	1,60	2,00	2,00	1,97	6,80	7,86	0,36	1,58	1,99	1,64	7,24	9,12	1,52	2,02	2,53	2,53	2,67	8,60	10,72
1,5+2,0+2,5+3,5	1,07	1,43	1,79	2,51	2,32	6,80	8,26	0,46	1,56	2,21	2,11	7,14	10,10	1,36	1,81	2,26	3,17	2,98	8,60	10,83
1,5+2,0+2,5+4,2	1,00	1,33	1,67	2,80	2,32	6,80	8,43	0,46	1,55	2,30	2,11	7,10	10,51	1,26	1,69	2,11	3,54	2,98	8,60	10,84
1,5+2,0+2,5+5,0	0,93	1,24	1,55	3,09	2,45	6,80	8,85	0,42	1,52	2,55	1,94	6,96	11,69	1,17	1,56	1,95	3,91	3,10	8,60	11,09
1,5+2,0+3,5+3,5	0,97	1,30	2,27	2,27	1,98	6,80	8,64	0,37	1,55	2,44	1,68	7,10	11,16	1,23	1,64	2,87	2,87	3,18	8,60	10,93
1,5+2,5+2,5+2,5	1,13	1,89	1,89	1,89	1,97	6,80	8,18	0,33	1,57	2,16	1,52	7,19	9,90	1,43	2,39	2,39	2,39	2,77	8,60	10,73
1,5+2,5+2,5+3,5	1,02	1,70	1,70	2,38	2,32	6,80	8,49	0,40	1,55	2,34	1,81	7,10	10,71	1,29	2,15	2,15	3,01	3,08	8,60	10,92
1,5+2,5+2,5+4,2	0,95	1,59	1,59	2,67	2,32	6,80	8,50	0,41	1,55	2,34	1,89	7,10	10,71	1,21	2,01	2,01	3,38	2,98	8,60	11,01
1,5+2,5+3,5+3,5	0,93	1,55	2,16	2,16	2,32	6,80	8,71	0,40	1,54	2,48	1,81	7,05	11,36	1,17	1,95	2,74	2,74	3,18	8,60	11,02
2,0+2,0+2,0+2,0	1,70	1,70	1,70	1,70	1,97	6,80	7,78	0,38	1,58	1,95	1,73	7,24	8,92	2,15	2,15	2,15	2,15	2,47	8,60	10,81
2,0+2,0+2,0+2,5	1,60	1,60	1,60	2,00	1,97	6,80	7,95	0,36	1,58	2,04	1,64	7,24	9,33	2,02	2,02	2,02	2,53	2,57	8,60	10,90
2,0+2,0+2,0+3,5	1,43	1,43	1,43	2,51	1,97	6,80	8,33	0,37	1,56	2,25	1,68	7,14	10,31	1,81	1,81	1,81	3,17	2,77	8,60	11,00
2,0+2,0+2,0+4,2	1,33	1,33	1,33	2,80	1,97	6,80	8,49	0,37	1,55	2,34	1,68	7,10	10,71	1,69	1,69	1,69	3,54	2,78	8,60	11,01
2,0+2,0+2,0+5,0	1,24	1,24	1,24	3,09	2,45	6,80	8,91	0,42	1,52	2,61	1,94	6,96	11,93	1,56	1,56	1,56	3,91	3,10	8,60	11,08
2,0+2,0+2,5+2,5	1,51	1,51	1,89	1,89	1,97	6,80	8,10	0,37	1,57	2,12	1,68	7,19	9,69	1,91	1,91	2,39	2,39	2,67	8,60	10,91
2,0+2,0+2,5+3,5	1,36	1,36	1,70	2,38	2,32	6,80	8,49	0,41	1,55	2,34	1,89	7,10	10,71	1,72	1,72	2,15	3,01	2,98	8,60	11,01
2,0+2,0+2,5+4,2	1,27	1,27	1,59	2,67	2,32	6,80	8,64	0,41	1,55	2,44	1,89	7,10	11,16	1,61	1,61	2,01	3,38	2,98	8,60	11,01
2,0+2,0+3,5+3,5	1,24	1,24	2,16	2,16	2,44	6,80	8,78	0,41	1,55	2,53	1,89	7,10	11,57	1,56	1,56	2,74	2,74	3,18	8,60	11,12
2,0+2,5+2,5+2,5	1,43	1,79	1,79	1,79	1,97	6,80	8,33	0,37	1,56	2,25	1,68	7,14	10,31	1,81	2,26	2,26	2,26	2,77	8,60	10,91
2,0+2,5+2,5+3,5	1,30	1,62	1,62	2,27	2,32	6,80	8,63	0,41	1,55	2,44	1,89	7,10	11,16	1,64	2,05	2,05	2,87	3,08	8,60	11,11
2,5+2,5+2,5+2,5	1,70	1,70	1,70	1,70	2,32	6,80	8,56	0,42	1,55	2,39	1,94	7,10	10,92	2,15	2,15	2,15	2,15	2,88	8,60	11,10
2,5+2,5+2,5+3,5	1,55	1,55	1,55	2,16	2,44	6,80	8,90	0,42	1,54	2,63	1,94	7,05	12,02	1,95	1,95	1,95	2,74	3,18	8,60	11,11

Minimaal 2 binneneunits aansluiten op deze buitenunit. Bovenstaande waarden zijn geldig voor de combinaties met CTXM-R, FTXM-R en FTXA. Voor andere combinaties dient u de energielabel generator te raadplegen.

Opgenomen vermogen verwarmen [kW]			Totale stroom verwarmen [A]			Vermogens-factor [%]	Seizoensgegevens koelen				Seizoensgegevens verwarmen (gemiddeld klimaat)						Seizoensgegevens verwarmen (warm klimaat)					
Min.	Nom.	Max.	Min.	Nom.	Max.		label	SEER	Ontwerp-capaciteit	AEC	label	SCOP	Ontwerp-capaciteit	AEC	Opgegeven capaciteit bij -10°C	Capaciteit back-upverwarming bij -10°C	label	SCOP	Ontwerp-capaciteit	AEC	Opgegeven capaciteit bij +2°C	Capaciteit back-upverwarming bij +2°C
0,58	1,98	2,82	2,67	9,07	12,88	95	A++	7,58	6,80	314	A+	4,28	5,30	1732	4,30	1,00	A+++	5,73	4,40	1074	4,40	0
0,52	1,97	2,69	2,37	9,02	12,29	95	A++	7,63	6,80	312	A+	4,32	5,30	1716	4,32	0,98	A+++	5,69	4,40	1082	4,40	0
0,45	1,99	2,64	2,06	9,11	12,08	95	A++	7,70	6,80	310	A+	4,12	5,30	1800	4,22	1,08	A+++	5,69	4,40	1083	4,40	0
0,48	1,99	2,72	2,19	9,11	12,46	95	A++	7,62	6,80	313	A+	4,16	5,30	1782	4,24	1,06	A+++	5,70	4,40	1081	4,40	0
0,48	1,97	2,72	2,19	9,02	12,46	95	A++	7,60	6,80	313	A+	4,18	5,30	1775	4,25	1,05	A+++	5,70	4,40	1080	4,40	0
0,58	1,96	2,78	2,67	8,98	12,72	95	A++	7,53	6,80	316	A+	4,26	5,30	1742	4,29	1,01	A+++	5,73	4,40	1075	4,40	0
0,58	1,94	2,43	2,67	8,88	11,12	95	A++	7,51	6,80	317	A+	4,30	5,30	1726	4,31	0,99	A+++	5,73	4,40	1074	4,40	0
0,53	1,96	2,72	2,41	8,98	12,46	95	A++	7,59	6,80	314	A+	4,20	5,30	1765	4,26	1,04	A+++	5,71	4,40	1077	4,40	0
0,53	1,96	2,71	2,41	8,98	12,42	95	A++	7,58	6,80	314	A+	4,22	5,30	1758	4,27	1,03	A+++	5,72	4,40	1077	4,40	0
0,60	1,90	2,74	2,75	8,70	12,55	95	A++	7,50	6,80	317	A+	4,30	5,30	1726	4,31	0,99	A+++	5,74	4,40	1073	4,40	0
0,53	1,95	2,71	2,41	8,93	12,42	95	A++	7,56	6,80	315	A+	4,23	5,30	1752	4,28	1,02	A+++	5,72	4,40	1077	4,40	0
0,57	1,94	2,79	2,62	8,88	12,76	95	A++	7,57	6,80	315	A+	4,24	5,30	1748	4,28	1,02	A+++	5,72	4,40	1076	4,40	0
0,49	1,62	2,12	2,24	7,42	9,68	95	A+++	8,54	6,60	271	A+	4,18	5,80	1942	4,65	1,15	A+++	5,75	4,40	1071	4,40	0
0,49	1,77	2,19	2,24	8,11	10,02	95	A+++	8,52	6,60	271	A+	4,19	5,80	1937	4,66	1,14	A+++	5,77	4,40	1067	4,40	0
0,50	1,88	2,20	2,28	8,61	10,07	95	A+++	8,50	6,60	272	A+	4,19	5,80	1934	4,66	1,14	A+++	5,77	4,40	1066	4,40	0
0,54	1,84	2,21	2,45	8,43	10,11	95	A++	8,03	6,80	297	A+	4,24	5,80	1915	4,68	1,12	A+++	5,80	4,40	1061	4,40	0
0,53	1,84	2,20	2,41	8,43	10,06	95	A++	8,01	6,80	297	A+	4,27	5,80	1901	4,68	1,12	A+++	5,81	4,40	1060	4,40	0
0,59	1,83	2,13	2,71	8,38	9,73	95	A++	7,94	6,80	300	A+	4,28	5,80	1896	4,72	1,08	A+++	5,87	4,40	1050	4,40	0
0,45	1,79	1,98	2,06	8,20	9,05	95	A++	7,91	6,80	301	A+	4,38	5,80	1854	4,74	1,06	A+++	5,90	4,40	1044	4,40	0
0,49	1,87	2,26	2,24	8,56	10,36	95	A++	8,06	6,80	296	A+	4,20	5,80	1931	4,67	1,13	A+++	5,79	4,40	1064	4,40	0
0,50	1,87	2,27	2,28	8,56	10,39	95	A++	8,05	6,80	296	A+	4,21	5,80	1926	4,67	1,13	A+++	5,79	4,40	1063	4,40	0
0,54	1,84	2,26	2,45	8,43	10,34	95	A++	8,02	6,80	297	A+	4,28	5,80	1895	4,69	1,11	A+++	5,82	4,40	1058	4,40	0
0,53	1,82	2,25	2,41	8,33	10,30	95	A++	8,01	6,80	298	A+	4,32	5,80	1877	4,70	1,10	A+++	5,84	4,40	1055	4,40	0
0,59	1,82	2,20	2,71	8,33	10,06	95	A++	7,93	6,80	301	A+	4,34	5,80	1871	4,73	1,07	A+++	5,89	4,40	1045	4,40	0
0,45	1,78	2,04	2,06	8,15	9,35	95	A++	7,90	6,80	302	A+	4,44	5,80	1829	4,75	1,05	A+++	5,93	4,40	1039	4,40	0
0,52	1,86	2,23	2,37	8,52	10,19	95	A++	8,03	6,80	297	A+	4,22	5,80	1921	4,68	1,12	A+++	5,79	4,40	1064	4,40	0
0,59	1,82	2,27	2,71	8,33	10,40	95	A++	8,01	6,80	298	A+	4,32	5,80	1878	4,70	1,10	A+++	5,84	4,40	1054	4,40	0
0,58	1,81	2,27	2,67	8,29	10,40	95	A++	7,99	6,80	298	A+	4,34	5,80	1869	4,70	1,10	A+++	5,85	4,40	1053	4,40	0
0,59	1,80	2,25	2,71	8,24	10,30	95	A++	7,91	6,80	301	A+	4,38	5,80	1852	4,74	1,06	A+++	5,91	4,40	1041	4,40	0
0,64	1,78	2,30	2,93	8,15	10,53	95	A++	7,98	6,80	299	A+	4,45	5,80	1822	4,71	1,09	A+++	5,92	4,40	1040	4,40	0
0,58	1,78	2,34	2,67	8,15	10,69	95	A++	7,96	6,80	299	A++	4,60	5,80	1765	4,72	1,08	A+++	5,96	4,40	1033	4,40	0
0,49	1,87	2,34	2,24	8,56	10,69	95	A++	8,04	6,80	296	A+	4,21	5,80	1926	4,67	1,13	A+++	5,79	4,40	1064	4,40	0
0,50	1,86	2,35	2,28	8,52	10,76	95	A++	8,02	6,80	297	A+	4,22	5,80	1921	4,68	1,12	A+++	5,79	4,40	1064	4,40	0
0,54	1,81	2,36	2,45	8,29	10,80	95	A++	8,00	6,80	298	A+	4,32	5,80	1880	4,70	1,10	A+++	5,85	4,40	1053	4,40	0
0,53	1,80	2,35	2,41	8,24	10,74	95	A++	7,98	6,80	299	A+	4,33	5,80	1872	4,71	1,09	A+++	5,85	4,40	1052	4,40	0
0,59	1,79	2,26	2,71	8,20	10,36	95	A++	7,90	6,80	302	A+	4,36	5,80	1859	4,74	1,06	A+++	5,92	4,40	1041	4,40	0
0,52	1,86	2,29	2,37	8,52	10,48	95	A++	8,01	6,80	298	A+	4,23	5,80	1917	4,69	1,11	A+++	5,79	4,40	1063	4,40	0
0,59	1,80	2,35	2,71	8,24	10,74	95	A++	7,98	6,80	299	A+	4,34	5,80	1871	4,70	1,10	A+++	5,85	4,40	1052	4,40	0
0,58	1,80	2,35	2,67	8,24	10,74	95	A++	7,96	6,80	299	A+	4,35	5,80	1864	4,71	1,09	A+++	5,94	4,40	1037	4,40	0
0,59	1,79	2,33	2,71	8,20	10,66	95	A++	7,88	6,80	302	A+	4,38	5,80	1854	4,75	1,05	A+++	5,92	4,40	1041	4,40	0
0,64	1,78	2,37	2,93	8,15	10,86	95	A++	7,95	6,80	300	A++	4,62	5,80	1757	4,72	1,08	A+++	5,95	4,40	1034	4,40	0
0,55	1,85	2,29	2,50	8,47	10,48	95	A++	7,99	6,80	298	A+	4,24	5,80	1912	4,70	1,10	A+++	5,79	4,40	1063	4,40	0
0,62	1,79	2,38	2,84	8,20	10,91	95	A++	7,96	6,80	299	A+	4,37	5,80	1858	4,71	1,09	A+++	5,95	4,40	1036	4,40	0
0,58	1,78	2,41	2,67	8,15	11,03	95	A++	7,94	6,80	300	A+	4,39	5,80	1848	4,72	1,08	A+++	5,95	4,40	1035	4,40	0
0,64	1,76	2,41	2,93	8,06	11,03	95	A++	7,93	6,80	300	A++	4,63	5,80	1751	4,73	1,07	A+++	5,98	4,40	1031	4,40	0
0,49	1,86	2,40	2,24	8,52	10,99	95	A++	8,03	6,80	297	A+	4,22	5,80	1921	4,68	1,12	A+++	5,79	4,40	1064	4,40	0
0,50	1,86	2,41	2,28	8,52	11,03	95	A++	8,01	6,80	297	A+	4,23	5,80	1917	4,69	1,11	A+++	5,79	4,40	1063	4,40	0
0,54	1,79	2,42	2,45	8,20	11,07	95	A++	7,98	6,80	298	A+	4,38	5,80	1853	4,70	1,10	A+++	5,88	4,40	1047	4,40	0
0,53	1,80	2,42	2,41	8,24	11,07	95	A++	7,97	6,80	299	A+	4,40	5,80	1846	4,71	1,09	A+++	5,94	4,40	1036	4,40	0
0,59	1,78	2,34	2,71	8,15	10,69	95	A++	7,88	6,80	302	A+	4,42	5,80	1836	4,75	1,05	A+++	5,92	4,40	1040	4,40	0
0,52	1,85	2,36	2,37	8,47	10,82	95	A++	7,99	6,80	298	A+	4,24	5,80	1912	4,70	1,10	A+++	5,79	4,40	1063	4,40	0
0,56	1,78	2,42	2,58	8,15	11,07	95	A++	7,97	6,80	299	A+	4,39	5,80	1850	4,71	1,09	A+++	5,96	4,40	1034	4,40	0
0,56	1,78	2,42	2,58	8,15	11,07	95	A++	7,95	6,80	300	A+	4,40	5,80	1842	4,72	1,08	A+++	5,96	4,40	1033	4,40	0
0,61	1,76	2,45	2,80	8,06	11,20	95	A++	7,95	6,80	300	A++	4,65	5,80	1745	4,73	1,07	A+++	5,98	4,40	1030	4,40	0
0,54	1,84	2,36	2,45	8,43	10,82	95	A++	7,97	6,80	299	A+	4,26	5,80	1905	4,71	1,09	A+++	5,80	4,40	1062	4,40	0
0,59	1,78	2,46	2,71	8,15	11,24	95	A++	7,95	6,80	300	A+	4,39	5,80	1846	4,72	1,08	A+++	5,95	4,40	1034	4,40	0
0,54	1,84	2,38	2,45	8,43	10,91	95	A++	7,96	6,80	299	A+	4,27	5,80	1900	4,71	1,09	A+++	5,88	4,40	1047	4,40	0
0,60	1,79	2,37	2,75	8,20	10,86	95	A++	7,93	6,80	300	A+	4,42	5,80	1835	4,73	1,07	A+++	5,94	4,40	1037	4,40	0

Combinatietabellen

Binneneunit	Koelcapaciteit [kW]				Totale koelcapaciteit [kW]			Opgenomen vermogen koelen [kW]			Totale stroom koelen [A]			Verwarmingscapaciteit [kW]				Totale verwarmingscapaciteit [kW]		
	Kamer A	Kamer B	Kamer C	Kamer D	Min.	Nom.	Max.	Min.	Nom.	Max.	Min.	Nom.	Max.	Kamer A	Kamer B	Kamer C	Kamer D	Min.	Nom.	Max.
1,5	1,80	---	---	---	1,73	1,80	2,96	0,42	0,34	0,58	1,88	---	---	---	1,25	1,88	4,10	0,29	0,51	1,23
2,0	2,00	---	---	---	1,78	2,00	3,08	0,45	0,38	0,62	2,46	---	---	---	1,28	2,46	4,26	0,30	0,66	1,29
2,5	2,50	---	---	---	1,85	2,50	3,65	0,48	0,48	0,81	3,08	---	---	---	1,33	3,08	4,73	0,32	0,86	1,38
3,5	3,50	---	---	---	1,95	3,50	4,90	0,49	0,76	1,33	4,31	---	---	---	1,45	4,31	5,31	0,33	1,39	1,68
4,2	4,20	---	---	---	1,98	4,20	5,33	0,49	1,01	1,47	---	5,18	---	---	1,49	5,18	6,16	0,34	1,63	1,90
5,0	5,00	---	---	---	2,05	5,00	6,03	0,46	1,30	1,74	---	6,15	---	---	1,86	6,15	7,40	0,43	1,74	2,77
6,0	6,00	---	---	---	2,15	6,00	6,80	0,46	1,77	2,28	---	7,38	---	---	2,15	7,38	9,00	0,53	2,15	3,11
7,1	7,10	---	---	---	2,26	7,10	7,45	0,49	2,53	2,83	---	8,74	---	---	2,45	8,74	9,36	0,57	2,71	3,45
1,5+1,5	1,50	1,50	---	---	1,98	3,00	4,79	0,45	0,56	1,02	1,85	1,85	---	---	1,45	3,70	7,43	0,41	0,86	1,84
1,5+2,0	1,50	2,00	---	---	2,01	3,50	4,96	0,49	0,69	1,11	1,84	2,46	---	---	1,51	4,30	7,81	0,41	1,01	2,00
1,5+2,5	1,50	2,50	---	---	2,03	4,00	5,28	0,44	0,83	1,25	1,84	3,06	---	---	1,65	4,90	8,00	0,45	1,17	2,07
1,5+3,5	1,50	3,50	---	---	2,05	5,00	6,17	0,42	1,16	1,59	1,83	4,27	---	---	1,94	6,10	8,55	0,52	1,64	2,36
1,5+4,2	1,50	4,20	---	---	2,12	5,70	6,52	0,46	1,43	1,79	1,84	5,16	---	---	2,14	7,00	8,90	0,55	1,94	2,58
1,5+5,0	1,50	5,00	---	---	2,20	6,50	7,12	0,47	1,70	2,01	1,85	6,15	---	---	2,38	8,00	10,43	0,50	2,11	2,92
1,5+6,0	1,48	5,92	---	---	2,32	7,40	7,77	0,51	2,16	2,38	1,80	7,20	---	---	2,66	9,00	10,63	0,52	2,30	2,68
1,5+7,1	1,40	6,60	---	---	2,47	8,00	8,43	0,54	2,45	2,81	1,67	7,93	---	---	2,96	9,60	10,65	0,55	2,47	2,42
2,0+2,0	2,00	2,00	---	---	1,95	4,00	5,41	0,46	0,84	1,34	2,45	2,45	---	---	1,65	4,90	8,00	0,32	1,16	2,32
2,0+2,5	2,00	2,50	---	---	2,00	4,50	5,85	0,46	0,99	1,50	2,44	3,06	---	---	1,80	5,50	8,17	0,35	1,34	2,33
2,0+3,5	2,00	3,50	---	---	2,10	5,50	6,51	0,46	1,35	1,79	2,44	4,26	---	---	2,09	6,70	8,72	0,40	1,70	2,44
2,0+4,2	2,00	4,20	---	---	2,17	6,20	6,91	0,46	1,64	2,00	2,45	5,15	---	---	2,28	7,60	9,08	0,44	1,98	2,67
2,0+5,0	2,00	5,00	---	---	2,25	7,00	7,45	0,47	1,95	2,21	2,43	6,07	---	---	2,52	8,50	10,61	0,52	2,28	3,01
2,0+6,0	1,85	5,55	---	---	2,39	7,40	8,08	0,51	2,16	2,57	2,33	6,98	---	---	2,79	9,30	10,80	0,54	2,42	2,75
2,0+7,1	1,76	6,24	---	---	2,53	8,00	8,65	0,54	2,45	3,00	2,11	7,49	---	---	3,10	9,60	10,90	0,57	2,47	2,66
2,5+2,5	2,50	2,50	---	---	2,05	5,00	6,28	0,42	1,17	1,69	3,05	3,05	---	---	1,94	6,10	8,54	0,39	1,68	2,37
2,5+3,5	2,50	3,50	---	---	2,15	6,00	6,75	0,46	1,55	1,93	3,04	4,26	---	---	2,23	7,30	9,10	0,52	2,02	2,67
2,5+4,2	2,50	4,20	---	---	2,22	6,70	7,23	0,46	1,89	2,20	3,06	5,14	---	---	2,44	8,20	9,37	0,54	2,28	2,83
2,5+5,0	2,47	4,93	---	---	2,32	7,40	7,80	0,50	2,16	2,39	3,00	6,00	---	---	2,66	9,00	10,70	0,54	2,51	3,10
2,5+6,0	2,35	5,65	---	---	2,46	8,00	8,35	0,54	2,45	2,75	2,82	6,78	---	---	2,94	9,60	10,90	0,55	2,63	2,78
2,5+7,1	2,08	5,92	---	---	2,60	8,00	8,65	0,54	2,45	3,10	2,50	7,10	---	---	3,23	9,60	10,90	0,59	2,50	2,70
3,5+3,5	3,50	3,50	---	---	2,25	7,00	7,45	0,46	2,04	2,31	4,25	4,25	---	---	2,52	8,50	9,55	0,55	2,47	2,87
3,5+4,2	3,50	4,20	---	---	2,35	7,70	7,81	0,50	2,47	2,57	4,09	4,91	---	---	2,71	9,00	10,16	0,57	2,69	3,19
3,5+5,0	3,29	4,71	---	---	2,46	8,00	7,98	0,53	2,45	2,63	3,91	5,59	---	---	2,94	9,50	10,92	0,58	2,66	3,14
3,5+6,0	2,95	5,05	---	---	2,58	8,00	8,61	0,54	2,49	3,04	3,54	6,06	---	---	3,21	9,60	11,03	0,57	2,48	2,77
3,5+7,1	2,64	5,36	---	---	2,74	8,00	8,64	0,58	2,46	2,86	3,17	6,43	---	---	3,52	9,60	11,05	0,63	2,42	2,61
4,2+4,2	4,00	4,00	---	---	2,44	8,00	7,82	0,53	2,66	2,74	4,75	4,75	---	---	2,91	9,50	9,98	0,59	2,55	2,95
4,2+5,0	3,65	4,35	---	---	2,54	8,00	8,17	0,53	2,45	2,82	4,38	5,22	---	---	3,13	9,60	10,93	0,60	2,59	3,20
4,2+6,0	3,29	4,71	---	---	2,68	8,00	8,63	0,58	2,49	3,15	3,95	5,65	---	---	3,41	9,60	11,05	0,61	2,39	2,80
4,2+7,1	2,97	5,03	---	---	2,83	8,00	8,81	0,62	2,46	3,38	3,57	6,03	---	---	3,70	9,60	11,07	0,66	2,38	2,60
5,0+5,0	4,00	4,00	---	---	2,65	8,00	8,33	0,57	2,39	2,78	4,80	4,80	---	---	3,35	9,60	11,10	0,63	2,46	3,12
5,0+6,0	3,64	4,36	---	---	2,79	8,00	8,81	0,62	2,35	3,15	4,36	5,24	---	---	3,62	9,60	11,12	0,62	2,35	2,73
5,0+7,1	3,31	4,69	---	---	2,94	8,00	9,08	0,62	2,35	3,32	3,97	5,63	---	---	3,93	9,60	11,14	0,66	2,33	2,57
6,0+6,0	4,00	4,00	---	---	2,93	8,00	9,42	0,62	2,35	3,49	4,80	4,80	---	---	3,90	9,60	11,14	0,63	2,27	2,55
6,0+7,1	3,66	4,34	---	---	3,22	8,00	9,44	0,58	2,34	3,57	4,40	5,20	---	---	4,20	9,60	11,16	0,67	2,26	2,54
7,1+7,1	4,00	4,00	---	---	3,38	8,00	9,47	0,61	2,30	3,57	4,80	4,80	---	---	4,51	9,60	11,20	0,73	2,20	2,48
1,5+1,5+1,5	1,50	1,50	1,50	---	2,00	4,50	6,40	0,44	0,90	1,41	1,83	1,83	1,83	---	1,80	5,50	9,95	0,40	1,14	2,27
1,5+1,5+2,0	1,50	1,50	2,00	---	2,05	5,00	6,56	0,48	1,04	1,50	1,83	1,83	2,44	---	1,94	6,10	10,13	0,41	1,32	2,35
1,5+1,5+2,5	1,50	1,50	2,50	---	2,10	5,50	6,72	0,48	1,21	1,59	1,83	1,83	3,05	---	2,09	6,70	10,21	0,43	1,49	2,38
1,5+1,5+3,5	1,50	1,50	3,50	---	2,20	6,50	7,13	0,48	1,55	1,82	1,85	1,85	4,31	---	2,38	8,00	10,32	0,47	1,88	2,50
1,5+1,5+4,2	1,50	1,50	4,20	---	2,28	7,20	7,60	0,48	1,86	2,03	1,81	1,81	5,08	---	2,58	8,70	10,32	0,49	2,15	2,50
1,5+1,5+5,0	1,39	1,39	4,63	---	2,39	7,40	8,10	0,52	1,87	2,21	1,74	1,74	5,81	---	2,79	9,30	10,49	0,50	2,21	2,58
1,5+1,5+6,0	1,33	1,33	5,33	---	2,52	8,00	8,55	0,55	2,15	2,45	1,58	1,58	6,33	---	3,07	9,50	11,14	0,51	2,20	2,50
1,5+1,5+7,1	1,19	1,19	5,62	---	2,67	8,00	9,07	0,59	2,15	2,76	1,43	1,43	6,75	---	3,38	9,60	11,17	0,54	2,21	2,49
1,5+2,0+2,0	1,50	2,00	2,00	---	2,10	5,50	6,54	0,48	1,21	1,55	1,83	2,44	2,44	---	2,09	6,70	10,29	0,43	1,49	2,42
1,5+2,0+2,5	1,50	2,00	2,50	---	2,15	6,00	6,89	0,48	1,39	1,70	1,83	2,43	3,04	---	2,23	7,30	10,39	0,45	1,68	2,45
1,5+2,0+3,5	1,50	2,00	3,50	---	2,25	7,00	7,47	0,48	1,76	1,98	1,82	2,43	4,25	---	2,52	8,50	10,48	0,49	2,06	2,59
1,5+2,0+4,2	1,50	2,00	4,20	---	2,35	7,70	7,92	0,51	2,09	2,20	1,75	2,34	4,91	---	2,71	9,00	10,49	0,51	2,22	2,58
1,5+2,0+5,0	1,41	1,88	4,71	---	2,46	8,00	8,31	0,54	2,18	2,33	1,69	2,26	5,65	---	2,94	9,60	10,91	0,52	2,34	2,65
1,5+2,0+6,0	1,26	1,68	5,05	---	2,58	8,00	8,86	0,55	2,15	2,63	1,52	2,02	6,06	---	3,21	9,60	11,14	0,53	2,22	2,50
1,5+2,0+7,1	1,13	1,51	5,36	---	2,74	8,00	9,26	0,59	2,15	2,89	1,36	1,81	6,43	---	3,52	9,60	11,17	0,56	2,21	2,49
1,5+2,5+2,5	1,50	2,50	2,50	---	2,20	6,50	7,11	0,48	1,56	1,82	1,85	3,08	3,08	---	2,38	8,00	10,50	0,47	1,95	2,45
1,5+2,5+3,5	1,48	2,47	3,45	---	2,32	7,40	7,82	0,51	1,95	2,14	1,80	3,00	4,20	---	2,66	9,00	10,61	0,51	2,22	2,58
1,5+2,5+4,2	1,46	2,44	4,10	---	2,42	8,00	8,25	0,51	2,25	2,37	1,76	2,93	4,92	---	2,86	9,60	10,61	0,53	2,42	2,58
1,5+2,5+5,0	1,33	2,22	4,44	---	2,52	8,00	8,64	0,54	2,18	2,51	1,60	2,67	5,33	---	3,07	9,60	11,03	0,54	2,34	2,65
1,5+2,5+6,0	1,20	2,00	4,80	---	2,65	8,00	9,07	0,55	2,15	2,76	1,44	2,40	5,76	---	3,35	9,60	11,14	0,55	2,22	2,50
1,5+2,5+7,1	1,08	1,80	5,12	---	2,80	8,00	9,37	0,59	2,15	2,95	1,30	2,16	6,14	---	3,65	9,60	11,17	0,58	2,21	2,49
1,5																				

Opgenomen vermogen verwarmen [kW]			Totale stroom verwarmen [A]			Vermogensfactor [%]	Seizoensgegevens koelen				Seizoensgegevens verwarmen (gemiddeld klimaat)						Seizoensgegevens verwarmen (warm klimaat)					
Min.	Nom.	Max.	Min.	Nom.	Max.		label	SEER	Ontwerp-capaciteit	AEC	label	SCOP	Ontwerp-capaciteit	AEC	Opgegeven capaciteit bij -10°C	Capaciteit back-upverwarming bij -10°C	label	SCOP	Ontwerp-capaciteit	AEC	Opgegeven capaciteit bij +2°C	Capaciteit back-upverwarming bij +2°C
1,33	2,34	5,63	1,91	1,60	2,70	95	---	---	---	---	---	---	---	---	---	---	---	---	---	---	---	---
1,38	3,01	5,90	2,04	1,80	2,90	95	---	---	---	---	---	---	---	---	---	---	---	---	---	---	---	---
1,46	3,95	6,32	2,18	2,20	3,80	95	---	---	---	---	---	---	---	---	---	---	---	---	---	---	---	---
1,51	6,37	7,68	2,24	3,50	6,10	95	---	---	---	---	---	---	---	---	---	---	---	---	---	---	---	---
1,55	7,45	8,70	2,26	4,70	6,72	95	---	---	---	---	---	---	---	---	---	---	---	---	---	---	---	---
1,95	7,99	12,68	2,09	6,00	7,97	95	---	---	---	---	---	---	---	---	---	---	---	---	---	---	---	---
2,44	9,83	14,23	2,09	8,10	10,43	95	---	---	---	---	---	---	---	---	---	---	---	---	---	---	---	---
2,62	12,43	15,79	2,22	11,60	13,00	95	---	---	---	---	---	---	---	---	---	---	---	---	---	---	---	---
1,89	3,94	8,42	2,05	2,60	4,65	95	A++	6,96	3,00	151	A	3,88	3,27	1180	3,05	0,22	A+++	5,49	3,90	994	3,90	0
1,89	4,63	9,15	2,24	3,20	5,10	95	A++	7,09	3,50	173	A	3,88	3,27	1178	3,06	0,21	A+++	5,49	3,90	994	3,90	0
2,06	5,36	9,47	2,02	3,90	5,72	95	A++	7,18	4,00	195	A	3,89	3,27	1176	3,06	0,21	A+++	5,49	3,90	993	3,90	0
2,37	7,51	10,80	1,94	5,40	7,29	95	A++	7,33	5,00	239	A	3,92	3,57	1275	3,24	0,33	A+++	5,49	3,90	994	3,90	0
2,54	8,88	11,81	2,11	6,60	8,30	95	A++	7,34	5,70	272	A	3,92	3,57	1273	3,25	0,32	A+++	5,49	4,00	1019	4,00	0
2,28	9,66	13,36	2,15	7,80	9,20	95	A++	7,41	6,50	307	A+	4,01	4,27	1489	3,64	0,63	A+++	5,51	4,00	1016	4,00	0
2,37	10,53	12,27	2,32	9,90	10,90	95	A++	7,36	7,40	352	A+	4,03	4,27	1483	3,66	0,61	A+++	5,51	4,10	1042	4,10	0
2,50	11,31	11,56	2,48	11,30	13,00	95	A++	7,35	8,60	410	A+	4,04	4,27	1477	3,68	0,59	A+++	5,50	4,10	1042	4,10	0
1,46	5,31	10,62	2,11	3,90	6,12	95	A++	7,18	4,00	195	A	3,87	3,27	1183	3,06	0,21	A+++	5,49	3,90	994	3,90	0
1,59	6,14	10,66	2,11	4,60	7,00	95	A++	7,23	4,50	218	A	3,87	3,27	1181	3,06	0,21	A+++	5,50	3,90	993	3,90	0
1,85	7,79	11,17	2,11	6,20	8,30	95	A++	7,38	5,50	261	A	3,93	3,57	1271	3,25	0,32	A+++	5,49	4,00	1019	4,00	0
2,02	9,07	12,22	2,11	7,60	9,20	95	A++	7,39	6,20	294	A	3,93	3,57	1269	3,25	0,32	A+++	5,50	4,00	1019	4,00	0
2,37	10,44	13,78	2,15	9,00	10,11	95	A++	7,43	7,00	330	A+	4,04	4,27	1479	3,65	0,62	A+++	5,50	4,00	1017	4,00	0
2,45	11,08	12,59	2,32	9,90	11,80	95	A++	7,38	7,40	351	A+	4,05	4,27	1474	3,67	0,60	A+++	5,50	4,10	1043	4,10	0
2,62	11,31	12,17	2,48	11,30	13,80	95	A++	7,40	8,00	379	A+	4,07	4,27	1468	3,68	0,59	A+++	5,50	4,20	1068	4,20	0
1,76	7,69	10,85	1,94	5,40	7,80	95	A++	7,34	5,00	239	A	3,88	3,27	1179	3,07	0,20	A+++	5,50	3,90	993	3,90	0
2,37	9,25	12,22	2,11	7,10	8,82	95	A++	7,39	6,00	285	A	3,94	3,57	1268	3,25	0,32	A+++	5,51	4,00	1017	4,00	0
2,45	10,44	12,95	2,11	8,70	10,05	95	A++	7,45	6,70	315	A	3,95	3,57	1266	3,25	0,32	A+++	5,51	4,00	1016	4,00	0
2,45	11,49	14,19	2,27	9,90	11,00	95	A++	7,36	7,40	352	A+	4,07	4,27	1468	3,65	0,62	A+++	5,52	4,00	1015	4,00	0
2,54	12,04	12,72	2,48	11,30	12,60	95	A++	7,40	8,00	379	A+	4,08	4,27	1463	3,67	0,60	A+++	5,51	4,10	1040	4,10	0
2,71	11,45	12,36	2,48	11,30	14,19	95	A++	7,39	8,50	403	A+	4,10	4,27	1457	3,69	0,58	A+++	5,51	4,20	1066	4,20	0
2,54	11,31	13,14	2,11	9,40	10,57	95	A++	7,43	7,00	330	A+	4,04	4,27	1478	3,64	0,63	A+++	5,51	4,00	1015	4,00	0
2,62	12,32	15,25	2,27	11,40	11,76	95	A++	7,40	7,70	365	A+	4,05	4,27	1475	3,64	0,63	A+++	5,51	4,00	1015	4,00	0
2,67	12,18	14,37	2,44	11,30	12,02	95	A++	7,37	8,00	380	A+	4,04	4,97	1720	4,04	0,93	A+++	5,57	4,00	1005	4,00	0
2,62	11,36	12,68	2,48	11,50	13,91	95	A++	7,38	8,00	380	A+	4,06	4,97	1714	4,06	0,91	A+++	5,57	4,10	1031	4,10	0
2,88	11,08	11,95	2,65	11,30	13,09	95	A++	7,27	9,00	434	A+	4,07	4,97	1707	4,08	0,89	A+++	5,57	4,20	1056	4,20	0
2,71	11,68	11,82	2,44	12,20	12,52	95	A++	7,38	8,40	399	A+	4,06	4,27	1472	3,65	0,62	A+++	5,52	4,00	1015	4,00	0
2,75	11,86	14,65	2,44	11,20	12,91	95	A++	7,32	8,00	383	A+	4,11	4,97	1693	4,05	0,92	A+++	5,57	4,10	1030	4,10	0
2,80	10,94	12,81	2,65	11,50	14,44	95	A++	7,29	8,50	408	A+	4,12	4,97	1686	4,06	0,91	A+++	5,57	4,10	1031	4,10	0
3,01	10,90	11,90	2,82	11,30	15,45	95	A++	7,27	9,00	434	A+	4,14	4,97	1680	4,08	0,89	A+++	5,57	4,20	1056	4,20	0
2,88	11,26	14,28	2,61	11,00	12,70	95	A++	7,40	8,50	402	A+	4,00	6,23	2177	4,75	1,48	A+++	5,64	4,10	1018	4,10	0
2,84	10,76	12,49	2,82	10,80	14,42	95	A++	7,44	9,00	423	A+	4,02	6,23	2168	4,76	1,47	A+++	5,64	4,10	1018	4,10	0
3,01	10,67	11,76	2,82	10,80	15,21	95	A++	7,45	9,00	423	A+	4,03	6,23	2160	4,78	1,45	A+++	5,63	4,20	1043	4,20	0
2,88	10,39	11,67	2,82	10,80	15,99	95	A++	7,45	9,00	423	A+	4,03	6,23	2164	4,77	1,46	A+++	5,64	4,20	1043	4,20	0
3,05	10,35	11,62	2,70	10,70	16,34	95	A++	7,45	9,00	423	A+	4,04	6,23	2155	4,79	1,44	A+++	5,63	4,20	1043	4,20	0
3,36	10,07	11,86	2,90	10,60	16,36	95	A++	7,45	9,00	423	A+	4,04	6,23	2156	4,80	1,43	A+++	5,63	4,30	1069	4,30	0
1,85	5,22	10,39	2,02	4,20	6,44	95	A++	7,93	4,50	199	A	3,92	4,57	1631	3,85	0,72	A+++	5,87	3,60	858	3,60	0
1,89	6,05	10,76	2,19	4,80	6,86	95	A++	8,00	5,00	219	A	3,93	4,57	1626	3,85	0,72	A+++	5,86	3,70	883	3,70	0
1,98	6,82	10,89	2,19	5,60	7,29	95	A++	8,23	5,50	234	A	3,94	4,57	1621	3,85	0,72	A+++	5,85	3,70	885	3,70	0
2,15	8,61	11,44	2,19	7,20	8,40	95	A++	8,25	6,50	276	A	3,94	5,27	1871	4,26	1,01	A+++	5,88	3,80	905	3,80	0
2,24	9,84	11,44	2,19	8,50	9,40	95	A++	8,22	7,20	307	A	3,95	5,27	1865	4,26	1,01	A+++	5,86	3,80	907	3,80	0
2,28	10,12	11,81	2,36	8,60	10,20	95	A++	8,14	7,40	318	A+	4,04	6,23	2155	4,80	1,43	A+++	5,85	3,90	934	3,90	0
2,32	10,07	11,95	2,53	9,90	11,30	95	A++	8,09	8,00	346	A+	4,08	6,23	2138	4,82	1,41	A+++	5,80	4,00	964	4,00	0
2,45	10,12	11,91	2,69	9,90	12,70	95	A++	8,04	8,50	370	A+	4,11	6,23	2122	4,84	1,39	A+++	5,76	4,10	996	4,10	0
1,98	6,82	11,08	2,19	5,60	7,11	95	A++	8,21	5,50	235	A	3,93	4,57	1624	3,85	0,72	A+++	5,85	3,60	862	3,60	0
2,06	7,69	11,21	2,19	6,40	7,77	95	A++	8,20	6,00	256	A	3,96	4,57	1615	3,86	0,71	A+++	5,84	3,60	863	3,60	0
2,24	9,43	11,85	2,19	8,10	9,10	95	A++	8,23	7,00	298	A	3,94	5,27	1869	4,26	1,01	A+++	5,86	3,60	859	3,60	0
2,32	10,17	11,81	2,32	9,60	10,10	95	A++	8,16	7,70	331	A	3,96	5,27	1863	4,26	1,01	A+++	5,85	3,70	885	3,70	0
2,37	10,71	12,13	2,48	10,00	10,70	95	A++	8,08	8,00	347	A+	4,05	6,23	2153	4,81	1,42	A+++	5,83	3,80	912	3,80	0
2,41	10,17	11,95	2,53	9,90	12,10	95	A++	8,07	8,00	347	A+	4,08	6,23	2136	4,82	1,41	A+++	5,79	3,90	943	3,90	0
2,58	10,12	11,91	2,69	9,90	13,30	95	A++	7,98	9,00	395	A+	4,11	6,23	2120	4,84	1,39	A+++	5,75	4,00	974	4,00	0
2,15	8,93	11,21	2,19	7,20	8,40	95	A++	8,21	6,50	278	A	3,97	4,57	1610	3,86	0,71	A+++	5,87	3,60	859	3,60	0
2,32	10,17	11,81	2,32	9,00	9,90	95	A++	8,19	7,40	317	A	3,97	5,27	1858	4,26	1,01	A+++	5,89	3,70	879	3,70	0
2,41	11,08	11,81	2,32	10,30	10,90	95	A++	8,07	8,20	356	A	3,98	5,27	1852	4,27	1,00	A+++	5,88	3,70	881	3,70	0
2,45	10,71	12,13	2,48	10,00	11,50	95	A++	8,08	8,00	347	A+	4,07	6,23	2140	4,81							

Combinatietabellen

Binneneunit	Koelcapaciteit [kW]				Totale koelcapaciteit [kW]			Opgenomen vermogen koelen [kW]			Totale stroom koelen [A]			Verwarmingscapaciteit [kW]				Totale verwarmingscapaciteit [kW]		
	Kamer A	Kamer B	Kamer C	Kamer D	Min.	Nom.	Max.	Min.	Nom.	Max.	Min.	Nom.	Max.	Kamer A	Kamer B	Kamer C	Kamer D	Min.	Nom.	Max.
1,5+4,2+5,0	1,12	3,14	3,74	---	2,75	8,00	8,84	0,58	2,14	2,75	1,35	3,77	4,49	---	3,54	9,60	11,02	0,62	2,34	2,68
1,5+4,2+6,0	1,03	2,87	4,10	---	2,89	8,00	9,47	0,62	2,14	3,01	1,23	3,45	4,92	---	3,81	9,60	11,27	0,60	2,22	2,80
1,5+4,2+7,1	0,94	2,63	4,44	---	3,04	8,00	9,49	0,65	2,14	3,09	1,13	3,15	5,33	---	4,12	9,60	11,30	0,67	2,21	2,78
1,5+5,0+5,0	1,04	3,48	3,48	---	2,86	8,00	9,23	0,62	2,09	2,83	1,25	4,17	4,17	---	3,76	9,60	11,17	0,62	2,25	2,83
1,5+5,0+6,0	0,96	3,20	3,84	---	3,00	8,00	9,66	0,63	2,08	3,03	1,15	3,84	4,61	---	4,04	9,60	11,41	0,63	2,14	2,75
1,5+5,0+7,1	0,88	2,94	4,18	---	3,32	8,00	9,68	0,58	2,08	3,07	1,06	3,53	5,01	---	4,35	9,60	11,44	0,67	2,13	2,73
1,5+6,0+6,0	0,89	3,56	3,56	---	3,13	8,00	9,83	0,66	2,05	3,11	1,07	4,27	4,27	---	4,31	9,60	11,65	0,64	2,07	2,67
2,0+2,0+2,0	2,00	2,00	2,00	---	2,15	6,00	6,76	0,48	1,39	1,69	2,50	2,50	2,50	---	2,23	7,50	10,47	0,45	1,73	2,49
2,0+2,0+2,5	2,00	2,00	2,50	---	2,20	6,50	7,10	0,48	1,58	1,82	2,46	2,46	3,08	---	2,38	8,00	10,55	0,47	1,87	2,53
2,0+2,0+3,5	1,97	1,97	3,45	---	2,32	7,40	7,80	0,51	1,96	2,14	2,40	2,40	4,20	---	2,66	9,00	10,66	0,51	2,21	2,66
2,0+2,0+4,2	1,95	1,95	4,10	---	2,42	8,00	8,23	0,51	2,25	2,37	2,29	2,29	4,81	---	2,86	9,40	10,66	0,53	2,41	2,66
2,0+2,0+5,0	1,78	1,78	4,44	---	2,52	8,00	8,63	0,54	2,18	2,51	2,13	2,13	5,33	---	3,07	9,60	10,90	0,54	2,38	2,73
2,0+2,0+6,0	1,60	1,60	4,80	---	2,65	8,00	9,06	0,55	2,15	2,76	1,92	1,92	5,76	---	3,35	9,60	11,14	0,55	2,26	2,50
2,0+2,0+7,1	1,44	1,44	5,12	---	2,80	8,00	9,45	0,59	2,15	3,02	1,73	1,73	6,14	---	3,65	9,60	11,17	0,58	2,25	2,49
2,0+2,5+2,5	2,00	2,50	2,50	---	2,25	7,00	7,45	0,48	1,79	1,98	2,43	3,04	3,04	---	2,52	8,50	10,57	0,49	2,10	2,62
2,0+2,5+3,5	1,85	2,31	3,24	---	2,39	7,40	8,13	0,51	1,95	2,31	2,33	2,91	4,07	---	2,79	9,30	10,66	0,53	2,39	2,66
2,0+2,5+4,2	1,84	2,30	3,86	---	2,48	8,00	8,45	0,54	2,25	2,49	2,21	2,76	4,63	---	2,99	9,60	10,67	0,55	2,50	2,64
2,0+2,5+5,0	1,68	2,11	4,21	---	2,58	8,00	8,79	0,54	2,18	2,61	2,02	2,53	5,05	---	3,21	9,60	11,09	0,55	2,34	2,76
2,0+2,5+6,0	1,52	1,90	4,57	---	2,72	8,00	9,26	0,59	2,15	2,88	1,83	2,29	5,49	---	3,49	9,60	11,14	0,56	2,22	2,50
2,0+2,5+7,1	1,38	1,72	4,90	---	2,87	8,00	9,55	0,62	2,15	3,08	1,66	2,07	5,88	---	3,79	9,60	11,17	0,60	2,21	2,49
2,0+3,5+3,5	1,78	3,11	3,11	---	2,52	8,00	8,58	0,54	2,24	2,56	2,13	3,73	3,73	---	3,07	9,60	10,76	0,55	2,38	2,61
2,0+3,5+4,2	1,65	2,89	3,46	---	2,61	8,00	8,64	0,58	2,24	2,67	1,98	3,46	4,16	---	3,26	9,60	10,77	0,59	2,38	2,61
2,0+3,5+5,0	1,52	2,67	3,81	---	2,72	8,00	8,83	0,58	2,15	2,72	1,83	3,20	4,57	---	3,49	9,60	11,14	0,59	2,34	2,83
2,0+3,5+6,0	1,39	2,43	4,17	---	2,86	8,00	9,46	0,62	2,14	3,01	1,67	2,92	5,01	---	3,76	9,60	11,15	0,60	2,22	2,50
2,0+3,5+7,1	1,27	2,22	4,51	---	3,01	8,00	9,47	0,62	2,14	2,94	1,52	2,67	5,41	---	4,07	9,60	11,18	0,65	2,21	2,48
2,0+4,2+4,2	1,54	3,23	3,23	---	2,71	8,00	8,65	0,58	2,24	2,80	1,85	3,88	3,88	---	3,46	9,60	10,78	0,61	2,38	2,61
2,0+4,2+5,0	1,43	3,00	3,57	---	2,82	8,00	9,05	0,62	2,14	2,88	1,71	3,60	4,29	---	3,68	9,60	10,91	0,64	2,34	2,57
2,0+4,2+6,0	1,31	2,75	3,93	---	2,95	8,00	9,47	0,62	2,14	3,08	1,57	3,30	4,72	---	3,96	9,60	11,15	0,63	2,22	2,49
2,0+4,2+7,1	1,20	2,53	4,27	---	3,11	8,00	9,49	0,65	2,14	3,16	1,44	3,03	5,12	---	4,26	9,60	11,19	0,69	2,21	2,48
2,0+5,0+5,0	1,33	3,33	3,33	---	2,93	8,00	9,23	0,62	2,09	2,90	1,60	4,00	4,00	---	3,90	9,60	11,04	0,64	2,25	2,53
2,0+5,0+6,0	1,23	3,08	3,69	---	3,06	8,00	9,66	0,65	2,08	3,06	1,48	3,69	4,43	---	4,17	9,60	11,28	0,65	2,14	2,50
2,0+5,0+7,1	1,13	2,84	4,03	---	3,32	8,00	9,68	0,58	2,08	3,07	1,36	3,40	4,83	---	4,48	9,60	11,32	0,70	2,13	2,49
2,0+6,0+6,0	1,14	3,43	3,43	---	3,32	8,00	10,16	0,58	2,05	3,22	1,37	4,11	4,11	---	4,45	9,60	11,52	0,66	2,07	2,43
2,5+2,5+2,5	2,47	2,47	2,47	---	2,32	7,40	7,79	0,51	1,96	2,14	3,20	3,20	3,20	---	2,66	9,60	10,70	0,51	2,49	2,65
2,5+2,5+3,5	2,35	2,35	3,29	---	2,46	8,00	8,35	0,54	2,25	2,43	2,82	2,82	3,95	---	2,94	9,60	10,90	0,55	2,46	2,73
2,5+2,5+4,2	2,17	2,17	3,65	---	2,54	8,00	8,61	0,54	2,24	2,63	2,61	2,61	4,38	---	3,13	9,60	11,02	0,57	2,44	2,81
2,5+2,5+5,0	2,00	2,00	4,00	---	2,65	8,00	8,80	0,58	2,15	2,68	2,40	2,40	4,80	---	3,35	9,60	11,10	0,57	2,35	2,79
2,5+2,5+6,0	1,82	1,82	4,36	---	2,79	8,00	9,33	0,59	2,15	2,94	2,18	2,18	5,24	---	3,62	9,60	11,14	0,58	2,26	2,50
2,5+2,5+7,1	1,65	1,65	4,69	---	2,94	8,00	9,54	0,62	2,14	3,11	1,98	1,98	5,63	---	3,93	9,60	11,17	0,62	2,26	2,49
2,5+3,5+3,5	2,11	2,95	2,95	---	2,58	8,00	8,64	0,54	2,24	2,57	2,53	3,54	3,54	---	3,21	9,60	11,03	0,57	2,41	2,73
2,5+3,5+4,2	1,96	2,75	3,29	---	2,68	8,00	8,65	0,58	2,23	2,73	2,35	3,29	3,95	---	3,41	9,60	11,04	0,61	2,39	2,72
2,5+3,5+5,0	1,82	2,55	3,64	---	2,79	8,00	8,85	0,62	2,14	2,78	2,18	3,05	4,36	---	3,62	9,60	11,10	0,62	2,30	2,75
2,5+3,5+6,0	1,67	2,33	4,00	---	2,93	8,00	9,47	0,62	2,14	3,05	2,00	2,80	4,80	---	3,90	9,60	11,15	0,63	2,25	2,50
2,5+3,5+7,1	1,53	2,14	4,34	---	3,08	8,00	9,49	0,65	2,14	2,94	1,83	2,56	5,20	---	4,20	9,60	11,18	0,67	2,21	2,48
2,5+4,2+4,2	1,83	3,08	3,08	---	2,78	8,00	8,67	0,62	2,23	2,80	2,20	3,70	3,70	---	3,60	9,60	11,04	0,64	2,37	2,72
2,5+4,2+5,0	1,71	2,87	3,42	---	2,89	8,00	9,06	0,62	2,14	2,92	2,05	3,45	4,10	---	3,81	9,60	11,10	0,66	2,28	2,57
2,5+4,2+6,0	1,57	2,65	3,78	---	3,02	8,00	9,48	0,62	2,14	3,12	1,79	3,17	4,54	---	4,09	9,60	11,15	0,65	2,24	2,49
2,5+4,2+7,1	1,45	2,43	4,12	---	3,29	8,00	9,50	0,58	2,13	3,16	1,74	2,92	4,94	---	4,40	9,60	11,19	0,71	2,20	2,48
2,5+5,0+5,0	1,60	3,20	3,20	---	3,00	8,00	9,24	0,65	2,09	2,90	1,92	3,84	3,84	---	4,04	9,60	11,04	0,67	2,26	2,53
2,5+5,0+6,0	1,48	2,96	3,56	---	3,13	8,00	9,68	0,65	2,08	3,07	1,78	3,56	4,27	---	4,31	9,60	11,28	0,68	2,18	2,50
2,5+6,0+6,0	1,38	3,31	3,31	---	3,32	8,00	10,18	0,58	2,05	3,22	1,66	3,97	3,97	---	4,59	9,60	11,52	0,68	2,11	2,43
3,5+3,5+3,5	2,67	2,67	2,67	---	2,72	8,00	8,79	0,58	2,20	2,70	3,20	3,20	3,20	---	3,49	9,60	11,09	0,61	2,42	2,80
3,5+3,5+4,2	2,50	2,50	3,00	---	2,82	8,00	8,80	0,62	2,20	2,91	3,00	3,00	3,60	---	3,68	9,60	11,09	0,66	2,40	2,61
3,5+3,5+5,0	2,33	2,33	3,33	---	2,93	8,00	8,99	0,62	2,14	2,89	2,80	2,80	4,00	---	3,90	9,60	11,10	0,66	2,37	2,57
3,5+3,5+6,0	2,15	2,15	3,69	---	3,06	8,00	9,52	0,65	2,13	2,94	2,58	2,58	4,43	---	4,17	9,60	11,15	0,67	2,22	2,49
3,5+3,5+7,1	1,99	1,99	4,03	---	3,30	8,00	9,54	0,58	2,10	3,13	2,38	2,38	4,83	---	4,48	9,60	11,19	0,71	2,21	2,48
3,5+4,2+4,2	2,35	2,82	2,82	---	2,91	8,00	9,01	0,62	2,20	2,94	2,82	3,39	3,39	---	3,88	9,60	10,80	0,68	2,38	2,60
3,5+4,2+5,0	2,20	2,65	3,15	---	3,02	8,00	9,21	0,65	2,13	2,96	2,65	3,17	3,78	---	4,09	9,60	10,92	0,71	2,35	2,57
3,5+4,2+6,0	2,04	2,45	3,50	---	3,30	8,00	9,53	0,58	2,10	3,13	2,45	2,94	4,20	---	4,37	9,60	11,16	0,70	2,21	2,49
3,5+5,0+5,0	2,07	2,96	2,96	---	3,13	8,00	9,18	0,65	2,08	2,91	2,49	3,56	3,56	---	4,31	9,60	11,06	0,71	2,25	2,53
3,5+5,0+6,0	1,93	2,76	3,31	---	3,33	8,00	9,72	0,58	2,05	3,07	2,32	3,31	3,97	---	4,59	9,60	11,29	0,72	2,14	2,50
4,2+4,2+4,2	2,67	2,67	2,67	---	3,01	8,00	9,21	0,65	2,19	3,00	3,20	3,20	3,20	---	4,					

Opgenomen vermogen verwarmen [kW]			Totale stroom verwarmen [A]			Vermogens-factor [%]	Seizoensgegevens koelen				Seizoensgegevens verwarmen (gemiddeld klimaat)						Seizoensgegevens verwarmen (warm klimaat)					
Min.	Nom.	Max.	Min.	Nom.	Max.		label	SEER	Ontwerp-capaciteit	AEC	label	SCOP	Ontwerp-capaciteit	AEC	Opgegeven capaciteit bij -10°C	Capaciteit back-upverwarming bij -10°C	label	SCOP	Ontwerp-capaciteit	AEC	Opgegeven capaciteit bij +2°C	Capaciteit back-upverwarming bij +2°C
2,84	10,71	12,27	2,65	9,90	12,59	95	A++	8,11	9,00	389	A+	4,07	6,23	2142	4,82	1,41	A+++	5,78	3,90	944	3,90	0
2,75	10,17	11,91	2,82	9,80	13,77	95	A++	8,12	9,00	388	A+	4,10	6,23	2126	4,84	1,39	A+++	5,74	4,00	975	4,00	0
3,05	10,12	11,86	2,99	9,80	14,13	95	A++	8,12	9,00	388	A+	4,13	6,23	2111	4,85	1,38	A+++	5,70	4,10	1007	4,10	0
2,84	10,30	12,08	2,82	9,60	12,95	95	A++	8,12	9,00	388	A+	4,08	6,23	2135	4,82	1,41	A+++	5,78	3,90	944	3,90	0
2,88	9,80	11,95	2,86	9,60	13,86	95	A++	8,12	9,00	388	A+	4,11	6,23	2119	4,84	1,39	A+++	5,74	4,00	975	4,00	0
3,05	9,75	11,91	2,70	9,60	14,03	95	A++	8,13	9,00	388	A+	4,14	6,23	2104	4,86	1,37	A+++	5,70	4,10	1006	4,10	0
2,93	9,48	11,60	3,03	9,40	14,30	95	A++	8,12	9,00	388	A+	4,12	6,23	2113	4,84	1,39	A+++	5,75	4,00	974	4,00	0
2,06	7,92	11,40	2,19	6,40	7,73	95	A++	8,20	6,00	256	A	3,89	4,57	1644	3,87	0,70	A+++	5,66	3,60	890	3,60	0
2,15	8,56	11,58	2,19	7,30	8,40	95	A++	8,21	6,50	278	A	3,90	4,57	1638	3,87	0,70	A+++	5,65	3,60	892	3,60	0
2,32	10,12	12,17	2,32	9,00	9,90	95	A++	8,19	7,40	317	A	3,91	5,37	1919	4,33	1,04	A+++	5,69	3,70	911	3,70	0
2,41	11,03	11,99	2,32	10,30	10,90	95	A++	8,07	8,20	356	A	3,93	5,37	1913	4,33	1,04	A+++	5,67	3,70	912	3,70	0
2,45	10,90	12,49	2,48	10,00	11,50	95	A++	8,07	8,00	347	A+	4,01	6,23	2172	4,82	1,41	A+++	5,65	3,80	941	3,80	0
2,50	10,35	11,95	2,53	9,90	12,70	95	A++	8,03	8,50	371	A+	4,04	6,23	2156	4,84	1,39	A+++	5,61	3,90	973	3,90	0
2,67	10,30	11,91	2,69	9,90	13,90	95	A++	7,99	9,00	395	A+	4,07	6,23	2140	4,86	1,37	A+++	5,57	4,00	1005	4,00	0
2,24	9,62	11,99	2,19	8,20	9,10	95	A++	8,23	7,00	298	A	3,93	4,77	1697	3,99	0,78	A+++	5,70	3,60	885	3,60	0
2,41	10,94	12,17	2,32	9,00	10,70	95	A++	8,19	7,40	317	A	3,95	5,37	1902	4,33	1,04	A+++	5,72	3,70	906	3,70	0
2,54	11,45	12,08	2,48	10,30	11,50	95	A++	8,12	8,70	375	A	3,96	5,37	1896	4,34	1,03	A+++	5,71	3,70	908	3,70	0
2,54	10,71	12,63	2,48	10,00	11,96	95	A++	8,07	8,00	347	A+	4,05	6,23	2152	4,82	1,41	A+++	5,68	3,90	961	3,90	0
2,58	10,17	11,95	2,69	9,90	13,30	95	A++	8,00	8,70	381	A+	4,08	6,23	2137	4,84	1,39	A+++	5,64	4,00	993	4,00	0
2,75	10,12	11,91	2,82	9,90	14,20	95	A++	8,00	9,00	394	A+	4,11	6,23	2121	4,86	1,37	A+++	5,60	4,00	1000	4,00	0
2,54	10,90	12,48	2,48	10,30	11,80	95	A++	8,05	8,00	348	A+	4,10	6,23	2124	4,81	1,42	A+++	5,89	3,90	927	3,90	0
2,71	10,90	12,48	2,65	10,30	12,21	95	A++	8,02	8,50	371	A+	4,11	6,23	2118	4,82	1,41	A+++	5,88	3,90	928	3,90	0
2,71	10,71	12,95	2,65	9,90	12,43	95	A++	7,99	8,70	381	A+	4,17	6,23	2088	4,83	1,40	A+++	5,79	4,10	991	4,10	0
2,75	10,17	11,95	2,82	9,80	13,77	95	A++	7,99	9,00	394	A+	4,20	6,23	2073	4,85	1,38	A+++	5,75	4,20	1022	4,20	0
2,97	10,12	11,86	2,82	9,80	13,44	95	A++	8,00	9,00	394	A+	4,23	6,23	2058	4,87	1,36	A+++	5,71	4,20	1030	4,20	0
2,80	10,90	12,48	2,65	10,30	12,82	95	A++	8,00	8,70	381	A+	4,13	6,23	2111	4,82	1,41	A+++	5,88	4,00	952	4,00	0
2,93	10,71	12,26	2,82	9,90	13,19	95	A++	7,98	9,00	395	A+	4,19	6,23	2081	4,83	1,40	A+++	5,79	4,10	990	4,10	0
2,88	10,17	11,91	2,82	9,80	14,11	95	A++	7,99	9,00	395	A+	4,22	6,23	2066	4,85	1,38	A+++	5,75	4,20	1022	4,20	0
3,14	10,12	11,86	2,99	9,80	14,47	95	A++	8,00	9,00	394	A+	4,25	6,23	2052	4,87	1,36	A+++	5,71	4,30	1054	4,30	0
2,93	10,30	12,08	2,82	9,60	13,27	95	A++	8,02	9,00	393	A+	4,20	6,23	2075	4,84	1,39	A+++	5,80	4,10	990	4,10	0
2,97	9,80	11,95	2,99	9,60	14,03	95	A++	8,02	9,00	393	A+	4,23	6,23	2060	4,85	1,38	A+++	5,76	4,20	1021	4,20	0
3,18	9,75	11,91	2,70	9,60	14,03	95	A++	8,03	9,00	392	A+	4,26	6,23	2046	4,87	1,36	A+++	5,71	4,30	1053	4,30	0
3,01	9,48	11,60	2,70	9,40	14,72	95	A++	8,03	9,00	393	A+	4,24	6,23	2054	4,86	1,37	A+++	5,76	4,20	1021	4,20	0
2,32	11,40	12,13	2,32	9,00	9,90	95	A++	8,19	7,40	316	A+	4,04	4,77	1651	4,00	0,77	A+++	5,79	3,70	894	3,70	0
2,54	11,26	12,49	2,48	10,30	11,20	95	A++	8,06	8,00	347	A+	4,06	5,37	1850	4,35	1,02	A+++	5,81	3,70	891	3,70	0
2,62	11,17	13,40	2,48	10,30	12,04	95	A++	8,08	8,00	347	A+	4,07	5,37	1844	4,35	1,02	A+++	5,80	3,80	917	3,80	0
2,62	10,76	12,77	2,65	9,90	12,27	95	A++	8,02	8,50	371	A+	4,15	6,23	2100	4,84	1,39	A+++	5,77	3,90	945	3,90	0
2,67	10,35	11,95	2,69	9,90	13,45	95	A++	8,00	9,00	394	A+	4,18	6,23	2084	4,86	1,37	A+++	5,73	4,00	977	4,00	0
2,84	10,35	11,91	2,82	9,90	14,24	95	A++	8,01	9,00	394	A+	4,21	6,23	2069	4,88	1,35	A+++	5,69	4,10	1009	4,10	0
2,62	11,03	12,49	2,48	10,30	11,76	95	A++	8,07	8,00	347	A+	4,10	6,23	2124	4,83	1,40	A+++	5,87	3,80	905	3,80	0
2,80	10,94	12,45	2,65	10,30	12,52	95	A++	8,03	8,50	371	A+	4,11	6,23	2118	4,83	1,40	A+++	5,86	3,80	907	3,80	0
2,84	10,53	12,59	2,82	9,90	12,74	95	A++	7,99	9,00	395	A+	4,17	6,23	2087	4,84	1,39	A+++	5,78	3,90	945	3,90	0
2,88	10,30	11,95	2,82	9,80	13,94	95	A++	8,00	9,00	394	A+	4,20	6,23	2072	4,86	1,37	A+++	5,73	4,00	976	4,00	0
3,05	10,12	11,86	2,99	9,80	13,45	95	A++	8,00	9,00	394	A+	4,23	6,23	2058	4,88	1,35	A+++	5,69	4,10	1008	4,10	0
2,93	10,85	12,45	2,82	10,30	12,83	95	A++	7,96	9,00	396	A+	4,13	6,23	2111	4,84	1,39	A+++	5,87	3,80	907	3,80	0
3,01	10,44	11,76	2,82	9,90	13,36	95	A++	7,94	9,00	397	A+	4,19	6,23	2081	4,85	1,38	A+++	5,78	4,00	969	4,00	0
2,97	10,26	11,91	2,82	9,80	14,30	95	A++	7,94	9,00	397	A+	4,22	6,23	2066	4,87	1,36	A+++	5,74	4,00	976	4,00	0
3,27	10,07	11,86	2,70	9,80	14,48	95	A++	7,95	9,00	396	A+	4,25	6,23	2052	4,88	1,35	A+++	5,70	4,10	1007	4,10	0
3,05	10,35	12,08	2,99	9,60	13,27	95	A++	8,03	9,00	393	A+	4,20	6,23	2074	4,85	1,38	A+++	5,78	4,00	968	4,00	0
3,10	9,98	11,95	2,99	9,60	14,03	95	A++	8,03	9,00	392	A+	4,23	6,23	2059	4,87	1,36	A+++	5,74	4,10	1000	4,10	0
3,10	9,66	11,60	2,70	9,40	14,73	95	A++	8,04	9,00	392	A+	4,27	6,23	2042	4,87	1,36	A+++	5,75	4,10	998	4,10	0
2,80	11,08	12,81	2,65	10,10	12,36	95	A++	8,00	8,70	381	A+	4,13	6,23	2107	4,85	1,38	A+++	5,85	4,00	956	4,00	0
3,01	10,99	11,95	2,82	10,10	13,31	95	A++	7,93	9,00	397	A+	4,15	6,23	2101	4,86	1,37	A+++	5,84	4,00	958	4,00	0
3,01	10,85	11,76	2,82	9,80	13,23	95	A++	7,91	9,00	398	A+	4,21	6,23	2072	4,87	1,36	A+++	5,76	4,10	997	4,10	0
3,05	10,17	11,91	2,99	9,80	13,46	95	A++	7,92	9,00	398	A+	4,24	6,23	2057	4,89	1,34	A+++	5,71	4,20	1029	4,20	0
3,27	10,12	11,86	2,70	9,70	14,32	95	A++	7,93	9,00	398	A+	4,26	6,23	2043	4,91	1,32	A+++	5,67	4,30	1061	4,30	0
3,10	10,90	12,43	2,82	10,10	13,45	95	A++	7,94	9,00	397	A+	4,16	6,23	2094	4,86	1,37	A+++	5,85	4,00	958	4,00	0
3,23	10,76	12,26	2,99	9,80	13,53	95	A++	7,92	9,00	398	A+	4,22	6,23	2065	4,87	1,36	A+++	5,76	4,20	1021	4,20	0
3,18	10,12	11,91	2,70	9,70	14,32	95	A++	7,92	9,00	398	A+	4,25	6,23	2051	4,89	1,34	A+++	5,72	4,20	1028	4,20	0
3,27	10,30	12,08	2,99	9,60	13,30	95	A++	8,04	9,00	392	A+	4,27	6,23	2039	4,88	1,35	A+++	5,78	4,20	1017	4,20	0
3,31	9,80	11,95	2,70	9,40	14,05	95	A++	8,04	9,00	392	A+	4,30	6,23	2025								

Combinatietabellen

Binneneunit	Koelcapaciteit [kW]				Totale koelcapaciteit [kW]			Opgenomen vermogen koelen [kW]			Totale stroom koelen [A]			Verwarmingscapaciteit [kW]				Totale verwarmingscapaciteit [kW]		
	Kamer A	Kamer B	Kamer C	Kamer D	Min.	Nom.	Max.	Min.	Nom.	Max.	Min.	Nom.	Max.	Kamer A	Kamer B	Kamer C	Kamer D	Min.	Nom.	Max.
1,5+1,5+1,5+6,0	1,14	1,14	1,14	4,57	2,72	8,00	9,19	0,56	1,98	2,55	1,37	1,37	1,37	5,49	3,49	9,60	11,53	0,49	2,06	2,43
1,5+1,5+1,5+7,1	1,03	1,03	1,03	4,90	2,87	8,00	9,53	0,59	1,98	2,74	1,24	1,24	1,24	5,88	3,79	9,60	11,56	0,53	2,05	2,42
1,5+1,5+2,0+2,0	1,50	1,50	2,00	2,00	2,25	7,00	7,46	0,49	1,53	1,81	1,82	1,82	2,43	2,43	2,52	8,50	10,47	0,41	1,99	2,27
1,5+1,5+2,0+2,5	1,48	1,48	1,97	2,47	2,32	7,40	7,82	0,52	1,77	1,94	1,80	1,80	2,40	3,00	2,66	9,00	10,57	0,43	2,14	2,31
1,5+1,5+2,0+3,5	1,41	1,41	1,88	3,29	2,46	8,00	8,34	0,52	2,03	2,17	1,69	1,69	2,26	3,95	2,94	9,60	10,67	0,49	2,22	2,30
1,5+1,5+2,0+4,2	1,30	1,30	1,74	3,65	2,54	8,00	8,70	0,55	2,03	2,35	1,57	1,57	2,09	4,38	3,13	9,60	11,16	0,50	2,21	2,49
1,5+1,5+2,0+5,0	1,20	1,20	1,60	4,00	2,65	8,00	9,05	0,55	1,99	2,48	1,44	1,44	1,92	4,80	3,35	9,60	11,29	0,51	2,14	2,50
1,5+1,5+2,0+6,0	1,09	1,09	1,45	4,36	2,79	8,00	9,41	0,59	1,98	2,67	1,31	1,31	1,75	5,24	3,62	9,60	11,53	0,51	2,06	2,43
1,5+1,5+2,0+7,1	0,99	0,99	1,32	4,69	2,94	8,00	9,64	0,63	1,98	2,80	1,19	1,19	1,59	5,63	3,93	9,60	11,56	0,55	2,05	2,42
1,5+1,5+2,5+2,5	1,39	1,39	2,31	2,31	2,39	7,40	8,07	0,52	1,77	2,06	1,80	1,80	3,00	3,00	2,79	9,60	10,58	0,45	2,21	2,31
1,5+1,5+2,5+3,5	1,33	1,33	2,22	3,11	2,52	8,00	8,58	0,55	2,03	2,29	1,60	1,60	2,67	3,73	3,07	9,60	11,15	0,51	2,22	2,49
1,5+1,5+2,5+4,2	1,24	1,24	2,06	3,46	2,61	8,00	8,93	0,55	2,03	2,47	1,48	1,48	2,47	4,16	3,26	9,60	11,16	0,52	2,21	2,49
1,5+1,5+2,5+5,0	1,14	1,14	1,90	3,81	2,72	8,00	9,17	0,59	1,98	2,55	1,37	1,37	2,29	4,57	3,49	9,60	11,29	0,53	2,14	2,50
1,5+1,5+2,5+6,0	1,04	1,04	1,74	4,17	2,86	8,00	9,53	0,59	1,98	2,74	1,25	1,25	2,09	5,01	3,76	9,60	11,53	0,54	2,06	2,43
1,5+1,5+2,5+7,1	0,95	0,95	1,59	4,51	3,01	8,00	9,75	0,63	1,98	2,87	1,14	1,14	1,90	5,41	4,07	9,60	11,56	0,58	2,05	2,42
1,5+1,5+3,5+3,5	1,20	1,20	2,80	2,80	2,65	8,00	9,07	0,55	2,00	2,54	1,44	1,44	3,36	3,36	3,35	9,60	11,16	0,55	2,21	2,49
1,5+1,5+3,5+4,2	1,12	1,12	2,62	3,14	2,75	8,00	9,30	0,59	2,00	2,66	1,35	1,35	3,14	3,77	3,54	9,60	11,17	0,56	2,21	2,49
1,5+1,5+3,5+5,0	1,04	1,04	2,43	3,48	2,86	8,00	9,54	0,59	1,98	2,74	1,25	1,25	2,92	4,17	3,76	9,60	11,29	0,58	2,13	2,49
1,5+1,5+3,5+6,0	0,96	0,96	2,24	3,84	3,00	8,00	9,67	0,63	1,95	2,81	1,15	1,15	2,69	4,61	4,04	9,60	11,53	0,57	2,06	2,42
1,5+1,5+3,5+7,1	0,88	0,88	2,06	4,18	3,15	8,00	9,78	0,66	1,95	2,87	1,06	1,06	2,47	5,01	4,35	9,60	11,58	0,63	2,05	2,41
1,5+1,5+4,2+4,2	1,05	1,05	2,95	2,95	2,84	8,00	9,52	0,59	2,00	2,79	1,26	1,26	3,54	3,54	3,73	9,60	11,18	0,60	2,21	2,48
1,5+1,5+4,2+5,0	0,98	0,98	2,75	3,28	2,95	8,00	9,65	0,63	1,98	2,81	1,18	1,18	3,30	3,93	3,96	9,60	11,30	0,60	2,13	2,49
1,5+1,5+4,2+6,0	0,91	0,91	2,55	3,64	3,09	8,00	9,78	0,63	1,95	2,87	1,09	1,09	3,05	4,36	4,23	9,60	11,54	0,61	2,06	2,42
1,5+1,5+4,2+7,1	0,84	0,84	2,35	3,97	3,38	8,00	9,79	0,57	1,95	2,87	1,01	1,01	2,82	4,77	4,54	9,60	11,58	0,65	2,05	2,41
1,5+1,5+5,0+5,0	0,92	0,92	3,08	3,08	3,06	8,00	9,77	0,63	1,94	2,82	1,11	1,11	3,69	3,69	4,17	9,60	11,44	0,63	2,09	2,46
1,5+1,5+5,0+6,0	0,86	0,86	2,86	3,43	3,20	8,00	9,78	0,66	1,93	2,82	1,03	1,03	3,43	4,11	4,45	9,60	11,68	0,63	1,97	2,38
1,5+2,0+2,0+2,0	1,48	1,97	1,97	1,97	2,32	7,40	7,81	0,52	1,77	1,94	1,90	2,53	2,53	2,53	2,66	9,50	10,66	0,43	2,26	2,35
1,5+2,0+2,0+2,5	1,39	1,85	1,85	2,31	2,39	7,40	8,07	0,52	1,77	2,06	1,80	2,40	2,40	3,00	2,79	9,60	10,75	0,45	2,26	2,36
1,5+2,0+2,0+3,5	1,33	1,78	1,78	3,11	2,52	8,00	8,57	0,55	2,03	2,29	1,60	2,13	2,13	3,73	3,07	9,60	11,15	0,51	2,25	2,49
1,5+2,0+2,0+4,2	1,24	1,65	1,65	3,46	2,61	8,00	8,92	0,55	2,03	2,47	1,48	1,98	1,98	4,16	3,26	9,60	11,16	0,52	2,23	2,49
1,5+2,0+2,0+5,0	1,14	1,52	1,52	3,81	2,72	8,00	9,17	0,59	1,99	2,54	1,37	1,83	1,83	4,57	3,49	9,60	11,29	0,53	2,14	2,50
1,5+2,0+2,0+6,0	1,04	1,39	1,39	4,17	2,86	8,00	9,52	0,59	1,98	2,74	1,25	1,67	1,67	5,01	3,76	9,60	11,53	0,54	2,06	2,43
1,5+2,0+2,0+7,1	0,95	1,27	1,27	4,51	3,01	8,00	9,74	0,63	1,98	2,87	1,14	1,52	1,52	5,41	4,07	9,60	11,56	0,58	2,05	2,42
1,5+2,0+2,5+2,5	1,41	1,88	2,35	2,35	2,46	8,00	8,32	0,52	2,04	2,17	1,69	2,26	2,82	2,82	2,94	9,60	10,75	0,49	2,22	2,31
1,5+2,0+2,5+3,5	1,26	1,68	2,11	2,95	2,58	8,00	8,81	0,55	2,03	2,41	1,52	2,02	2,53	3,54	3,21	9,60	11,15	0,53	2,22	2,49
1,5+2,0+2,5+4,2	1,18	1,57	1,96	3,29	2,68	8,00	9,15	0,59	2,03	2,60	1,41	1,88	2,35	3,95	3,41	9,60	11,16	0,55	2,21	2,49
1,5+2,0+2,5+5,0	1,09	1,45	1,82	3,64	2,79	8,00	9,40	0,59	1,98	2,67	1,31	1,75	2,18	4,36	3,62	9,60	11,29	0,56	2,14	2,50
1,5+2,0+2,5+6,0	1,00	1,33	1,67	4,00	2,93	8,00	9,64	0,63	1,98	2,80	1,20	1,60	2,00	4,80	3,90	9,60	11,53	0,55	2,06	2,43
1,5+2,0+2,5+7,1	0,92	1,22	1,53	4,34	3,08	8,00	9,75	0,63	1,98	2,87	1,10	1,47	1,83	5,20	4,20	9,60	11,56	0,61	2,05	2,42
1,5+2,0+3,5+3,5	1,14	1,52	2,67	2,67	2,72	8,00	9,18	0,59	2,00	2,60	1,37	1,83	3,20	3,20	3,49	9,60	11,16	0,56	2,21	2,49
1,5+2,0+3,5+4,2	1,07	1,43	2,50	3,00	2,82	8,00	9,40	0,59	2,00	2,73	1,29	1,71	3,00	3,60	3,68	9,60	11,17	0,58	2,21	2,49
1,5+2,0+3,5+5,0	1,00	1,33	2,33	3,33	2,93	8,00	9,64	0,63	1,98	2,81	1,20	1,60	2,80	4,00	3,90	9,60	11,29	0,60	2,13	2,49
1,5+2,0+3,5+6,0	0,92	1,23	2,15	3,69	3,06	8,00	9,77	0,63	1,95	2,87	1,11	1,48	2,58	4,43	4,17	9,60	11,53	0,61	2,06	2,42
1,5+2,0+3,5+7,1	0,85	1,13	1,99	4,03	3,38	8,00	9,78	0,57	1,95	2,87	1,02	1,36	2,38	4,83	4,48	9,60	11,58	0,65	2,05	2,41
1,5+2,0+4,2+4,2	1,01	1,34	2,82	2,82	2,91	8,00	9,57	0,62	2,00	2,85	1,21	1,61	3,39	3,39	3,88	9,60	11,18	0,62	2,25	2,48
1,5+2,0+4,2+5,0	0,94	1,26	2,65	3,15	3,02	8,00	9,71	0,63	1,98	2,86	1,13	1,51	3,17	3,78	4,09	9,60	11,30	0,63	2,13	2,49
1,5+2,0+4,2+6,0	0,88	1,17	2,45	3,50	3,16	8,00	9,78	0,66	1,95	2,87	1,05	1,40	2,94	4,20	4,37	9,60	11,54	0,63	2,06	2,42
1,5+2,0+5,0+5,0	0,89	1,19	2,96	2,96	3,13	8,00	9,77	0,65	1,94	2,82	1,07	1,42	3,56	3,56	4,31	9,60	11,44	0,65	2,09	2,46
1,5+2,0+5,0+6,0	0,83	1,10	2,76	3,31	3,40	8,00	9,78	0,57	1,93	2,82	0,99	1,32	3,31	3,97	4,59	9,60	11,68	0,66	1,97	2,38
1,5+2,5+2,5+2,5	1,33	2,22	2,22	2,22	2,52	8,00	8,56	0,55	2,04	2,29	1,60	2,67	2,67	2,67	3,07	9,60	11,14	0,51	2,22	2,50
1,5+2,5+2,5+3,5	1,20	2,00	2,00	2,80	2,65	8,00	9,05	0,55	2,03	2,54	1,44	2,40	2,40	3,36	3,35	9,60	11,15	0,55	2,22	2,49
1,5+2,5+2,5+4,2	1,12	1,87	1,87	3,14	2,75	8,00	9,27	0,59	2,03	2,66	1,35	2,24	2,24	3,77	3,54	9,60	11,16	0,56	2,21	2,49
1,5+2,5+2,5+5,0	1,04	1,74	1,74	3,48	2,86	8,00	9,52	0,59	1,98	2,74	1,25	2,09	2,09	4,17	3,76	9,60	11,29	0,58	2,14	2,50
1,5+2,5+2,5+6,0	0,96	1,60	1,60	3,84	3,00	8,00	9,65	0,63	1,98	2,81	1,15	1,92	1,92	4,61	4,04	9,60	11,53	0,57	2,06	2,43
1,5+2,5+2,5+7,1	0,88	1,47	1,47	4,18	3,15	8,00	9,76	0,66	1,98	2,87	1,06	1,76	1,76	5,01	4,35	9,60	11,56	0,63	2,05	2,42
1,5+2,5+3,5+3,5	1,09	1,82	2,55	2,55	2,79	8,00	9,35	0,59	2,00	2,71	1,31	2,18	3,05	3,05	3,62	9,60	11,16	0,58	2,21	2,49
1,5+2,5+3,5+4,2	1,03	1,71	2,39	2,87	2,89	8,00	9,47	0,62	2,00	2,78	1,23	2,05	2,87	3,45	3,81	9,60	11,17	0,60	2,24	2,49
1,5+2,5+3,5+5,0	0,96	1,60	2,24	3,20	3,00	8,00	9,65	0,63	1,98	2,81	1,15	1,92	2,69	3,84	4,04	9,60	11,29	0,63	2,13	2,49
1,5+2,5+3,5+6,0	0,89	1,48	2,07	3,56	3,13	8,00	9,78	0,66	1,95	2,87	1,07	1,78	2,49</							

Opgenomen vermogen verwarmen [kW]			Totale stroom verwarmen [A]			Vermogensfactor [%]	Seizoensgegevens koelen				Seizoensgegevens verwarmen (gemiddeld klimaat)						Seizoensgegevens verwarmen (warm klimaat)					
Min.	Nom.	Max.	Min.	Nom.	Max.		label	SEER	Ontwerp-capaciteit	AEC	label	SCOP	Ontwerp-capaciteit	AEC	Opgegeven capaciteit bij -10°C	Capaciteit back-upverwarming bij -10°C	label	SCOP	Ontwerp-capaciteit	AEC	Opgegeven capaciteit bij +2°C	Capaciteit back-upverwarming bij +2°C
2,24	9,43	11,60	2,57	9,10	11,70	95	A++	7,81	8,70	390	A+	4,20	6,23	2072	4,87	1,36	A+++	5,77	3,80	922	3,80	0
2,41	9,39	11,56	2,69	9,10	12,60	95	A++	7,85	9,00	401	A+	4,24	6,23	2056	4,88	1,35	A+++	5,73	3,90	952	3,90	0
1,89	9,11	10,39	2,23	7,00	8,29	95	A+++	8,55	7,00	287	A+	4,14	6,23	2106	4,85	1,38	A+++	5,94	3,50	825	3,50	0
1,98	9,80	10,57	2,36	8,20	9,00	95	A++	8,32	7,40	311	A+	4,15	6,23	2098	4,85	1,38	A+++	5,94	3,50	825	3,50	0
2,24	10,17	10,53	2,36	9,40	10,00	95	A++	8,04	8,00	349	A+	4,18	6,23	2082	4,86	1,37	A+++	5,93	3,50	826	3,50	0
2,28	10,12	11,91	2,53	9,40	10,90	95	A++	8,04	8,00	349	A+	4,20	6,23	2075	4,86	1,37	A+++	5,92	3,60	851	3,60	0
2,32	9,80	11,95	2,53	9,10	11,40	95	A++	7,86	8,50	379	A+	4,27	6,23	2041	4,87	1,36	A+++	5,86	3,70	884	3,70	0
2,32	9,43	11,60	2,69	9,10	12,30	95	A++	7,85	9,00	401	A+	4,30	6,23	2025	4,88	1,35	A+++	5,82	3,80	913	3,80	0
2,50	9,39	11,56	2,86	9,10	12,90	95	A++	7,87	9,00	401	A+	4,34	6,23	2009	4,88	1,35	A+++	5,79	3,90	943	3,90	0
2,06	10,12	11,03	2,36	8,20	9,50	95	A++	8,32	7,40	311	A+	4,17	6,23	2089	4,85	1,38	A+++	5,95	3,50	823	3,50	0
2,32	10,17	11,91	2,53	9,30	10,60	95	A++	8,05	8,00	348	A+	4,20	6,23	2074	4,86	1,37	A+++	5,94	3,60	848	3,60	0
2,37	10,12	11,91	2,53	9,30	11,40	95	A++	7,84	8,50	380	A+	4,22	6,23	2066	4,87	1,36	A+++	5,94	3,60	849	3,60	0
2,41	9,80	11,95	2,69	9,10	11,70	95	A++	7,82	8,70	390	A+	4,29	6,23	2032	4,88	1,35	A+++	5,87	3,70	882	3,70	0
2,45	9,43	11,60	2,69	9,10	12,60	95	A++	7,81	9,00	404	A+	4,32	6,23	2017	4,88	1,35	A+++	5,84	3,80	911	3,80	0
2,67	9,39	11,56	2,86	9,10	13,20	95	A++	7,82	9,00	403	A+	4,35	6,23	2001	4,88	1,35	A+++	5,80	3,90	941	3,90	0
2,50	10,12	11,91	2,53	9,20	11,70	95	A++	7,84	8,50	380	A+	4,22	6,23	2066	4,87	1,36	A+++	5,95	3,60	847	3,60	0
2,58	10,12	11,91	2,69	9,20	12,30	95	A++	7,79	9,00	405	A+	4,23	6,23	2058	4,87	1,36	A+++	5,95	3,60	847	3,60	0
2,67	9,75	11,91	2,69	9,10	12,60	95	A++	7,78	9,00	405	A+	4,30	6,23	2024	4,88	1,35	A+++	5,88	3,80	904	3,80	0
2,62	9,43	11,56	2,86	9,00	12,90	95	A++	7,80	9,00	404	A+	4,34	6,23	2009	4,88	1,35	A+++	5,85	3,80	909	3,80	0
2,88	9,39	11,51	3,03	9,00	13,20	95	A++	7,82	9,00	403	A+	4,37	6,23	1994	4,89	1,34	A+++	5,81	3,90	939	3,90	0
2,75	10,12	11,86	2,69	9,20	12,90	95	A++	7,79	9,00	404	A+	4,25	6,23	2050	4,87	1,36	A+++	5,96	3,70	869	3,70	0
2,75	9,75	11,91	2,86	9,10	12,90	95	A++	7,79	9,00	405	A+	4,32	6,23	2017	4,88	1,35	A+++	5,90	3,80	902	3,80	0
2,80	9,43	11,56	2,86	9,00	13,20	95	A++	7,81	9,00	404	A+	4,35	6,23	2001	4,89	1,34	A+++	5,86	3,90	931	3,90	0
2,97	9,39	11,51	2,70	9,00	13,20	95	A++	7,82	9,00	403	A+	4,39	6,23	1986	4,89	1,34	A+++	5,83	3,90	937	3,90	0
2,88	9,57	11,73	2,86	8,90	13,00	95	A++	7,84	9,00	402	A+	4,34	6,23	2009	4,89	1,34	A+++	5,91	3,80	900	3,80	0
2,88	9,02	11,38	3,03	8,90	13,00	95	A++	7,85	9,00	401	A+	4,37	6,23	1993	4,89	1,34	A+++	5,87	3,90	930	3,90	0
1,98	10,35	10,76	2,36	8,20	9,00	95	A++	8,32	7,40	311	A+	4,10	6,23	2125	4,85	1,38	A+++	5,99	3,50	817	3,50	0
2,06	10,35	10,80	2,36	8,20	9,50	95	A++	8,18	7,40	317	A+	4,11	6,23	2122	4,86	1,37	A+++	5,99	3,50	818	3,50	0
2,32	10,30	11,91	2,53	9,40	10,60	95	A++	8,05	8,00	348	A+	4,12	6,23	2116	4,87	1,36	A+++	5,97	3,60	843	3,60	0
2,37	10,21	11,91	2,53	9,40	11,40	95	A++	7,84	8,50	380	A+	4,12	6,23	2113	4,87	1,36	A+++	5,97	3,60	844	3,60	0
2,41	9,80	11,95	2,69	9,10	11,70	95	A++	7,81	8,70	390	A+	4,19	6,23	2078	4,88	1,35	A+++	5,91	3,70	877	3,70	0
2,45	9,43	11,60	2,69	9,10	12,60	95	A++	7,81	9,00	404	A+	4,23	6,23	2061	4,88	1,35	A+++	5,87	3,80	906	3,80	0
2,67	9,39	11,56	2,86	9,10	13,20	95	A++	7,82	9,00	403	A+	4,26	6,23	2045	4,89	1,34	A+++	5,83	3,90	936	3,90	0
2,24	10,17	10,57	2,36	9,40	10,00	95	A++	8,01	8,00	350	A+	4,10	6,23	2128	4,86	1,37	A+++	6,00	3,50	817	3,50	0
2,41	10,17	11,91	2,53	9,30	11,10	95	A++	8,03	8,00	349	A+	4,13	6,23	2112	4,87	1,36	A+++	5,98	3,60	842	3,60	0
2,50	10,12	11,91	2,69	9,30	11,90	95	A++	7,83	8,50	380	A+	4,14	6,23	2104	4,87	1,36	A+++	5,98	3,60	842	3,60	0
2,58	9,80	11,95	2,69	9,10	12,30	95	A++	7,79	9,00	404	A+	4,21	6,23	2069	4,88	1,35	A+++	5,92	3,80	899	3,80	0
2,54	9,43	11,60	2,86	9,10	12,90	95	A++	7,81	9,00	404	A+	4,24	6,23	2053	4,89	1,34	A+++	5,88	3,80	904	3,80	0
2,80	9,39	11,56	2,86	9,10	13,20	95	A++	7,83	9,00	403	A+	4,28	6,23	2038	4,89	1,34	A+++	5,85	3,90	934	3,90	0
2,58	10,12	11,91	2,69	9,20	12,00	95	A++	7,81	8,70	390	A+	4,14	6,23	2103	4,87	1,36	A+++	6,00	3,60	840	3,60	0
2,67	10,12	11,91	2,69	9,20	12,50	95	A++	7,79	9,00	404	A+	4,16	6,23	2096	4,88	1,35	A+++	5,99	3,70	864	3,70	0
2,75	9,75	11,91	2,86	9,10	12,90	95	A++	7,79	9,00	405	A+	4,23	6,23	2061	4,89	1,34	A+++	5,93	3,80	897	3,80	0
2,80	9,43	11,56	2,86	9,00	13,20	95	A++	7,81	9,00	404	A+	4,26	6,23	2045	4,89	1,34	A+++	5,89	3,90	926	3,90	0
2,97	9,39	11,51	2,70	9,00	13,20	95	A++	7,82	9,00	403	A+	4,29	6,23	2030	4,90	1,33	A+++	5,86	3,90	932	3,90	0
2,84	10,30	11,86	2,82	9,20	13,02	95	A++	7,80	9,00	404	A+	4,17	6,23	2087	4,88	1,35	A+++	6,00	3,70	863	3,70	0
2,88	9,75	11,91	2,86	9,10	13,08	95	A++	7,80	9,00	404	A+	4,24	6,23	2053	4,89	1,34	A+++	5,94	3,80	895	3,80	0
2,88	9,43	11,56	3,03	9,00	13,20	95	A++	7,81	9,00	403	A+	4,28	6,23	2037	4,90	1,33	A+++	5,91	3,90	924	3,90	0
2,97	9,57	11,73	2,99	8,90	13,00	95	A++	7,84	9,00	402	A+	4,40	6,23	1979	4,90	1,33	A+++	6,00	3,90	910	3,90	0
3,01	9,02	11,38	2,70	8,90	13,00	95	A++	7,85	9,00	401	A+	4,44	6,23	1964	4,90	1,33	A+++	5,96	3,90	916	3,90	0
2,32	10,17	11,95	2,53	9,40	10,60	95	A++	8,03	8,00	349	A+	4,09	6,23	2129	4,88	1,35	A+++	6,11	3,60	824	3,60	0
2,50	10,17	11,91	2,53	9,30	11,70	95	A++	7,83	8,50	380	A+	4,12	6,23	2113	4,88	1,35	A+++	6,10	3,60	826	3,60	0
2,58	10,12	11,91	2,69	9,30	12,30	95	A++	7,80	9,00	404	A+	4,14	6,23	2105	4,89	1,34	A+++	6,10	3,70	849	3,70	0
2,67	9,80	11,95	2,69	9,10	12,60	95	A++	7,80	9,00	404	A+	4,21	6,23	2070	4,90	1,33	A+++	6,03	3,80	882	3,80	0
2,62	9,43	11,60	2,86	9,10	12,90	95	A++	7,81	9,00	403	A+	4,24	6,23	2054	4,90	1,33	A+++	6,00	3,90	910	3,90	0
2,88	9,39	11,56	3,03	9,10	13,20	95	A++	7,83	9,00	403	A+	4,28	6,23	2038	4,91	1,32	A+++	5,96	3,90	916	3,90	0
2,67	10,12	11,91	2,69	9,20	12,42	95	A++	7,87	9,00	400	A+	4,14	6,23	2104	4,89	1,34	A+++	6,11	3,70	847	3,70	0
2,75	10,26	11,91	2,82	9,20	12,72	95	A++	7,88	9,00	400	A+	4,15	6,23	2101	4,89	1,34	A+++	6,03	3,70	859	3,70	0
2,88	9,75	11,91	2,86	9,10	12,90	95	A++	7,87	9,00	400	A+	4,22	6,23	2066	4,90	1,33	A+++	5,97	3,80	891	3,80	0
2,88	9,43	11,56	3,03	9,00	13,20	95	A++	7,89	9,00	400	A+	4,45	6,23	1960	4,91	1,32	A+++	5,93	3,90	920	3,90	0
2,97	10,30	11,86	2,82	9,20	13,03	95	A++	7,88	9,00	400	A+	4,15	6,23	2099	4,90	1,33	A+++	6,08	3,70	851	3,70	0
2,97	9,89	11,91	2,99	9,10	13,08	95	A++	7,88	9,00	400	A+	4,20	6,23	2077	4,91	1,32	A+++	6,00	3,90			

Combinatietabellen

Binneneunit	Koelcapaciteit [kW]				Totale koelcapaciteit [kW]			Opgenomen vermogen koelen [kW]			Totale stroom koelen [A]			Verwarmingscapaciteit [kW]				Totale verwarmingscapaciteit [kW]		
	Kamer A	Kamer B	Kamer C	Kamer D	Min.	Nom.	Max.	Min.	Nom.	Max.	Min.	Nom.	Max.	Kamer A	Kamer B	Kamer C	Kamer D	Min.	Nom.	Max.
2,0+2,0+2,0+2,5	1,88	1,88	1,88	2,35	2,46	8,00	8,42	0,52	2,04	2,23	2,26	2,26	2,26	2,82	2,94	9,60	10,93	0,49	2,35	2,42
2,0+2,0+2,0+3,5	1,68	1,68	1,68	2,95	2,58	8,00	8,80	0,55	2,03	2,41	2,02	2,02	2,02	3,54	3,21	9,60	11,15	0,53	2,22	2,49
2,0+2,0+2,0+4,2	1,57	1,57	1,57	3,29	2,68	8,00	9,14	0,59	2,03	2,60	1,88	1,88	1,88	3,95	3,41	9,60	11,16	0,55	2,21	2,49
2,0+2,0+2,0+5,0	1,45	1,45	1,45	3,64	2,79	8,00	9,39	0,59	1,99	2,67	1,75	1,75	1,75	4,36	3,62	9,60	11,29	0,56	2,14	2,50
2,0+2,0+2,0+6,0	1,33	1,33	1,33	4,00	2,93	8,00	9,63	0,63	1,98	2,80	1,60	1,60	1,60	4,80	3,90	9,60	11,53	0,55	2,06	2,43
2,0+2,0+2,0+7,1	1,22	1,22	1,22	4,34	3,08	8,00	9,74	0,63	1,98	2,87	1,47	1,47	1,47	5,20	4,20	9,60	11,56	0,61	2,05	2,42
2,0+2,0+2,5+2,5	1,73	1,73	2,17	2,17	2,52	7,80	8,67	0,55	1,94	2,35	2,13	2,13	2,67	2,67	3,07	9,60	11,14	0,51	2,22	2,50
2,0+2,0+2,5+3,5	1,60	1,60	2,00	2,80	2,65	8,00	9,04	0,55	2,03	2,54	1,92	1,92	2,40	3,36	3,35	9,60	11,15	0,55	2,22	2,49
2,0+2,0+2,5+4,2	1,50	1,50	1,87	3,14	2,75	8,00	9,26	0,59	2,03	2,66	1,79	1,79	2,24	3,77	3,54	9,60	11,16	0,56	2,21	2,49
2,0+2,0+2,5+5,0	1,39	1,39	1,74	3,48	2,86	8,00	9,51	0,59	1,98	2,74	1,67	1,67	2,09	4,17	3,76	9,60	11,29	0,58	2,14	2,50
2,0+2,0+2,5+6,0	1,28	1,28	1,60	3,84	3,00	8,00	9,74	0,63	1,98	2,87	1,54	1,54	1,92	4,61	4,04	9,60	11,53	0,57	2,06	2,43
2,0+2,0+2,5+7,1	1,18	1,18	1,47	4,18	3,15	8,00	9,86	0,66	1,98	2,94	1,41	1,41	1,76	5,01	4,35	9,60	11,56	0,63	2,05	2,42
2,0+2,0+3,5+3,5	1,45	1,45	2,55	2,55	2,79	8,00	9,18	0,59	2,00	2,60	1,75	1,75	3,05	3,05	3,62	9,60	11,16	0,58	2,21	2,49
2,0+2,0+3,5+4,2	1,37	1,37	2,39	2,87	2,89	8,00	9,51	0,62	2,00	2,79	1,64	1,64	2,87	3,45	3,81	9,60	11,17	0,60	2,26	2,49
2,0+2,0+3,5+5,0	1,28	1,28	2,24	3,20	3,00	8,00	9,70	0,63	1,98	2,86	1,54	1,54	2,69	3,84	4,04	9,60	11,29	0,63	2,13	2,49
2,0+2,0+3,5+6,0	1,19	1,19	2,07	3,56	3,13	8,00	9,77	0,66	1,95	2,87	1,42	1,42	2,49	4,27	4,31	9,60	11,53	0,63	2,06	2,42
2,0+2,0+4,2+4,2	1,29	1,29	2,71	2,71	2,98	8,00	9,57	0,62	2,00	2,88	1,55	1,55	3,25	3,25	4,01	9,60	11,18	0,62	2,25	2,48
2,0+2,0+4,2+5,0	1,21	1,21	2,55	3,03	3,09	8,00	9,71	0,65	1,98	2,86	1,45	1,45	3,05	3,64	4,23	9,60	11,30	0,65	2,16	2,49
2,0+2,0+4,2+6,0	1,13	1,13	2,37	3,38	3,38	8,00	9,88	0,57	1,95	2,94	1,35	1,35	2,84	4,06	4,51	9,60	11,54	0,66	2,06	2,42
2,0+2,0+5,0+5,0	1,14	1,14	2,86	2,86	3,20	8,00	9,87	0,65	1,94	2,88	1,37	1,37	3,43	3,43	4,45	9,60	11,44	0,68	2,09	2,46
2,0+2,5+2,5+2,5	1,68	2,11	2,11	2,11	2,58	8,00	8,90	0,55	2,04	2,47	2,02	2,53	2,53	2,53	3,21	9,60	11,14	0,53	2,22	2,50
2,0+2,5+2,5+3,5	1,52	1,90	1,90	2,67	2,72	8,00	9,27	0,59	2,03	2,66	1,83	2,29	2,29	3,20	3,49	9,60	11,15	0,56	2,22	2,49
2,0+2,5+2,5+4,2	1,43	1,79	1,79	3,00	2,82	8,00	9,49	0,59	2,03	2,79	1,71	2,14	2,14	3,60	3,68	9,60	11,16	0,58	2,26	2,49
2,0+2,5+2,5+5,0	1,33	1,67	1,67	3,33	2,93	8,00	9,62	0,63	1,98	2,80	1,60	2,00	2,00	4,00	3,90	9,60	11,29	0,61	2,18	2,50
2,0+2,5+2,5+6,0	1,23	1,54	1,54	3,69	3,06	8,00	9,75	0,63	1,98	2,87	1,48	1,85	1,85	4,43	4,17	9,60	11,53	0,61	2,06	2,43
2,0+2,5+2,5+7,1	1,13	1,42	1,42	4,03	3,38	8,00	9,87	0,57	1,98	2,94	1,36	1,70	1,70	4,83	4,48	9,60	11,56	0,65	2,05	2,42
2,0+2,5+3,5+3,5	1,39	1,74	2,43	2,43	2,86	8,00	9,41	0,62	2,00	2,73	1,67	2,09	2,92	2,92	3,76	9,60	11,16	0,60	2,25	2,49
2,0+2,5+3,5+4,2	1,31	1,64	2,30	2,75	2,95	8,00	9,47	0,62	2,00	2,85	1,57	1,97	2,75	3,30	3,96	9,60	11,17	0,62	2,24	2,49
2,0+2,5+3,5+5,0	1,23	1,54	2,15	3,08	3,06	8,00	9,71	0,65	1,98	2,86	1,48	1,85	2,58	3,69	4,17	9,60	11,29	0,65	2,16	2,49
2,0+2,5+3,5+6,0	1,14	1,43	2,00	3,43	3,20	8,00	9,89	0,66	1,95	2,94	1,37	1,71	2,40	4,11	4,45	9,60	11,53	0,66	2,06	2,42
2,0+2,5+4,2+4,2	1,24	1,55	2,60	2,60	3,05	8,00	9,58	0,65	2,00	2,88	1,49	1,86	3,13	3,13	4,15	9,60	11,18	0,65	2,23	2,48
2,0+2,5+4,2+5,0	1,17	1,46	2,45	2,92	3,16	8,00	9,72	0,65	1,98	2,89	1,40	1,75	2,94	3,50	4,37	9,60	11,30	0,67	2,15	2,49
2,0+2,5+5,0+5,0	1,10	1,38	2,76	2,76	3,40	8,00	9,88	0,57	1,94	2,88	1,32	1,66	3,31	3,31	4,59	9,60	11,44	0,70	2,12	2,46
2,0+3,5+3,5+3,5	1,28	2,24	2,24	2,24	3,00	8,00	9,44	0,62	1,99	2,73	1,54	2,69	2,69	2,69	4,04	9,60	11,17	0,65	2,11	2,49
2,0+3,5+3,5+4,2	1,21	2,12	2,12	2,55	3,09	8,00	9,50	0,65	1,99	2,85	1,45	2,55	2,55	3,05	4,23	9,60	11,18	0,67	2,25	2,48
2,0+3,5+3,5+5,0	1,14	2,00	2,00	2,86	3,20	8,00	9,74	0,65	1,95	2,90	1,37	2,40	2,40	3,43	4,45	9,60	11,30	0,70	2,16	2,49
2,0+3,5+4,2+4,2	1,15	2,01	2,42	2,42	3,36	8,00	9,51	0,57	1,99	2,89	1,38	2,42	2,90	2,90	4,43	9,60	11,18	0,71	2,23	2,48
2,5+2,5+2,5+2,5	2,00	2,00	2,00	2,00	2,65	8,00	9,03	0,55	2,03	2,53	2,40	2,40	2,40	2,40	3,35	9,60	11,14	0,55	2,22	2,50
2,5+2,5+2,5+3,5	1,82	1,82	1,82	2,55	2,79	8,00	9,33	0,59	2,03	2,65	2,18	2,18	2,18	3,05	3,62	9,60	11,15	0,58	2,26	2,49
2,5+2,5+2,5+4,2	1,71	1,71	1,71	2,87	2,89	8,00	9,55	0,62	2,00	2,84	2,05	2,05	2,05	3,45	3,81	9,60	11,16	0,60	2,25	2,49
2,5+2,5+2,5+5,0	1,60	1,60	1,60	3,20	3,00	8,00	9,69	0,63	1,98	2,86	1,92	1,92	1,92	3,84	4,04	9,60	11,29	0,63	2,16	2,50
2,5+2,5+2,5+6,0	1,48	1,48	1,48	3,56	3,13	8,00	9,87	0,66	1,98	2,94	1,78	1,78	1,78	4,27	4,31	9,60	11,53	0,64	2,06	2,43
2,5+2,5+3,5+3,5	1,67	1,67	2,33	2,33	2,93	8,00	9,31	0,62	2,00	2,67	2,00	2,00	2,80	2,80	3,90	9,60	11,16	0,63	2,25	2,49
2,5+2,5+3,5+4,2	1,57	1,57	2,20	2,65	3,02	8,00	9,48	0,62	2,00	2,85	1,89	1,89	2,65	3,17	4,09	9,60	11,17	0,65	2,23	2,49
2,5+2,5+3,5+5,0	1,48	1,48	2,07	2,96	3,13	8,00	9,72	0,65	1,95	2,89	1,78	1,78	2,49	3,56	4,31	9,60	11,29	0,67	2,15	2,49
2,5+2,5+3,5+6,0	1,38	1,38	1,93	3,31	3,38	8,00	9,90	0,57	1,95	2,94	1,66	1,66	2,32	3,97	4,59	9,60	11,53	0,68	2,06	2,42
2,5+2,5+4,2+4,2	1,49	1,49	2,51	2,51	3,12	8,00	9,49	0,65	2,00	2,89	1,79	1,79	3,01	3,01	4,28	9,60	11,18	0,67	2,21	2,48
2,5+2,5+4,2+5,0	1,41	1,41	2,37	2,82	3,38	8,00	9,73	0,57	1,95	2,89	1,69	1,69	2,84	3,38	4,51	9,60	11,30	0,71	2,13	2,49
2,5+3,5+3,5+3,5	1,54	2,15	2,15	2,15	3,06	8,00	9,50	0,65	1,99	2,78	1,85	2,58	2,58	2,58	4,17	9,60	11,17	0,67	2,25	2,49
2,5+3,5+3,5+4,2	1,46	2,04	2,04	2,45	3,16	8,00	9,51	0,65	1,99	2,89	1,75	2,45	2,45	2,94	4,37	9,60	11,18	0,70	2,23	2,48
2,5+3,5+3,5+5,0	1,38	1,93	1,93	2,76	3,38	8,00	9,75	0,57	1,95	2,86	1,66	2,32	2,32	3,31	4,59	9,60	11,30	0,71	2,15	2,49
2,5+3,5+4,2+4,2	1,39	1,94	2,33	2,33	3,36	8,00	9,52	0,57	1,99	2,89	1,67	2,33	2,80	2,80	4,56	9,60	11,18	0,73	2,21	2,48
3,5+3,5+3,5+3,5	2,00	2,00	2,00	2,00	3,36	8,00	9,54	0,57	1,99	2,85	2,40	2,40	2,40	2,40	4,45	9,60	11,18	0,71	2,19	2,48

Minimaal 2 binneneunits aansluiten op deze buitenunit. Bovenstaande waarden zijn geldig voor de combinaties met CTXM-R, FTXM-R en FTXA. Voor andere combinaties dient u de energielabel generator te raadplegen.

Opgenomen vermogen verwarmen [kW]			Totale stroom verwarmen [A]			Vermogens-factor [%]	Seizoensgegevens koelen				Seizoensgegevens verwarmen (gemiddeld klimaat)						Seizoensgegevens verwarmen (warm klimaat)					
Min.	Nom.	Max.	Min.	Nom.	Max.		label	SEER	Ontwerp-capaciteit	AEC	label	SCOP	Ontwerp-capaciteit	AEC	Opgegeven capaciteit bij -10°C	Capaciteit back-upverwarming bij -10°C	label	SCOP	Ontwerp-capaciteit	AEC	Opgegeven capaciteit bij +2°C	Capaciteit back-upverwarming bij +2°C
2,24	10,76	11,08	2,36	9,40	10,30	95	A++	8,09	8,00	346	A+	4,57	6,23	1908	4,87	1,36	A+++	6,49	3,50	755	3,50	0
2,41	10,17	11,91	2,53	9,40	11,10	95	A++	8,09	8,00	346	A++	4,60	6,23	1894	4,87	1,36	A+++	6,48	3,60	778	3,60	0
2,50	10,12	11,91	2,69	9,40	11,90	95	A++	7,69	8,50	387	A++	4,62	6,23	1887	4,88	1,35	A+++	6,48	3,60	778	3,60	0
2,58	9,80	11,95	2,69	9,10	12,30	95	A++	7,62	9,00	413	A++	4,69	6,23	1857	4,89	1,34	A+++	6,41	3,80	830	3,80	0
2,54	9,43	11,60	2,86	9,10	12,90	95	A++	7,65	9,00	412	A++	4,73	6,23	1843	4,89	1,34	A+++	6,37	3,80	835	3,80	0
2,80	9,39	11,56	2,86	9,10	13,20	95	A++	7,71	9,00	409	A++	4,77	6,23	1829	4,90	1,33	A+++	6,34	3,90	862	3,90	0
2,32	10,17	11,95	2,53	8,90	10,80	95	A++	8,20	7,80	333	A+	4,59	6,23	1900	4,87	1,36	A+++	6,50	3,60	775	3,60	0
2,50	10,17	11,91	2,53	9,30	11,70	95	A++	7,74	8,50	385	A++	4,62	6,23	1887	4,88	1,35	A+++	6,49	3,60	776	3,60	0
2,58	10,12	11,91	2,69	9,30	12,30	95	A++	7,68	9,00	410	A++	4,64	6,23	1880	4,88	1,35	A+++	6,49	3,70	798	3,70	0
2,67	9,80	11,95	2,69	9,10	12,60	95	A++	7,68	9,00	411	A++	4,71	6,23	1850	4,89	1,34	A+++	6,42	3,80	828	3,80	0
2,62	9,43	11,60	2,86	9,10	13,20	95	A++	7,69	9,00	410	A++	4,75	6,23	1836	4,90	1,33	A+++	6,39	3,90	855	3,90	0
2,88	9,39	11,56	3,03	9,10	13,50	95	A++	7,71	9,00	409	A++	4,78	6,23	1822	4,90	1,33	A+++	6,35	3,90	860	3,90	0
2,67	10,12	11,91	2,69	9,20	12,00	95	A++	7,74	9,00	407	A++	4,64	6,23	1879	4,88	1,35	A+++	6,51	3,70	796	3,70	0
2,75	10,35	11,91	2,82	9,20	12,90	95	A++	7,74	9,00	407	A++	4,65	6,23	1872	4,88	1,35	A+++	6,50	3,70	796	3,70	0
2,88	9,75	11,91	2,86	9,10	13,08	95	A++	7,74	9,00	407	A++	4,73	6,23	1843	4,90	1,33	A+++	6,44	3,80	826	3,80	0
2,88	9,43	11,56	3,03	9,00	13,20	95	A++	7,76	9,00	406	A++	4,77	6,23	1829	4,90	1,33	A+++	6,40	3,90	853	3,90	0
2,84	10,30	11,86	2,82	9,20	13,19	95	A++	7,75	9,00	407	A++	4,67	6,23	1865	4,89	1,34	A+++	6,52	3,70	795	3,70	0
2,97	9,89	11,91	2,99	9,10	13,08	95	A++	7,75	9,00	407	A++	4,75	6,23	1835	4,90	1,33	A+++	6,45	3,90	847	3,90	0
3,01	9,43	11,56	2,70	9,00	13,60	95	A++	7,76	9,00	406	A++	4,78	6,23	1822	4,90	1,33	A+++	6,41	3,90	851	3,90	0
3,10	9,57	11,73	2,99	8,90	13,30	95	A++	7,75	9,00	407	A++	4,77	6,23	1828	4,90	1,33	A+++	6,46	3,90	845	3,90	0
2,41	10,17	11,95	2,53	9,40	11,40	95	A++	8,21	8,00	341	A++	4,61	6,23	1892	4,88	1,35	A+++	6,48	3,60	777	3,60	0
2,58	10,17	11,91	2,69	9,30	12,30	95	A++	7,75	8,70	393	A++	4,64	6,23	1879	4,89	1,34	A+++	6,47	3,70	800	3,70	0
2,67	10,35	11,91	2,69	9,30	12,90	95	A++	7,75	9,00	407	A++	4,66	6,23	1872	4,90	1,33	A+++	6,47	3,70	801	3,70	0
2,80	9,98	11,95	2,86	9,10	12,90	95	A++	7,74	9,00	407	A++	4,73	6,23	1842	4,91	1,32	A+++	6,40	3,80	831	3,80	0
2,80	9,43	11,60	2,86	9,10	13,20	95	A++	7,76	9,00	406	A++	4,77	6,23	1828	4,91	1,32	A+++	6,36	3,90	858	3,90	0
2,97	9,39	11,56	2,70	9,10	13,50	95	A++	7,77	9,00	405	A++	4,80	6,23	1815	4,91	1,32	A+++	6,32	4,00	885	4,00	0
2,75	10,30	11,91	2,82	9,20	12,50	95	A++	7,78	9,00	405	A++	4,66	6,23	1871	4,90	1,33	A+++	6,49	3,70	799	3,70	0
2,84	10,26	11,91	2,82	9,20	13,04	95	A++	7,79	9,00	405	A++	4,67	6,23	1864	4,90	1,33	A+++	6,48	3,70	799	3,70	0
2,97	9,89	11,91	2,99	9,10	13,08	95	A++	7,78	9,00	405	A++	4,75	6,23	1835	4,91	1,32	A+++	6,41	3,90	851	3,90	0
3,01	9,43	11,56	3,03	9,00	13,60	95	A++	7,79	9,00	404	A++	4,79	6,23	1821	4,91	1,32	A+++	6,38	3,90	856	3,90	0
2,97	10,21	11,86	2,99	9,20	13,19	95	A++	7,79	9,00	405	A++	4,69	6,23	1857	4,90	1,33	A+++	6,50	3,70	797	3,70	0
3,05	9,84	11,91	2,99	9,10	13,24	95	A++	7,79	9,00	405	A++	4,77	6,23	1828	4,91	1,32	A+++	6,43	3,90	850	3,90	0
3,18	9,71	11,73	2,70	8,90	13,30	95	A++	7,79	9,00	404	A++	4,79	6,23	1821	4,92	1,31	A+++	6,44	3,90	848	3,90	0
2,97	9,66	11,91	2,82	9,20	12,60	95	A++	7,81	9,00	404	A++	4,66	6,23	1869	4,93	1,30	A+++	6,49	3,70	798	3,70	0
3,05	10,30	11,86	2,99	9,20	13,05	95	A++	7,81	9,00	404	A++	4,68	6,23	1862	4,93	1,30	A+++	6,49	3,70	799	3,70	0
3,18	9,89	11,91	2,99	9,00	13,25	95	A++	7,80	9,00	404	A++	4,76	6,23	1833	4,94	1,29	A+++	6,41	3,90	851	3,90	0
3,27	10,21	11,86	2,70	9,20	13,22	95	A++	7,82	9,00	403	A++	4,70	6,23	1855	4,94	1,29	A+++	6,50	3,70	797	3,70	0
2,50	10,17	11,95	2,53	9,40	11,70	95	A++	7,78	8,50	382	A++	4,62	6,23	1884	4,89	1,34	A+++	6,49	3,60	777	3,60	0
2,67	10,35	11,91	2,69	9,30	12,11	95	A++	7,76	9,00	406	A++	4,66	6,23	1871	4,90	1,33	A+++	6,47	3,70	800	3,70	0
2,75	10,30	11,91	2,82	9,20	13,02	95	A++	7,76	9,00	406	A++	4,68	6,23	1864	4,90	1,33	A+++	6,47	3,70	800	3,70	0
2,88	9,89	11,95	2,86	9,10	13,07	95	A++	7,76	9,00	406	A++	4,75	6,23	1835	4,91	1,32	A+++	6,40	3,90	853	3,90	0
2,93	9,43	11,60	3,03	9,10	13,50	95	A++	7,77	9,00	405	A++	4,79	6,23	1821	4,92	1,31	A+++	6,36	3,90	858	3,90	0
2,88	10,30	11,91	2,82	9,20	12,30	95	A++	7,77	9,00	406	A++	4,68	6,23	1863	4,90	1,33	A+++	6,49	3,70	798	3,70	0
2,97	10,21	11,91	2,82	9,20	13,04	95	A++	7,77	9,00	406	A++	4,69	6,23	1857	4,91	1,32	A+++	6,48	3,70	799	3,70	0
3,05	9,84	11,91	2,99	9,00	13,25	95	A++	7,76	9,00	406	A++	4,77	6,23	1828	4,92	1,31	A+++	6,41	3,90	851	3,90	0
3,10	9,43	11,56	2,70	9,00	13,60	95	A++	7,78	9,00	405	A++	4,80	6,23	1814	4,92	1,31	A+++	6,38	4,00	878	4,00	0
3,05	10,12	11,86	2,99	9,20	13,21	95	A++	7,78	9,00	405	A++	4,71	6,23	1850	4,91	1,32	A+++	6,50	3,80	819	3,80	0
3,27	9,75	11,91	2,70	9,00	13,25	95	A++	7,77	9,00	406	A++	4,79	6,23	1821	4,92	1,31	A+++	6,43	3,90	849	3,90	0
3,05	10,30	11,91	2,99	9,20	12,74	95	A++	7,79	9,00	405	A++	4,68	6,23	1861	4,94	1,29	A+++	6,49	3,70	798	3,70	0
3,18	10,21	11,86	2,99	9,20	13,22	95	A++	7,79	9,00	404	A++	4,70	6,23	1855	4,94	1,29	A+++	6,49	3,70	798	3,70	0
3,27	9,84	11,91	2,70	9,00	13,09	95	A++	7,79	9,00	405	A++	4,77	6,23	1826	4,95	1,28	A+++	6,42	3,90	851	3,90	0
3,36	10,12	11,86	2,70	9,20	13,22	95	A++	7,80	9,00	404	A++	4,72	6,23	1847	4,94	1,29	A+++	6,50	3,80	819	3,80	0
3,27	10,03	11,86	2,70	9,10	13,07	95	A++	7,80	9,00	404	A++	4,75	6,23	1835	4,94	1,29	A+++	6,51	3,70	796	3,70	0

Combinatietabellen

Binneneenheid	Koelcapaciteit [kW]					Totale koelcapaciteit [kW]			Opgenomen vermogen koelen [kW]			Totale stroom koelen [A]			Verwarmingcapaciteit [kW]					Totale verwarmingcapaciteit [kW]		
	Kamer A	Kamer B	Kamer C	Kamer D	Kamer E	Min.	Nom.	Max.	Min.	Nom.	Max.	Min.	Nom.	Max.	Kamer A	Kamer B	Kamer C	Kamer D	Kamer E	Min.	Nom.	Max.
1,5	1,80	---	---	---	---	1,78	1,80	2,99	0,43	0,33	0,57	1,95	1,60	2,70	1,90	---	---	---	---	1,28	1,90	4,15
2,0	2,00	---	---	---	---	1,86	2,00	3,11	0,44	0,37	0,61	2,00	1,70	2,80	2,49	---	---	---	---	1,33	2,49	4,37
2,5	2,50	---	---	---	---	1,98	2,50	3,69	0,48	0,46	0,80	2,18	2,20	3,70	3,11	---	---	---	---	1,39	3,11	4,84
3,5	3,50	---	---	---	---	2,03	3,50	4,94	0,50	0,74	1,29	2,31	3,40	6,00	4,36	---	---	---	---	1,51	4,36	5,31
4,2	4,20	---	---	---	---	2,06	4,20	5,33	0,51	0,98	1,42	2,35	4,50	6,52	5,23	---	---	---	---	1,56	5,23	6,16
5,0	5,00	---	---	---	---	2,20	5,00	6,03	0,48	1,24	1,71	2,18	5,70	7,84	6,21	---	---	---	---	1,94	6,21	7,75
6,0	6,00	---	---	---	---	2,31	6,00	6,80	0,49	1,69	2,18	2,22	7,80	10,00	7,46	---	---	---	---	2,23	7,46	9,05
7,1	7,10	---	---	---	---	2,43	7,10	7,58	0,51	2,42	2,83	2,35	11,10	13,00	8,82	---	---	---	---	2,55	8,82	9,38
1,5+1,5	1,50	1,50	---	---	---	2,01	3,00	4,79	0,42	0,54	0,99	1,94	2,50	4,51	1,85	1,85	---	---	---	1,51	3,70	7,45
1,5+2,0	1,50	2,00	---	---	---	2,03	3,50	4,96	0,46	0,67	1,07	2,11	3,10	4,88	1,84	2,46	---	---	---	1,57	4,30	7,83
1,5+2,5	1,50	2,50	---	---	---	2,09	4,00	5,28	0,42	0,81	1,20	1,94	3,80	5,48	1,84	3,06	---	---	---	1,72	4,90	8,02
1,5+3,5	1,50	3,50	---	---	---	2,20	5,00	6,17	0,42	1,11	1,53	1,94	5,10	6,99	1,83	4,27	---	---	---	2,02	6,10	8,57
1,5+4,2	1,50	4,20	---	---	---	2,27	5,70	6,59	0,42	1,37	1,76	1,94	6,30	8,10	1,84	5,16	---	---	---	2,23	7,00	8,92
1,5+5,0	1,50	5,00	---	---	---	2,36	6,50	7,20	0,46	1,65	1,97	2,11	7,60	9,10	1,85	6,15	---	---	---	2,48	8,00	10,45
1,5+6,0	1,50	6,00	---	---	---	2,48	7,50	7,81	0,50	2,12	2,29	2,27	9,80	10,60	1,80	7,20	---	---	---	2,77	9,00	10,65
1,5+7,1	1,40	6,60	---	---	---	2,64	8,00	8,51	0,52	2,40	2,76	2,40	11,10	12,70	1,74	8,26	---	---	---	3,09	10,00	10,67
2,0+2,0	2,00	2,00	---	---	---	2,09	4,00	5,45	0,46	0,81	1,29	2,11	3,80	6,00	2,45	2,45	---	---	---	1,72	4,90	8,02
2,0+2,5	2,00	2,50	---	---	---	2,14	4,50	5,91	0,46	0,97	1,47	2,11	4,50	6,80	2,44	3,06	---	---	---	1,88	5,50	8,19
2,0+3,5	2,00	3,50	---	---	---	2,25	5,50	6,58	0,46	1,31	1,76	2,11	6,00	8,10	2,44	4,26	---	---	---	2,17	6,70	8,74
2,0+4,2	2,00	4,20	---	---	---	2,33	6,20	6,98	0,46	1,59	1,96	2,11	7,30	9,00	2,45	5,15	---	---	---	2,39	7,60	9,10
2,0+5,0	2,00	5,00	---	---	---	2,42	7,00	7,49	0,46	1,89	2,13	2,11	8,70	9,80	2,43	6,07	---	---	---	2,62	8,50	10,63
2,0+6,0	1,88	5,63	---	---	---	2,55	7,50	8,16	0,50	2,12	2,52	2,27	9,80	11,60	2,33	6,98	---	---	---	2,92	9,30	10,82
2,0+7,1	1,76	6,24	---	---	---	2,71	8,00	8,67	0,52	2,40	2,88	2,40	11,10	13,20	2,20	7,80	---	---	---	3,23	10,00	10,92
2,5+2,5	2,50	2,50	---	---	---	2,20	5,00	6,34	0,42	1,12	1,66	1,94	5,20	7,70	3,05	3,05	---	---	---	2,02	6,10	8,56
2,5+3,5	2,50	3,50	---	---	---	2,31	6,00	6,79	0,46	1,50	1,86	2,11	6,90	8,60	3,04	4,26	---	---	---	2,33	7,30	9,12
2,5+4,2	2,50	4,20	---	---	---	2,39	6,70	7,27	0,46	1,81	2,12	2,11	8,30	9,80	3,06	5,14	---	---	---	2,54	8,20	9,38
2,5+5,0	2,50	5,00	---	---	---	2,48	7,50	7,88	0,49	2,13	2,35	2,23	9,80	10,80	3,00	6,00	---	---	---	2,77	9,00	10,72
2,5+6,0	2,35	5,65	---	---	---	2,63	8,00	8,43	0,52	2,40	2,70	2,40	11,10	12,40	2,82	6,78	---	---	---	3,06	9,60	10,92
2,5+7,1	2,21	6,29	---	---	---	2,79	8,50	8,69	0,55	2,75	2,88	2,53	12,60	13,20	2,60	7,40	---	---	---	3,38	10,00	11,20
3,5+3,5	3,50	3,50	---	---	---	2,42	7,00	7,49	0,49	1,95	2,23	2,23	9,00	10,30	4,25	4,25	---	---	---	2,62	8,50	9,57
3,5+4,2	3,50	4,20	---	---	---	2,51	7,70	7,85	0,49	2,37	2,45	2,23	10,90	11,30	4,09	4,91	---	---	---	2,83	9,00	10,18
3,5+5,0	3,29	4,71	---	---	---	2,63	8,00	8,02	0,52	2,40	2,41	2,40	11,00	11,10	3,91	5,59	---	---	---	3,06	9,50	10,94
3,5+6,0	2,95	5,05	---	---	---	2,77	8,00	8,65	0,55	2,39	2,82	2,53	11,00	13,00	3,68	6,32	---	---	---	3,35	10,00	11,18
3,5+7,1	2,97	6,03	---	---	---	2,93	9,00	8,68	0,59	2,94	2,82	2,69	13,50	13,00	3,30	6,70	---	---	---	3,66	10,00	11,21
4,2+4,2	4,00	4,00	---	---	---	2,61	8,00	7,86	0,52	2,55	2,45	2,36	11,70	11,30	4,75	4,75	---	---	---	3,03	9,50	9,99
4,2+5,0	3,65	4,35	---	---	---	2,73	8,00	8,21	0,55	2,40	2,52	2,53	11,00	11,60	4,57	5,43	---	---	---	3,26	10,00	10,95
4,2+6,0	3,50	5,00	---	---	---	2,88	8,50	8,67	0,55	2,65	2,82	2,53	12,20	13,00	4,12	5,88	---	---	---	3,55	10,00	11,19
4,2+7,1	3,35	5,65	---	---	---	3,04	9,00	8,85	0,59	2,94	2,95	2,69	13,50	13,60	3,72	6,28	---	---	---	3,87	10,00	11,21
5,0+5,0	4,25	4,25	---	---	---	2,85	8,50	8,37	0,55	2,59	2,48	2,53	11,90	11,40	5,00	5,00	---	---	---	3,49	10,00	11,12
5,0+6,0	4,09	4,91	---	---	---	2,99	9,00	8,85	0,59	2,90	2,78	2,69	13,30	12,80	4,55	5,45	---	---	---	3,77	10,00	11,32
5,0+7,1	3,72	5,28	---	---	---	3,25	9,00	9,12	0,57	2,90	2,97	2,70	13,30	13,70	4,13	5,87	---	---	---	4,09	10,00	11,35
6,0+6,0	4,50	4,50	---	---	---	3,25	9,00	9,46	0,57	2,89	3,23	2,70	13,30	14,90	5,00	5,00	---	---	---	4,07	10,00	11,14
6,0+7,1	4,12	4,88	---	---	---	3,41	9,00	9,48	0,60	2,79	3,23	2,80	12,80	14,90	4,58	5,42	---	---	---	4,39	10,00	11,17
7,1+7,1	4,50	4,50	---	---	---	3,57	9,00	9,51	0,64	2,79	3,24	3,00	12,80	14,90	5,00	5,00	---	---	---	4,70	10,00	11,20
1,5+1,5+1,5	1,50	1,50	1,50	---	---	2,14	4,50	6,40	0,43	0,87	1,37	1,98	4,00	6,25	1,83	1,83	1,83	---	---	1,88	5,50	9,97
1,5+1,5+2,0	1,50	1,50	2,00	---	---	2,20	5,00	6,56	0,43	1,01	1,46	1,98	4,70	6,66	1,83	1,83	2,44	---	---	2,02	6,10	10,15
1,5+1,5+2,5	1,50	1,50	2,50	---	---	2,25	5,50	6,72	0,43	1,16	1,55	1,98	5,30	7,08	1,83	1,83	3,05	---	---	2,17	6,70	10,23
1,5+1,5+3,5	1,50	1,50	3,50	---	---	2,36	6,50	7,20	0,46	1,51	1,78	2,11	7,00	8,20	1,85	1,85	4,31	---	---	2,48	8,00	10,34
1,5+1,5+4,2	1,50	1,50	4,20	---	---	2,44	7,20	7,67	0,46	1,78	1,99	2,11	8,20	9,20	1,81	1,81	5,08	---	---	2,68	8,70	10,34
1,5+1,5+5,0	1,41	1,41	4,69	---	---	2,55	7,50	8,18	0,50	1,87	2,17	2,27	8,60	10,00	1,74	1,74	5,81	---	---	2,92	9,30	10,51
1,5+1,5+6,0	1,33	1,33	5,33	---	---	2,70	8,00	8,75	0,53	2,09	2,46	2,44	9,60	11,30	1,58	1,58	6,33	---	---	3,20	9,50	11,14
1,5+1,5+7,1	1,26	1,26	5,98	---	---	2,86	8,50	9,26	0,56	2,33	2,77	2,57	10,70	12,70	1,49	1,49	7,03	---	---	3,52	10,00	11,18
1,5+2,0+2,0	1,50	2,00	2,00	---	---	2,25	5,50	6,58	0,46	1,16	1,52	2,11	5,40	6,94	1,83	2,44	2,44	---	---	2,17	6,70	10,31
1,5+2,0+2,5	1,50	2,00	2,50	---	---	2,31	6,00	6,89	0,43	1,33	1,65	1,98	6,10	7,54	1,83	2,43	3,04	---	---	2,33	7,30	10,41
1,5+2,0+3,5	1,50	2,00	3,50	---	---	2,42	7,00	7,55	0,46	1,71	1,94	2,11	7,90	8,90	1,82	2,43	4,25	---	---	2,63	8,50	10,50
1,5+2,0+4,2	1,50	2,00	4,20	---	---	2,51	7,70	8,00	0,50	2,02	2,16	2,27	9,30	9,90	1,75	2,34	4,91	---	---	2,83	9,00	10,51
1,5+2,0+5,0	1,41	1,88	4,71	---	---	2,63	8,00	8,50	0,50	2,09	2,34	2,27	9,60	10,80	1,76	2,35	5,88	---	---	3,06	10,00	10,93
1,5+2,0+6,0	1,26	1,68	5,05	---	---	2,77	8,00	9,05	0,53	2,09	2,64	2,44	9,60	12,20	1,58	2,11	6,32	---	---	3,35	10,00	11,14
1,5+2,0+7,1	1,27	1,70	6,03	---	---	2,93	9,00	9,36	0,56	2,62	2,83	2,57	12,00	13,00	1,42	1,89	6,70	---	---	3,66	10,00	11,18
1,5+2,5+2,5	1,50	2,50	2,50	---	---	2,36	6,50	7,18	0,46	1,51	1,78	2,11	7,00	8,20	1,85	3,08	3,08	---	---	2,48	8,00	10,52
1,5+2,5+3,5	1,50	2,50	3,50	---	---	2,48	7,50	7,90	0,50	1,92	2,10	2,27	8,80	9,70	1,80	3,00	4,20	---	---	2,77	9,00	10,63
1,5+2,5+4,2	1,46	2,44	4,10	---	---	2,58	8,00	8,33	0,50	2,												

Opgenomen vermogen verwarmen [kW]			Totale stroom verwarmen [A]			Vermogens-factor [%]	Seizoensgegevens koelen				Seizoensgegevens verwarmen (gemiddeld klimaat)						Seizoensgegevens verwarmen (warm klimaat)					
Min.	Nom.	Max.	Min.	Nom.	Max.		label	SEER	Ontwerp-capaciteit	AEC	label	SCOP	Ontwerp-capaciteit	AEC	Opgegeven capaciteit bij -10°C	Capaciteit back-upverwarming bij -10°C	label	SCOP	Ontwerp-capaciteit	AEC	Opgegeven capaciteit bij +2°C	Capaciteit back-upverwarming bij +2°C
0,28	0,53	1,31	1,29	2,43	5,98	95	---	---	---	---	---	---	---	---	---	---	---	---	---	---	---	---
0,34	0,67	1,37	1,55	3,05	6,25	95	---	---	---	---	---	---	---	---	---	---	---	---	---	---	---	---
0,36	0,88	1,47	1,64	4,04	6,71	95	---	---	---	---	---	---	---	---	---	---	---	---	---	---	---	---
0,38	1,40	1,93	1,73	6,42	8,84	95	---	---	---	---	---	---	---	---	---	---	---	---	---	---	---	---
0,40	1,63	2,06	1,82	7,45	9,42	95	---	---	---	---	---	---	---	---	---	---	---	---	---	---	---	---
0,47	1,76	2,39	2,13	8,08	10,92	95	---	---	---	---	---	---	---	---	---	---	---	---	---	---	---	---
0,58	2,25	2,86	2,66	10,32	13,09	95	---	---	---	---	---	---	---	---	---	---	---	---	---	---	---	---
0,65	2,81	3,01	2,97	12,88	13,77	95	---	---	---	---	---	---	---	---	---	---	---	---	---	---	---	---
0,37	0,88	1,85	1,68	4,03	8,47	95	A++	7,08	3,00	149	A	3,87	3,50	1264	3,18	0,32	A+++	5,85	3,90	933	3,90	0
0,35	1,04	2,01	1,59	4,76	9,20	95	A++	7,22	3,50	170	A	3,88	3,50	1262	3,18	0,32	A+++	5,85	3,90	933	3,90	0
0,37	1,20	2,08	1,68	5,50	9,52	95	A++	7,31	4,00	192	A	3,89	3,50	1259	3,19	0,31	A+++	5,85	3,90	932	3,90	0
0,44	1,68	2,37	2,02	7,69	10,85	95	A++	7,45	5,00	235	A	3,91	3,80	1360	3,37	0,43	A+++	5,86	3,90	932	3,90	0
0,42	1,99	2,59	1,94	9,11	11,85	95	A++	7,45	5,70	268	A	3,92	3,80	1357	3,37	0,43	A+++	5,86	4,00	956	4,00	0
0,44	2,17	2,93	2,02	9,94	13,41	95	A++	7,51	6,50	303	A+	4,00	4,50	1573	3,77	0,73	A+++	5,89	4,00	950	4,00	0
0,48	2,47	2,72	2,19	11,31	12,45	95	A++	7,45	7,50	352	A+	4,01	4,50	1570	3,79	0,71	A+++	5,89	4,10	974	4,10	0
0,52	2,90	2,70	2,37	13,28	12,36	95	A++	7,43	8,60	406	A+	4,02	4,50	1567	3,81	0,69	A+++	5,89	4,10	974	4,10	0
0,37	1,19	2,33	1,68	5,45	10,66	95	A++	7,30	4,00	192	A	3,86	3,50	1267	3,19	0,31	A+++	5,85	3,90	933	3,90	0
0,39	1,37	2,34	1,76	6,28	10,71	95	A++	7,35	4,50	215	A	3,87	3,50	1265	3,19	0,31	A+++	5,86	3,90	932	3,90	0
0,47	1,75	2,45	2,15	8,01	11,21	95	A++	7,49	5,50	257	A	3,92	3,80	1355	3,37	0,43	A+++	5,85	4,00	956	4,00	0
0,58	2,04	2,68	2,67	9,34	12,27	95	A++	7,50	6,20	290	A	3,93	3,80	1353	3,38	0,42	A+++	5,86	4,00	956	4,00	0
0,59	2,35	3,02	2,71	10,76	13,82	95	A++	7,52	7,00	326	A+	4,03	4,50	1564	3,77	0,73	A+++	5,89	4,00	951	4,00	0
0,61	2,62	2,72	2,80	12,00	12,45	95	A++	7,48	7,50	351	A+	4,03	4,50	1560	3,79	0,71	A+++	5,89	4,10	975	4,10	0
0,65	2,90	2,93	2,97	13,28	13,41	95	A++	7,49	8,00	374	A+	4,04	4,50	1557	3,81	0,69	A+++	5,89	4,20	999	4,20	0
0,44	1,73	2,38	2,02	7,92	10,89	95	A++	7,46	5,00	235	A	3,88	3,50	1263	3,20	0,30	A+++	5,86	3,90	932	3,90	0
0,56	2,08	2,70	2,58	9,52	12,36	95	A++	7,48	6,00	281	A	3,93	3,80	1352	3,38	0,42	A+++	5,87	4,00	954	4,00	0
0,61	2,35	2,93	2,80	10,76	13,41	95	A++	7,55	6,70	311	A	3,94	3,80	1349	3,38	0,42	A+++	5,87	4,00	953	4,00	0
0,62	2,58	3,11	2,84	11,81	14,23	95	A++	7,46	7,50	352	A+	4,05	4,50	1552	3,78	0,72	A+++	5,90	4,00	948	4,00	0
0,63	2,76	2,79	2,88	12,64	12,77	95	A++	7,49	8,00	374	A+	4,06	4,50	1549	3,80	0,70	A+++	5,90	4,10	972	4,10	0
0,68	2,89	3,18	3,10	13,23	14,55	95	A++	7,47	8,50	398	A+	4,07	4,50	1546	3,82	0,68	A+++	5,90	4,20	996	4,20	0
0,61	2,54	2,90	2,80	11,63	13,27	95	A++	7,53	7,00	326	A+	4,03	4,50	1561	3,77	0,73	A+++	5,90	4,00	949	4,00	0
0,66	2,77	3,25	3,01	12,68	14,87	95	A++	7,48	7,70	360	A+	4,04	4,50	1558	3,77	0,73	A+++	5,90	4,00	949	4,00	0
0,67	2,73	3,15	3,05	12,50	14,42	95	A++	7,46	8,00	375	A+	4,09	5,20	1777	4,17	1,03	A+++	5,96	4,00	939	4,00	0
0,68	2,77	3,16	3,10	12,68	14,46	95	A++	7,47	8,00	375	A+	4,11	5,20	1770	4,19	1,01	A+++	5,96	4,10	963	4,10	0
0,72	2,73	3,08	3,31	12,50	13,78	95	A++	7,35	9,00	429	A+	4,13	5,20	1763	4,21	0,99	A+++	5,96	4,20	986	4,20	0
0,68	2,62	3,25	3,10	12,00	14,87	95	A++	7,42	8,00	377	A+	4,05	4,50	1555	3,77	0,73	A+++	5,90	4,00	948	4,00	0
0,69	2,78	3,21	3,14	12,73	14,69	95	A++	7,41	8,00	378	A+	4,16	5,20	1748	4,17	1,03	A+++	5,96	4,10	962	4,10	0
0,71	2,74	3,15	3,23	12,55	14,42	95	A++	7,38	8,50	404	A+	4,18	5,20	1741	4,19	1,01	A+++	5,96	4,10	962	4,10	0
0,74	2,69	3,07	3,40	12,32	14,05	95	A++	7,35	9,00	429	A+	4,19	5,20	1734	4,21	0,99	A+++	5,96	4,20	986	4,20	0
0,71	2,71	3,13	3,27	12,41	14,32	95	A++	7,49	8,50	397	A+	4,05	6,46	2229	4,87	1,59	A+++	6,04	4,10	950	4,10	0
0,71	2,67	3,05	3,23	12,22	13,96	95	A++	7,54	9,00	418	A+	4,07	6,46	2220	4,89	1,57	A+++	6,04	4,10	950	4,10	0
0,78	2,63	2,83	3,57	12,04	12,95	95	A++	7,55	9,00	417	A+	4,09	6,46	2211	4,91	1,55	A+++	6,04	4,20	973	4,20	0
0,71	2,65	2,80	3,27	12,13	12,81	95	A++	7,55	9,00	418	A+	4,08	6,46	2215	4,90	1,56	A+++	6,04	4,20	973	4,20	0
0,79	2,62	2,79	3,61	12,00	12,77	95	A++	7,56	9,00	417	A+	4,10	6,46	2206	4,91	1,55	A+++	6,04	4,20	973	4,20	0
0,84	2,60	2,78	3,83	11,90	12,72	95	A++	7,56	9,00	417	A+	4,09	6,46	2207	4,93	1,53	A+++	6,04	4,30	997	4,30	0
0,44	1,20	2,28	2,02	5,50	10,43	95	A++	8,03	4,50	197	A+	4,00	4,80	1679	3,97	0,83	A+++	5,78	3,60	871	3,60	0
0,46	1,38	2,36	2,11	6,32	10,80	95	A++	8,10	5,00	217	A+	4,01	4,80	1674	3,98	0,82	A+++	5,77	3,70	897	3,70	0
0,48	1,59	2,39	2,19	7,28	10,94	95	A++	8,32	5,50	232	A+	4,02	4,80	1669	3,98	0,82	A+++	5,76	3,70	899	3,70	0
0,52	2,05	2,51	2,37	9,39	11,49	95	A++	8,33	6,50	273	A+	4,02	5,50	1914	4,38	1,12	A+++	5,79	3,80	919	3,80	0
0,56	2,29	2,51	2,58	10,49	11,49	95	A++	8,29	7,20	304	A+	4,03	5,50	1908	4,39	1,11	A+++	5,78	3,80	921	3,80	0
0,56	2,48	2,61	2,58	11,36	11,95	95	A++	8,22	7,50	320	A+	4,12	6,46	2191	4,93	1,53	A+++	5,76	3,90	947	3,90	0
0,57	2,48	2,80	2,62	11,36	12,81	95	A++	8,16	8,00	344	A+	4,15	6,46	2175	4,95	1,51	A+++	5,72	4,00	979	4,00	0
0,61	2,70	2,79	2,80	12,36	12,77	95	A++	8,09	8,50	368	A+	4,18	6,46	2159	4,97	1,49	A+++	5,68	4,10	1011	4,10	0
0,48	1,60	2,43	2,19	7,33	11,12	95	A++	8,30	5,50	232	A+	4,01	4,80	1672	3,98	0,82	A+++	5,76	3,60	875	3,60	0
0,50	1,77	2,46	2,28	8,11	11,26	95	A++	8,30	6,00	253	A+	4,04	4,80	1663	3,99	0,81	A+++	5,75	3,60	877	3,60	0
0,54	2,21	2,60	2,45	10,12	11,90	95	A++	8,32	7,00	295	A+	4,02	5,50	1912	4,39	1,11	A+++	5,77	3,60	872	3,60	0
0,58	2,39	2,66	2,67	10,94	12,17	95	A++	8,23	7,70	328	A+	4,03	5,50	1906	4,39	1,11	A+++	5,76	3,70	899	3,70	0
0,58	2,77	2,66	2,67	12,68	12,17	95	A++	8,14	8,00	344	A+	4,13	6,46	2189	4,93	1,53	A+++	5,75	3,80	925	3,80	0
0,60	2,71	2,80	2,75	12,41	12,81	95	A++	8,14	8,00	344	A+	4,16	6,46	2173	4,95	1,51	A+++	5,71	3,90	957	3,90	0
0,64	2,69	2,79	2,93	12,32	12,77	95	A++	8,03	9,00	392	A+	4,19	6,46	2157	4,97	1,49	A+++	5,66	4,00	988	4,00	0
0,52	2,00	2,46	2,37	9,16	11,26	95	A++	8,30	6,50	275	A+	4,05	4,80	1657	3,99	0,81	A+++	5,78	3,60	872	3,60	0
0,56	2,35	2,66	2,58	10,76	12,17	95	A++	8,28	7,50	317	A+	4,05	5,50	1901	4,39	1,11	A+++	5,80	3,70	892	3,70	0
0,60	2,74	2,66	2,75	12,55	12,17	95	A++	8,11	8,00	345	A+	4,06	5,50	1895	4,39	1,11	A+++	5,79	3,70	894	3,70	0
0,61	2,63	2,82	2,80	12,04	12,91	95	A++	8,14	8,00	344	A+	4,15	6,46	2176	4,94	1,52	A+++	5,78	3,80	920	3,80	0
0,62	2,58																					

Combinatietabellen

Binnenuit	Koelcapaciteit [kW]					Totale koelcapaciteit [kW]			Opgenomen vermogen koelen [kW]			Totale stroom koelen [A]			Verwarmingscapaciteit [kW]					Totale verwarmingscapaciteit [kW]		
	Kamer A	Kamer B	Kamer C	Kamer D	Kamer E	Min.	Nom.	Max.	Min.	Nom.	Max.	Min.	Nom.	Max.	Kamer A	Kamer B	Kamer C	Kamer D	Kamer E	Min.	Nom.	Max.
	1,5+4,2+4,2	1,36	3,82	3,82	---	---	2,83	9,00	8,69	0,55	2,73	2,51	2,53	12,50	11,50	1,52	4,24	4,24	---	---	3,46	10,00
1,5+4,2+5,0	1,26	3,53	4,21	---	---	2,95	9,00	8,88	0,56	2,62	2,52	2,57	12,00	11,60	1,40	3,93	4,67	---	---	3,69	10,00	11,03
1,5+4,2+6,0	1,15	3,23	4,62	---	---	3,10	9,00	9,51	0,59	2,58	2,90	2,69	11,90	13,30	1,28	3,59	5,13	---	---	3,98	10,00	11,27
1,5+4,2+7,1	1,05	2,95	4,99	---	---	3,32	9,00	9,53	0,57	2,58	2,90	2,70	11,80	13,27	1,17	3,28	5,55	---	---	4,29	10,00	11,30
1,5+5,0+5,0	1,17	3,91	3,91	---	---	3,07	9,00	9,27	0,59	2,52	2,66	2,69	11,60	12,20	1,30	4,35	4,35	---	---	3,92	10,00	11,17
1,5+5,0+6,0	1,08	3,60	4,32	---	---	3,35	9,00	9,70	0,56	2,51	2,91	2,70	11,50	13,40	1,20	4,00	4,80	---	---	4,21	10,00	11,41
1,5+5,0+7,1	0,99	3,31	4,70	---	---	3,53	9,00	9,72	0,60	2,51	2,92	2,80	11,50	13,40	1,10	3,68	5,22	---	---	4,53	10,00	11,44
1,5+6,0+6,0	1,00	4,00	4,00	---	---	3,53	9,00	10,20	0,60	2,47	3,25	2,80	11,40	15,00	1,11	4,44	4,44	---	---	4,50	10,00	11,65
1,5+6,0+7,1	0,92	3,70	4,38	---	---	3,53	9,00	10,22	0,60	2,47	3,25	2,80	11,40	15,00	1,32	3,97	4,70	---	---	4,81	10,00	11,68
2,0+2,0+2,0	2,00	2,00	2,00	---	---	2,31	6,00	6,80	0,46	1,33	1,63	2,11	6,10	7,50	2,50	2,50	2,50	---	---	2,33	7,50	10,49
2,0+2,0+2,5	2,00	2,00	2,50	---	---	2,36	6,50	7,17	0,46	1,52	1,78	2,11	7,00	8,20	2,46	2,46	3,08	---	---	2,48	8,00	10,57
2,0+2,0+3,5	2,00	2,00	3,50	---	---	2,48	7,50	7,88	0,50	1,93	2,10	2,27	8,90	9,70	2,40	2,40	4,20	---	---	2,77	9,00	10,68
2,0+2,0+4,2	2,00	2,00	4,20	---	---	2,58	8,20	8,31	0,50	2,27	2,33	2,27	10,40	10,70	2,29	2,29	4,81	---	---	2,97	9,40	10,68
2,0+2,0+5,0	1,78	1,78	4,44	---	---	2,70	8,00	8,71	0,52	2,09	2,46	2,40	9,60	11,30	2,22	2,22	5,56	---	---	3,20	10,00	10,90
2,0+2,0+6,0	1,70	1,70	5,10	---	---	2,85	8,50	9,24	0,53	2,33	2,76	2,44	10,70	12,70	2,00	2,00	6,00	---	---	3,49	10,00	11,14
2,0+2,0+7,1	1,62	1,62	5,76	---	---	3,01	9,00	9,54	0,56	2,62	2,96	2,57	12,00	13,60	1,80	1,80	6,40	---	---	3,80	10,00	11,18
2,0+2,5+2,5	2,00	2,50	2,50	---	---	2,42	7,00	7,52	0,46	1,71	1,94	2,11	7,90	8,90	2,43	3,04	3,04	---	---	2,62	8,50	10,59
2,0+2,5+3,5	1,88	2,34	3,28	---	---	2,55	7,50	8,22	0,50	1,92	2,27	2,27	8,80	10,40	2,33	2,91	4,07	---	---	2,92	9,30	10,68
2,0+2,5+4,2	1,84	2,30	3,86	---	---	2,66	8,00	8,53	0,52	2,15	2,44	2,40	9,90	11,30	2,30	2,87	4,83	---	---	3,12	10,00	10,77
2,0+2,5+5,0	1,68	2,11	4,21	---	---	2,77	8,00	8,83	0,52	2,09	2,52	2,40	9,60	11,60	2,11	2,63	5,26	---	---	3,35	10,00	11,11
2,0+2,5+6,0	1,66	2,07	4,97	---	---	2,92	8,70	9,36	0,56	2,44	2,83	2,57	11,20	13,00	1,90	2,38	5,71	---	---	3,63	10,00	11,14
2,0+2,5+7,1	1,55	1,94	5,51	---	---	3,08	9,00	9,56	0,59	2,62	2,96	2,69	12,00	13,60	1,72	2,16	6,12	---	---	3,95	10,00	11,18
2,0+3,5+3,5	1,78	3,11	3,11	---	---	2,70	8,00	8,67	0,52	2,15	2,51	2,40	9,90	11,50	2,22	3,89	3,89	---	---	3,20	10,00	10,77
2,0+3,5+4,2	1,75	3,07	3,68	---	---	2,80	8,50	8,68	0,55	2,42	2,51	2,53	11,10	11,50	2,06	3,61	4,33	---	---	3,41	10,00	10,97
2,0+3,5+5,0	1,66	2,90	4,14	---	---	2,92	8,70	8,87	0,56	2,44	2,52	2,57	11,20	11,60	1,90	3,33	4,76	---	---	3,63	10,00	11,34
2,0+3,5+6,0	1,57	2,74	4,70	---	---	3,07	9,00	9,50	0,59	2,58	2,90	2,69	11,90	13,30	1,74	3,04	5,22	---	---	3,92	10,00	11,34
2,0+3,5+7,1	1,43	2,50	5,07	---	---	3,32	9,00	9,51	0,57	2,58	2,90	2,70	11,80	13,30	1,59	2,78	5,63	---	---	4,23	10,00	11,35
2,0+4,2+4,2	1,67	3,51	3,51	---	---	2,91	8,70	8,69	0,55	2,54	2,51	2,53	11,70	11,50	1,92	4,04	4,04	---	---	3,60	10,00	10,98
2,0+4,2+5,0	1,61	3,38	4,02	---	---	3,02	9,00	9,09	0,59	2,62	2,64	2,69	12,00	12,20	1,79	3,75	4,46	---	---	3,84	10,00	11,35
2,0+4,2+6,0	1,48	3,10	4,43	---	---	3,32	9,00	9,51	0,57	2,58	2,90	2,70	11,90	13,30	1,64	3,44	4,92	---	---	4,12	10,00	11,37
2,0+4,2+7,1	1,35	2,84	4,80	---	---	3,49	9,00	9,53	0,60	2,58	2,90	2,80	11,80	13,30	1,50	3,16	5,34	---	---	4,44	10,00	11,40
2,0+5,0+5,0	1,50	3,75	3,75	---	---	3,14	9,00	9,27	0,59	2,52	2,66	2,69	11,60	12,20	1,67	4,17	4,17	---	---	4,07	10,00	11,06
2,0+5,0+6,0	1,38	3,46	4,15	---	---	3,35	9,00	9,70	0,56	2,51	2,91	2,70	11,50	13,40	1,54	3,85	4,62	---	---	4,36	10,00	11,29
2,0+5,0+7,1	1,28	3,19	4,53	---	---	3,53	9,00	9,72	0,60	2,51	2,92	2,80	11,50	13,40	1,42	3,55	5,04	---	---	4,67	10,00	11,33
2,0+6,0+6,0	1,29	3,86	3,86	---	---	3,53	9,00	10,20	0,60	2,47	3,25	2,80	11,40	15,00	1,43	4,29	4,29	---	---	4,64	10,00	11,53
2,0+6,0+7,1	1,19	3,58	4,23	---	---	3,70	9,00	10,65	0,64	2,47	3,60	3,00	11,40	16,60	1,32	3,97	4,70	---	---	4,96	10,00	11,56
2,5+2,5+2,5	2,50	2,50	2,50	---	---	2,48	7,50	7,87	0,50	1,93	2,10	2,27	8,90	9,70	3,33	3,33	3,33	---	---	2,77	10,00	10,72
2,5+2,5+3,5	2,35	2,35	3,29	---	---	2,63	8,00	8,44	0,52	2,15	2,39	2,40	9,90	11,00	2,94	2,94	4,12	---	---	3,06	10,00	10,92
2,5+2,5+4,2	2,17	2,17	3,65	---	---	2,73	8,00	8,65	0,52	2,15	2,50	2,40	9,90	11,50	2,72	2,72	4,57	---	---	3,26	10,00	11,04
2,5+2,5+5,0	2,13	2,13	4,25	---	---	2,85	8,50	8,84	0,56	2,33	2,52	2,57	10,70	11,60	2,50	2,50	5,00	---	---	3,49	10,00	11,33
2,5+2,5+6,0	2,05	2,05	4,91	---	---	2,99	9,00	9,37	0,56	2,62	2,83	2,57	12,00	13,00	2,27	2,27	5,45	---	---	3,77	10,00	11,35
2,5+2,5+7,1	1,86	1,86	5,28	---	---	3,32	9,00	9,58	0,57	2,62	2,96	2,70	12,00	13,60	2,07	2,07	5,87	---	---	4,09	10,00	11,37
2,5+3,5+3,5	2,11	2,95	2,95	---	---	2,77	8,00	8,68	0,55	2,14	2,51	2,53	9,90	11,50	2,63	3,68	3,68	---	---	3,35	10,00	11,19
2,5+3,5+4,2	2,08	2,92	3,50	---	---	2,88	8,50	8,69	0,55	2,42	2,51	2,53	11,10	11,50	2,45	3,43	4,12	---	---	3,55	10,00	11,20
2,5+3,5+5,0	2,05	2,86	4,09	---	---	2,99	9,00	8,89	0,59	2,62	2,52	2,69	12,00	11,60	2,27	3,18	4,55	---	---	3,77	10,00	11,34
2,5+3,5+6,0	1,88	2,63	4,50	---	---	3,14	9,00	9,51	0,59	2,58	2,90	2,69	11,80	13,30	2,08	2,92	5,00	---	---	4,07	10,00	11,35
2,5+3,5+7,1	1,72	2,40	4,88	---	---	3,33	9,00	9,53	0,57	2,57	2,90	2,70	11,80	13,30	1,91	2,67	5,42	---	---	4,39	10,00	11,40
2,5+4,2+4,2	2,06	3,47	3,47	---	---	2,98	9,00	8,71	0,59	2,72	2,51	2,69	12,50	11,50	2,29	3,85	3,85	---	---	3,75	10,00	11,20
2,5+4,2+5,0	1,92	3,23	3,85	---	---	3,10	9,00	9,10	0,59	2,58	2,64	2,69	11,90	12,20	2,14	3,59	4,27	---	---	3,98	10,00	11,35
2,5+4,2+6,0	1,77	2,98	4,25	---	---	3,32	9,00	9,52	0,57	2,58	2,90	2,70	11,80	13,30	1,97	3,31	4,72	---	---	4,26	10,00	11,37
2,5+4,2+7,1	1,63	2,74	4,63	---	---	3,50	9,00	9,54	0,60	2,57	2,90	2,80	11,80	13,40	1,81	3,04	5,14	---	---	4,58	10,00	11,40
2,5+5,0+5,0	1,80	3,60	3,60	---	---	3,35	9,00	9,28	0,56	2,51	2,66	2,70	11,60	12,20	2,00	4,00	4,00	---	---	4,21	10,00	11,06
2,5+5,0+6,0	1,67	3,33	4,00	---	---	3,53	9,00	9,72	0,60	2,51	2,92	2,80	11,50	13,40	1,85	3,70	4,44	---	---	4,50	10,00	11,29
2,5+5,0+7,1	1,54	3,08	4,38	---	---	3,53	9,00	9,73	0,60	2,48	2,92	2,80	11,40	13,40	1,71	3,42	4,86	---	---	4,81	10,00	11,33
2,5+6,0+6,0	1,55	3,72	3,72	---	---	3,53	9,00	10,22	0,60	2,47	3,25	2,80	11,40	15,00	1,72	4,14	4,14	---	---	4,78	10,00	11,53
2,5+6,0+7,1	1,44	3,46	4,10	---	---	3,71	9,00	10,66	0,64	2,47	3,60	3,00	11,40	16,60	1,60	3,85	4,55	---	---	5,10	10,00	11,56
3,5+3,5+3,5	2,90	2,90	2,90	---	---	2,92	8,70	8,83	0,59	2,50	2,57	2,69	11,50	11,80	3,33	3,33	3,33	---	---	3,63	10,00	11,19
3,5+3,5+4,2	2,81	2,81	3,38	---	---	3,02	9,00	8,84	0,59	2,68	2,57	2,69	12,30	11,90	3,13	3,13	3,75	---	---</			

Opgenomen vermogen verwarmen [kW]			Totale stroom verwarmen [A]			Vermogens-factor (%)	Seizoensgegevens koelen				Seizoensgegevens verwarmen (gemiddeld klimaat)						Seizoensgegevens verwarmen (warm klimaat)					
Min.	Nom.	Max.	Min.	Nom.	Max.		label	SEER	Ontwerp-capaciteit	AEC	label	SCOP	Ontwerp-capaciteit	AEC	Opgegeven capaciteit bij -10°C	Capaciteit back-upverwarming bij -10°C	label	SCOP	Ontwerp-capaciteit	AEC	Opgegeven capaciteit bij +2°C	Capaciteit back-upverwarming bij +2°C
0,68	2,69	2,92	3,10	12,32	13,36	95	A++	8,26	9,90	419	A+	4,12	6,46	2194	4,93	1,53	A+++	5,86	3,80	907	3,80	0
0,71	2,59	2,82	3,23	11,86	12,91	95	A++	8,18	9,00	385	A+	4,18	6,46	2162	4,94	1,52	A+++	5,78	3,90	944	3,90	0
0,71	2,54	2,80	3,27	11,63	12,81	95	A++	8,19	9,00	385	A+	4,21	6,46	2147	4,96	1,50	A+++	5,74	4,00	975	4,00	0
0,76	2,49	2,78	3,48	11,40	12,72	95	A++	8,20	9,00	384	A+	4,24	6,46	2132	4,98	1,48	A+++	5,70	4,10	1007	4,10	0
0,71	2,50	2,83	3,23	11,45	12,95	95	A++	8,21	9,00	384	A+	4,19	6,46	2156	4,95	1,51	A+++	5,78	3,90	944	3,90	0
0,71	2,46	2,75	3,27	11,26	12,59	95	A++	8,22	9,00	384	A+	4,22	6,46	2140	4,97	1,49	A+++	5,74	4,00	975	4,00	0
0,79	2,41	2,73	3,61	11,03	12,49	95	A++	8,22	9,00	383	A+	4,25	6,46	2125	4,99	1,47	A+++	5,70	4,10	1006	4,10	0
0,72	2,42	2,67	3,31	11,08	12,22	95	A++	8,22	9,00	383	A+	4,24	6,46	2133	4,97	1,49	A+++	5,75	4,00	974	4,00	0
0,79	2,40	2,66	3,61	10,99	12,17	95	A++	8,23	9,00	383	A+	4,26	6,46	2119	4,99	1,47	A+++	5,70	4,10	1006	4,10	0
0,50	1,77	2,50	2,28	8,11	11,44	95	A++	8,30	6,00	253	A+	4,03	4,80	1665	4,00	0,80	A+++	5,75	3,60	877	3,60	0
0,52	1,92	2,54	2,37	8,79	11,62	95	A++	8,30	6,50	275	A+	4,04	4,80	1660	4,00	0,80	A+++	5,74	3,60	878	3,60	0
0,56	2,27	2,66	2,58	10,39	12,17	95	A++	8,28	7,50	317	A+	4,06	5,60	1931	4,46	1,14	A+++	5,77	3,70	897	3,70	0
0,60	2,47	2,66	2,75	11,31	12,17	95	A++	8,13	8,20	353	A+	4,07	5,60	1925	4,46	1,14	A+++	5,76	3,70	899	3,70	0
0,61	2,76	2,82	2,80	12,64	12,91	95	A++	8,14	8,00	344	A+	4,16	6,46	2174	4,95	1,51	A+++	5,74	3,80	927	3,80	0
0,62	2,72	2,80	2,84	12,45	12,81	95	A++	8,08	8,50	368	A+	4,19	6,46	2158	4,97	1,49	A+++	5,70	3,90	958	3,90	0
0,66	2,67	2,79	3,01	12,22	12,77	95	A++	8,04	9,00	392	A+	4,22	6,46	2142	4,99	1,47	A+++	5,65	4,00	990	4,00	0
0,54	2,15	2,63	2,45	9,84	12,04	95	A++	8,32	7,00	295	A+	4,07	5,00	1716	4,11	0,89	A+++	5,78	3,60	871	3,60	0
0,58	2,45	2,66	2,67	11,22	12,17	95	A++	8,28	7,50	317	A+	4,09	5,60	1913	4,46	1,14	A+++	5,80	3,70	893	3,70	0
0,63	2,77	2,87	2,88	12,68	13,14	95	A++	8,11	8,00	345	A+	4,11	5,60	1908	4,46	1,14	A+++	5,79	3,70	894	3,70	0
0,63	2,73	2,82	2,88	12,50	12,91	95	A++	8,14	8,00	344	A+	4,19	6,46	2154	4,95	1,51	A+++	5,77	3,90	947	3,90	0
0,64	2,68	2,80	2,93	12,27	12,81	95	A++	8,05	8,70	378	A+	4,22	6,46	2139	4,97	1,49	A+++	5,72	4,00	978	4,00	0
0,69	2,66	2,79	3,14	12,18	12,77	95	A++	8,05	9,00	392	A+	4,25	6,46	2124	4,99	1,47	A+++	5,68	4,00	985	4,00	0
0,65	2,76	2,87	2,97	12,64	13,14	95	A++	8,12	8,00	345	A+	4,25	6,46	2126	4,94	1,52	A+++	5,98	3,90	913	3,90	0
0,68	2,75	2,97	3,10	12,59	13,59	95	A++	8,07	8,50	369	A+	4,26	6,46	2120	4,94	1,52	A+++	5,97	3,90	915	3,90	0
0,68	2,73	3,04	3,10	12,50	13,91	95	A++	8,04	8,70	379	A+	4,32	6,46	2090	4,96	1,50	A+++	5,88	4,10	976	4,10	0
0,69	2,68	2,80	3,14	12,27	12,81	95	A++	8,05	9,00	392	A+	4,35	6,46	2076	4,97	1,49	A+++	5,84	4,20	1007	4,20	0
0,76	2,72	2,79	3,48	12,45	12,77	95	A++	8,06	9,00	391	A+	4,38	6,46	2062	4,99	1,47	A+++	5,79	4,20	1014	4,20	0
0,70	2,73	2,97	3,18	12,50	13,59	95	A++	8,06	8,70	378	A+	4,28	6,46	2113	4,95	1,51	A+++	5,97	4,00	938	4,00	0
0,72	2,71	3,04	3,31	12,41	13,91	95	A++	8,03	9,00	392	A+	4,34	6,46	2084	4,96	1,50	A+++	5,88	4,10	976	4,10	0
0,73	2,60	2,80	3,36	11,90	12,81	95	A++	8,05	9,00	392	A+	4,37	6,46	2069	4,98	1,48	A+++	5,84	4,20	1007	4,20	0
0,78	2,55	2,78	3,57	11,68	12,72	95	A++	8,06	9,00	391	A+	4,40	6,46	2055	5,00	1,46	A+++	5,80	4,30	1038	4,30	0
0,75	2,59	2,83	3,44	11,86	12,95	95	A++	8,09	9,00	390	A+	4,35	6,46	2077	4,96	1,50	A+++	5,88	4,10	975	4,10	0
0,74	2,55	2,75	3,40	11,68	12,59	95	A++	8,10	9,00	389	A+	4,38	6,46	2063	4,98	1,48	A+++	5,84	4,20	1006	4,20	0
0,81	2,53	2,73	3,70	11,58	12,49	95	A++	8,11	9,00	388	A+	4,41	6,46	2049	5,00	1,46	A+++	5,80	4,30	1038	4,30	0
0,77	2,44	2,67	3,53	11,17	12,22	95	A++	8,11	9,00	389	A+	4,39	6,46	2057	4,99	1,47	A+++	5,85	4,20	1006	4,20	0
0,82	2,39	2,66	3,74	10,94	12,17	95	A++	8,12	9,00	388	A+	4,42	6,46	2043	5,00	1,46	A+++	5,80	4,30	1037	4,30	0
0,56	2,67	2,66	2,58	12,22	12,17	95	A++	8,28	7,50	317	A+	4,09	5,00	1709	4,13	0,87	A+++	5,77	3,70	898	3,70	0
0,63	2,63	2,74	2,88	12,04	12,54	95	A++	8,13	8,00	345	A+	4,11	5,60	1906	4,48	1,12	A+++	5,79	3,70	894	3,70	0
0,65	2,61	2,87	2,97	11,95	13,14	95	A++	8,14	8,00	344	A+	4,12	5,60	1900	4,48	1,12	A+++	5,78	3,80	921	3,80	0
0,66	2,51	3,04	3,01	11,49	13,91	95	A++	8,07	8,50	369	A+	4,20	6,46	2152	4,97	1,49	A+++	5,75	3,90	949	3,90	0
0,67	2,46	2,80	3,05	11,26	12,81	95	A++	8,05	9,00	391	A+	4,23	6,46	2136	4,99	1,47	A+++	5,71	4,00	980	4,00	0
0,73	2,41	2,79	3,36	11,03	12,77	95	A++	8,07	9,00	391	A+	4,26	6,46	2121	5,00	1,46	A+++	5,67	4,10	1012	4,10	0
0,68	2,57	3,08	3,10	11,77	14,10	95	A++	8,14	8,00	344	A+	4,15	6,46	2176	4,96	1,50	A+++	5,85	3,80	909	3,80	0
0,70	2,55	3,08	3,18	11,68	14,10	95	A++	8,09	8,50	368	A+	4,16	6,46	2170	4,96	1,50	A+++	5,84	3,80	910	3,80	0
0,71	2,45	3,04	3,23	11,22	13,91	95	A++	8,05	9,00	392	A+	4,22	6,46	2139	4,97	1,49	A+++	5,76	3,90	948	3,90	0
0,71	2,40	2,80	3,27	10,99	12,81	95	A++	8,06	9,00	391	A+	4,25	6,46	2124	4,99	1,47	A+++	5,72	4,00	979	4,00	0
0,78	2,36	2,79	3,57	10,81	12,77	95	A++	8,07	9,00	390	A+	4,28	6,46	2110	5,01	1,45	A+++	5,67	4,10	1011	4,10	0
0,72	2,53	3,08	3,31	11,58	14,10	95	A++	8,01	9,00	394	A+	4,18	6,46	2163	4,96	1,50	A+++	5,85	3,80	910	3,80	0
0,75	2,43	3,04	3,44	11,13	13,91	95	A++	7,99	9,00	394	A+	4,24	6,46	2133	4,97	1,49	A+++	5,76	4,00	972	4,00	0
0,76	2,39	2,80	3,48	10,94	12,81	95	A++	8,01	9,00	394	A+	4,27	6,46	2118	4,99	1,47	A+++	5,72	4,00	979	4,00	0
0,81	2,34	2,78	3,70	10,71	12,72	95	A++	8,02	9,00	393	A+	4,30	6,46	2103	5,01	1,45	A+++	5,68	4,10	1011	4,10	0
0,78	2,41	2,83	3,57	11,03	12,95	95	A++	8,10	9,00	389	A+	4,25	6,46	2126	4,98	1,48	A+++	5,76	4,00	972	4,00	0
0,79	2,37	2,75	3,61	10,85	12,59	95	A++	8,11	9,00	388	A+	4,28	6,46	2111	5,00	1,46	A+++	5,72	4,10	1003	4,10	0
0,84	2,33	2,73	3,83	10,67	12,49	95	A++	8,12	9,00	388	A+	4,31	6,46	2097	5,02	1,44	A+++	5,68	4,10	1010	4,10	0
0,80	2,35	2,67	3,66	10,76	12,22	95	A++	8,12	9,00	388	A+	4,29	6,46	2105	5,00	1,46	A+++	5,72	4,10	1003	4,10	0
0,85	2,31	2,66	3,87	10,58	12,17	95	A++	8,13	9,00	388	A+	4,32	6,46	2091	5,02	1,44	A+++	5,68	4,20	1035	4,20	0
0,72	2,66	3,08	3,31	12,18	14,10	95	A++	8,05	8,70	378	A+	4,28	6,46	2111	4,98	1,48	A+++	5,94	4,00	943	4,00	0
0,75	2,63	3,08	3,44	12,04	14,10	95	A++	7,98	9,00	395	A+	4,29	6,46	2105	4,99	1,47	A+++	5,93	4,00	945	4,00	0
0,78	2,53	3,04	3,57	11,58	13,91	95	A++	7,97	9,00	395	A+	4,35	6,46	2076	5,00	1,46	A+++	5,84	4,10	983	4,10	0
0,79	2,48	2,80	3,61	11,36	12,81	95	A++	7,99	9,00	395	A+	4,38	6,46	2062	5,02	1,44	A+++	5,79	4,20	1014	4,20	0
0,84	2,43	2,78	3,83	11,13	12,72	95	A++	8,00	9,00	394	A+	4,41	6,46	2048	5,03	1,43	A+++	5,75	4,30			

Combinatietabellen

Binnennunit	Koelcapaciteit [kW]					Totale koelcapaciteit [kW]			Opgenomen vermogen koelen [kW]			Totale stroom koelen [A]			Verwarmingcapaciteit [kW]					Totale verwarmingcapaciteit [kW]		
	Kamer A	Kamer B	Kamer C	Kamer D	Kamer E	Min.	Nom.	Max.	Min.	Nom.	Max.	Min.	Nom.	Max.	Kamer A	Kamer B	Kamer C	Kamer D	Kamer E	Min.	Nom.	Max.
4,2+4,2+5,0	2,82	2,82	3,36	---	---	3,50	9,00	9,35	0,60	2,57	2,77	2,80	11,80	12,80	3,13	3,13	3,73	---	---	4,47	10,00	11,25
4,2+4,2+6,0	2,63	2,63	3,75	---	---	3,50	9,00	9,58	0,60	2,56	2,90	2,80	11,80	13,40	2,92	2,92	4,17	---	---	4,75	10,00	11,27
4,2+4,2+7,1	2,44	2,44	4,12	---	---	3,67	9,00	10,06	0,64	2,56	3,24	3,00	11,80	14,90	2,71	2,71	4,58	---	---	5,07	10,00	11,30
4,2+5,0+5,0	2,66	3,17	3,17	---	---	3,53	9,00	9,23	0,60	2,47	2,60	2,80	11,40	11,90	2,96	3,52	3,52	---	---	4,70	10,00	11,07
4,2+5,0+6,0	2,49	2,96	3,55	---	---	3,71	9,00	10,24	0,64	2,47	3,25	3,00	11,30	15,00	2,76	3,29	3,95	---	---	4,99	10,00	11,30
5,0+5,0+5,0	3,00	3,00	3,00	---	---	3,73	9,00	10,00	0,64	2,41	3,00	3,00	11,10	13,80	3,33	3,33	3,33	---	---	4,93	10,00	11,20
1,5+1,5+1,5+1,5	1,65	1,65	1,65	1,65	---	2,31	6,60	7,10	0,44	1,35	1,55	2,02	6,20	7,10	1,83	1,83	1,83	1,83	---	2,33	7,30	10,12
1,5+1,5+1,5+2,0	1,55	1,55	1,55	2,06	---	2,36	6,70	7,30	0,47	1,43	1,66	2,15	6,53	7,58	1,85	1,85	1,85	2,46	---	2,48	8,00	10,30
1,5+1,5+1,5+2,5	1,50	1,50	1,50	2,50	---	2,42	7,00	7,50	0,47	1,53	1,74	2,15	7,00	7,98	1,82	1,82	1,82	3,04	---	2,63	8,50	10,41
1,5+1,5+1,5+3,5	1,41	1,41	1,41	3,28	---	2,55	7,50	8,18	0,50	1,74	2,02	2,27	8,00	9,30	1,74	1,74	1,74	4,07	---	2,92	9,30	10,60
1,5+1,5+1,5+4,2	1,38	1,38	1,38	3,86	---	2,66	8,00	8,55	0,50	1,95	2,19	2,27	9,00	10,10	1,72	1,72	1,72	4,83	---	3,12	10,00	11,17
1,5+1,5+1,5+5,0	1,26	1,26	1,26	4,21	---	2,77	8,00	9,03	0,53	1,90	2,37	2,44	8,80	10,90	1,58	1,58	1,58	5,26	---	3,35	10,00	11,29
1,5+1,5+1,5+6,0	1,24	1,24	1,24	4,97	---	2,92	8,70	9,50	0,53	2,23	2,62	2,44	10,20	12,10	1,43	1,43	1,43	5,71	---	3,63	10,00	11,53
1,5+1,5+1,5+7,1	1,16	1,16	1,16	5,51	---	3,08	9,00	9,95	0,56	2,36	2,88	2,57	10,90	13,20	1,29	1,29	1,29	6,12	---	3,95	10,00	11,56
1,5+1,5+2,0+2,0	1,50	1,50	2,00	2,00	---	2,42	7,00	7,50	0,47	1,53	1,74	2,15	7,00	8,10	1,82	1,82	2,43	2,43	---	2,63	8,50	10,49
1,5+1,5+2,0+2,5	1,50	1,50	2,00	2,50	---	2,48	7,50	7,90	0,47	1,74	1,91	2,15	8,00	8,80	1,80	1,80	2,40	3,00	---	2,77	9,00	10,59
1,5+1,5+2,0+3,5	1,41	1,41	1,88	3,29	---	2,63	8,00	8,42	0,50	1,95	2,13	2,27	9,00	9,80	1,76	1,76	2,35	4,12	---	3,06	10,00	10,69
1,5+1,5+2,0+4,2	1,30	1,30	1,74	3,65	---	2,73	8,00	8,90	0,53	1,95	2,36	2,44	9,00	10,90	1,63	1,63	2,17	4,57	---	3,26	10,00	11,17
1,5+1,5+2,0+5,0	1,28	1,28	1,70	4,25	---	2,85	8,50	9,26	0,53	2,13	2,50	2,44	9,80	11,50	1,50	1,50	2,00	5,00	---	3,49	10,00	11,29
1,5+1,5+2,0+6,0	1,23	1,23	1,64	4,91	---	2,99	9,00	9,72	0,56	2,36	2,75	2,57	10,90	12,60	1,36	1,36	1,82	5,45	---	3,77	10,00	11,53
1,5+1,5+2,0+7,1	1,12	1,12	1,49	5,28	---	3,16	9,00	10,05	0,60	2,36	2,95	2,74	10,90	13,60	1,24	1,24	1,65	5,87	---	4,09	10,00	11,56
1,5+1,5+2,5+2,5	1,41	1,41	2,34	2,34	---	2,55	7,50	8,16	0,50	1,74	2,02	2,27	8,00	9,30	1,88	1,88	3,13	3,13	---	2,92	10,00	10,59
1,5+1,5+2,5+3,5	1,33	1,33	2,22	3,11	---	2,70	8,00	8,79	0,53	1,95	2,31	2,44	9,00	10,60	1,67	1,67	2,78	3,89	---	3,20	10,00	11,16
1,5+1,5+2,5+4,2	1,31	1,31	2,19	3,68	---	2,80	8,50	9,14	0,53	2,17	2,49	2,44	10,00	11,40	1,55	1,55	2,58	4,33	---	3,41	10,00	11,17
1,5+1,5+2,5+5,0	1,24	1,24	2,07	4,14	---	2,92	8,70	9,49	0,56	2,23	2,62	2,57	10,30	12,10	1,43	1,43	2,38	4,76	---	3,63	10,00	11,29
1,5+1,5+2,5+6,0	1,17	1,17	1,96	4,70	---	3,07	9,00	9,84	0,56	2,36	2,81	2,57	10,90	13,00	1,30	1,30	2,17	5,22	---	3,92	10,00	11,53
1,5+1,5+2,5+7,1	1,07	1,07	1,79	5,07	---	3,23	9,00	10,16	0,60	2,36	3,01	2,74	10,80	13,90	1,19	1,19	1,98	5,63	---	4,23	10,00	11,56
1,5+1,5+3,5+3,5	1,28	1,28	2,98	2,98	---	2,85	8,50	9,27	0,53	2,17	2,55	2,44	10,00	11,70	1,50	1,50	3,50	3,50	---	3,49	10,00	11,17
1,5+1,5+3,5+4,2	1,26	1,26	2,94	3,53	---	2,95	9,00	9,39	0,56	2,41	2,61	2,57	11,10	12,00	1,40	1,40	3,27	3,93	---	3,69	10,00	11,17
1,5+1,5+3,5+5,0	1,17	1,17	2,74	3,91	---	3,07	9,00	9,74	0,59	2,36	2,75	2,69	10,80	12,70	1,30	1,30	3,04	4,35	---	3,92	10,00	11,30
1,5+1,5+3,5+6,0	1,08	1,08	2,52	4,32	---	3,21	9,00	10,18	0,59	2,36	3,02	2,69	10,80	13,90	1,20	1,20	2,80	4,80	---	4,21	10,00	11,54
1,5+1,5+3,5+7,1	0,99	0,99	2,32	4,70	---	3,42	9,00	10,20	0,56	2,35	3,02	2,70	10,80	13,90	1,10	1,10	2,57	5,22	---	4,53	10,00	11,58
1,5+1,5+4,2+4,2	1,18	1,18	3,32	3,32	---	3,05	9,00	9,61	0,59	2,41	2,74	2,69	11,10	12,60	1,32	1,32	3,68	3,68	---	3,90	10,00	11,18
1,5+1,5+4,2+5,0	1,11	1,11	3,10	3,69	---	3,17	9,00	9,75	0,59	2,36	2,75	2,69	10,80	12,70	1,23	1,23	3,44	4,10	---	4,12	10,00	11,32
1,5+1,5+4,2+6,0	1,02	1,02	2,86	4,09	---	3,41	9,00	10,19	0,56	2,35	3,02	2,70	10,80	13,90	1,14	1,14	3,18	4,55	---	4,41	10,00	11,55
1,5+1,5+4,2+7,1	0,94	0,94	2,64	4,47	---	3,60	9,00	10,20	0,60	2,35	3,02	2,80	10,80	13,90	1,05	1,05	2,94	4,97	---	4,72	10,00	11,59
1,5+1,5+5,0+5,0	1,04	1,04	3,46	3,46	---	3,43	9,00	9,97	0,56	2,31	2,83	2,70	10,60	13,00	1,15	1,15	3,85	3,85	---	4,36	10,00	11,45
1,5+1,5+5,0+6,0	0,96	0,96	3,21	3,86	---	3,44	9,00	10,42	0,56	2,31	3,10	2,70	10,60	14,20	1,07	1,07	3,57	4,29	---	4,64	10,00	11,68
1,5+1,5+5,0+7,1	0,89	0,89	2,98	4,23	---	3,62	9,00	10,73	0,60	2,30	3,30	2,80	10,60	15,20	0,99	0,99	3,31	4,70	---	4,96	10,00	11,72
1,5+1,5+6,0+6,0	0,90	0,90	3,60	3,60	---	3,62	9,00	10,74	0,60	2,30	3,31	2,80	10,60	15,20	1,00	1,00	4,00	4,00	---	4,93	10,00	11,92
1,5+2,0+2,0+2,0	1,50	2,00	2,00	2,00	---	2,48	7,50	7,89	0,47	1,74	1,91	2,15	8,00	8,80	1,90	2,53	2,53	2,53	---	2,77	9,50	10,68
1,5+2,0+2,0+2,5	1,41	1,88	1,88	2,34	---	2,55	7,50	8,15	0,50	1,74	2,02	2,27	8,00	9,30	1,88	2,50	2,50	3,13	---	2,92	10,00	10,77
1,5+2,0+2,0+3,5	1,33	1,78	1,78	3,11	---	2,70	8,00	8,78	0,53	1,95	2,30	2,44	9,00	10,60	1,67	2,22	2,22	3,89	---	3,20	10,00	11,16
1,5+2,0+2,0+4,2	1,31	1,75	1,75	3,68	---	2,80	8,50	9,12	0,53	2,18	2,49	2,44	10,00	11,40	1,55	2,06	2,06	4,33	---	3,41	10,00	11,17
1,5+2,0+2,0+5,0	1,24	1,66	1,66	4,14	---	2,92	8,70	9,48	0,56	2,23	2,62	2,57	10,30	12,00	1,43	1,90	1,90	4,76	---	3,63	10,00	11,29
1,5+2,0+2,0+6,0	1,17	1,57	1,57	4,70	---	3,07	9,00	9,94	0,56	2,36	2,88	2,57	10,90	13,20	1,30	1,74	1,74	5,22	---	3,92	10,00	11,53
1,5+2,0+2,0+7,1	1,07	1,43	1,43	5,07	---	3,23	9,00	10,26	0,60	2,36	3,08	2,74	10,90	14,20	1,19	1,59	1,59	5,63	---	4,23	10,00	11,56
1,5+2,0+2,5+2,5	1,41	1,88	2,35	2,35	---	2,63	8,00	8,52	0,50	1,95	2,19	2,27	9,00	10,10	1,76	2,35	2,94	2,94	---	3,06	10,00	10,77
1,5+2,0+2,5+3,5	1,26	1,68	2,11	2,95	---	2,77	8,00	9,02	0,53	1,95	2,42	2,44	9,00	11,20	1,58	2,11	2,63	3,68	---	3,35	10,00	11,16
1,5+2,0+2,5+4,2	1,25	1,67	2,08	3,50	---	2,88	8,50	9,36	0,56	2,17	2,61	2,57	10,00	12,00	1,47	1,96	2,45	4,12	---	3,55	10,00	11,17
1,5+2,0+2,5+5,0	1,23	1,64	2,05	4,00	---	2,99	9,00	9,49	0,56	2,36	2,62	2,57	10,90	12,10	1,36	1,82	2,27	4,55	---	3,77	10,00	11,29
1,5+2,0+2,5+6,0	1,13	1,50	1,88	4,50	---	3,14	9,00	10,05	0,59	2,36	2,95	2,69	10,90	13,60	1,25	1,67	2,08	5,00	---	4,07	10,00	11,53
1,5+2,0+2,5+7,1	1,03	1,37	1,72	4,88	---	3,41	9,00	10,16	0,56	2,36	3,01	2,70	10,80	13,90	1,15	1,53	1,91	5,42	---	4,39	10,00	11,56
1,5+2,0+3,5+3,5	1,24	1,66	2,90	2,90	---	2,92	8,70	9,38	0,56	2,28	2,61	2,57	10,50	12,00	1,43	1,90	3,33	3,33	---	3,63	10,00	11,17
1,5+2,0+3,5+4,2	1,21	1,61	2,81	3,38	---	3,02	9,00	9,60	0,56	2,41	2,74	2,57	11,10	12,60	1,34	1,79	3,13	3,75	---	3,84	10,00	11,17

Opgenomen vermogen verwarmen [kW]			Totale stroom verwarmen [A]			Vermogensfactor [%]	Seizoensgegevens koelen				Seizoensgegevens verwarmen (gemiddeld klimaat)						Seizoensgegevens verwarmen (warm klimaat)					
Min.	Nom.	Max.	Min.	Nom.	Max.		label	SEER	Ontwerp-capaciteit	AEC	label	SCOP	Ontwerp-capaciteit	AEC	Opgegeven capaciteit bij -10°C	Capaciteit back-upverwarming bij -10°C	label	SCOP	Ontwerp-capaciteit	AEC	Opgegeven capaciteit bij +2°C	Capaciteit back-upverwarming bij +2°C
0,86	2,49	2,87	3,91	11,40	13,14	95	A++	7,99	9,00	395	A+	4,38	6,46	2063	5,00	1,46	A++++	5,84	4,20	1006	4,20	0
0,86	2,44	2,79	3,96	11,17	12,77	95	A++	8,00	9,00	394	A+	4,41	6,46	2049	5,02	1,44	A++++	5,80	4,30	1038	4,30	0
0,92	2,39	2,78	4,22	10,94	12,72	95	A++	8,01	9,00	394	A+	4,44	6,46	2036	5,04	1,42	A++++	5,76	4,30	1045	4,30	0
0,86	2,47	2,82	3,91	11,31	12,91	95	A++	7,99	9,00	394	A+	4,39	6,46	2057	5,01	1,45	A++++	5,85	4,20	1006	4,20	0
0,87	2,42	2,74	4,00	11,08	12,54	95	A++	8,00	9,00	394	A+	4,42	6,46	2043	5,03	1,43	A++++	5,80	4,30	1037	4,30	0
0,89	2,45	2,78	4,09	11,22	12,72	95	A++	8,00	9,00	394	A+	4,41	6,46	2051	5,01	1,45	A++++	5,85	4,30	1029	4,30	0
0,43	1,71	2,14	1,98	7,83	9,79	95	A++	8,33	6,00	252	A+	4,01	6,46	2252	4,97	1,49	A++++	5,78	3,40	824	3,40	0
0,45	1,93	2,24	2,06	8,84	10,25	95	A++	8,44	6,50	270	A+	4,03	6,46	2242	4,97	1,49	A++++	5,77	3,50	849	3,50	0
0,47	2,07	2,24	2,15	9,48	10,25	95	A+++	8,57	7,00	286	A+	4,05	6,46	2233	4,97	1,49	A++++	5,77	3,50	849	3,50	0
0,51	2,32	2,53	2,32	10,62	11,58	95	A+++	8,58	7,50	306	A+	4,08	6,46	2214	4,98	1,48	A++++	5,76	3,50	850	3,50	0
0,55	2,60	2,79	2,54	11,90	12,77	95	A++	8,38	8,00	335	A+	4,08	6,46	2216	4,99	1,47	A++++	5,76	3,60	875	3,60	0
0,55	2,50	2,74	2,54	11,45	12,54	95	A++	8,37	8,00	335	A+	4,15	6,46	2179	5,00	1,46	A++++	5,70	3,70	909	3,70	0
0,56	2,45	2,67	2,58	11,22	12,22	95	A++	8,15	8,70	374	A+	4,18	6,46	2161	5,00	1,46	A++++	5,67	3,80	939	3,80	0
0,62	2,40	2,65	2,84	10,99	12,13	95	A++	8,20	9,00	385	A+	4,21	6,46	2145	5,00	1,46	A++++	5,63	3,90	969	3,90	0
0,47	2,04	2,28	2,15	9,34	10,43	95	A+++	8,57	7,00	286	A+	4,13	6,46	2187	4,97	1,49	A++++	5,83	3,50	840	3,50	0
0,49	2,19	2,54	2,24	10,03	11,62	95	A+++	8,57	7,50	307	A+	4,15	6,46	2178	4,98	1,48	A++++	5,83	3,50	840	3,50	0
0,55	2,52	2,53	2,54	11,54	11,58	95	A++	8,38	8,00	335	A+	4,18	6,46	2160	4,99	1,47	A++++	5,82	3,50	841	3,50	0
0,57	2,50	2,79	2,62	11,45	12,77	95	A++	8,38	8,00	334	A+	4,18	6,46	2163	4,99	1,47	A++++	5,82	3,60	866	3,60	0
0,60	2,40	2,74	2,75	10,99	12,54	95	A++	8,20	8,50	363	A+	4,25	6,46	2128	5,00	1,46	A++++	5,76	3,70	899	3,70	0
0,58	2,35	2,67	2,67	10,76	12,22	95	A++	8,20	9,00	385	A+	4,28	6,46	2112	5,00	1,46	A++++	5,72	3,80	929	3,80	0
0,65	2,31	2,65	2,97	10,58	12,13	95	A++	8,21	9,00	384	A+	4,31	6,46	2096	5,01	1,45	A++++	5,69	3,90	959	3,90	0
0,54	2,54	2,54	2,45	11,63	11,62	95	A+++	8,57	7,50	307	A+	4,17	6,46	2168	4,98	1,48	A++++	5,84	3,50	838	3,50	0
0,57	2,50	2,80	2,62	11,45	12,81	95	A++	8,39	8,00	334	A+	4,18	6,46	2162	4,99	1,47	A++++	5,83	3,60	864	3,60	0
0,59	2,48	2,79	2,71	11,36	12,77	95	A++	8,18	8,50	364	A+	4,19	6,46	2154	4,99	1,47	A++++	5,83	3,60	864	3,60	0
0,62	2,38	2,74	2,84	10,90	12,54	95	A++	8,16	8,70	373	A+	4,26	6,46	2120	5,00	1,46	A++++	5,77	3,70	898	3,70	0
0,63	2,34	2,67	2,88	10,71	12,22	95	A++	8,15	9,00	387	A+	4,30	6,46	2104	5,01	1,45	A++++	5,74	3,80	927	3,80	0
0,67	2,29	2,65	3,05	10,49	12,13	95	A++	8,17	9,00	386	A+	4,33	6,46	2088	5,01	1,45	A++++	5,70	3,90	957	3,90	0
0,62	2,48	2,79	2,84	11,36	12,77	95	A++	8,18	8,50	364	A+	4,20	6,46	2154	4,99	1,47	A++++	5,84	3,60	862	3,60	0
0,64	2,46	2,79	2,93	11,26	12,77	95	A++	8,13	9,00	388	A+	4,21	6,46	2146	5,00	1,46	A++++	5,84	3,60	862	3,60	0
0,67	2,36	2,74	3,05	10,81	12,54	95	A++	8,13	9,00	388	A+	4,28	6,46	2112	5,01	1,45	A++++	5,78	3,80	920	3,80	0
0,68	2,32	2,66	3,10	10,62	12,17	95	A++	8,15	9,00	387	A+	4,31	6,46	2096	5,01	1,45	A++++	5,75	3,80	925	3,80	0
0,74	2,28	2,65	3,40	10,44	12,13	95	A++	8,16	9,00	386	A+	4,34	6,46	2080	5,02	1,44	A++++	5,71	3,90	955	3,90	0
0,69	2,44	2,79	3,14	11,17	12,77	95	A++	8,14	9,00	387	A+	4,23	6,46	2137	5,00	1,46	A++++	5,85	3,70	885	3,70	0
0,71	2,34	2,74	3,27	10,71	12,54	95	A++	8,14	9,00	387	A+	4,30	6,46	2103	5,01	1,45	A++++	5,79	3,80	918	3,80	0
0,72	2,30	2,66	3,31	10,53	12,17	95	A++	8,15	9,00	387	A+	4,33	6,46	2088	5,02	1,44	A++++	5,76	3,90	948	3,90	0
0,76	2,26	2,65	3,48	10,35	12,13	95	A++	8,17	9,00	386	A+	4,36	6,46	2072	5,02	1,44	A++++	5,72	3,90	953	3,90	0
0,71	2,33	2,70	3,27	10,67	12,36	95	A++	8,19	9,00	385	A+	4,31	6,46	2095	5,02	1,44	A++++	5,80	3,80	916	3,80	0
0,72	2,28	2,67	3,31	10,44	12,22	95	A++	8,20	9,00	384	A+	4,34	6,46	2080	5,02	1,44	A++++	5,77	3,90	946	3,90	0
0,79	2,24	2,65	3,61	10,26	12,13	95	A++	8,21	9,00	384	A+	4,38	6,46	2065	5,02	1,44	A++++	5,73	4,00	976	4,00	0
0,75	2,27	2,59	3,44	10,39	11,85	95	A++	8,21	9,00	384	A+	4,36	6,46	2072	5,02	1,44	A++++	5,78	3,90	944	3,90	0
0,49	2,31	2,54	2,24	10,58	11,62	95	A+++	8,57	7,50	307	A+	4,15	6,46	2176	4,98	1,48	A++++	5,85	3,50	837	3,50	0
0,54	2,42	2,54	2,45	11,08	11,62	95	A+++	8,44	7,50	311	A+	4,17	6,46	2167	4,99	1,47	A++++	5,85	3,50	838	3,50	0
0,57	2,40	2,80	2,62	10,99	12,81	95	A++	8,39	8,00	334	A+	4,18	6,46	2161	4,99	1,47	A++++	5,84	3,60	863	3,60	0
0,59	2,38	2,79	2,71	10,90	12,77	95	A++	8,18	8,50	364	A+	4,20	6,46	2153	5,00	1,46	A++++	5,84	3,60	864	3,60	0
0,62	2,35	2,74	2,84	10,76	12,54	95	A++	8,15	8,70	374	A+	4,26	6,46	2119	5,01	1,45	A++++	5,77	3,70	897	3,70	0
0,63	2,31	2,67	2,88	10,58	12,22	95	A++	8,15	9,00	387	A+	4,30	6,46	2103	5,01	1,45	A++++	5,74	3,80	927	3,80	0
0,67	2,29	2,65	3,05	10,49	12,13	95	A++	8,17	9,00	386	A+	4,33	6,46	2087	5,02	1,44	A++++	5,71	3,90	957	3,90	0
0,55	2,51	2,54	2,54	11,49	11,62	95	A++	8,35	8,00	336	A+	4,19	6,46	2158	4,99	1,47	A++++	5,86	3,50	836	3,50	0
0,59	2,47	2,80	2,71	11,31	12,81	95	A++	8,37	8,00	335	A+	4,20	6,46	2153	5,00	1,46	A++++	5,85	3,60	861	3,60	0
0,62	2,45	2,79	2,84	11,22	12,77	95	A++	8,17	8,50	364	A+	4,21	6,46	2145	5,00	1,46	A++++	5,85	3,60	862	3,60	0
0,64	2,36	2,74	2,93	10,81	12,54	95	A++	8,14	9,00	387	A+	4,28	6,46	2111	5,01	1,45	A++++	5,78	3,80	919	3,80	0
0,65	2,31	2,67	2,97	10,58	12,22	95	A++	8,16	9,00	386	A+	4,31	6,46	2095	5,02	1,44	A++++	5,75	3,80	925	3,80	0
0,70	2,27	2,65	3,18	10,39	12,13	95	A++	8,17	9,00	386	A+	4,35	6,46	2079	5,02	1,44	A++++	5,72	3,90	955	3,90	0
0,64	2,45	2,79	2,93	11,22	12,77	95	A++	8,15	8,70	374	A+	4,21	6,46	2144	5,00	1,46	A++++	5,86	3,60	860	3,60	0
0,69	2,43	2,79	3,14	11,13	12,77	95	A++	8,14	9,00	387	A+	4,23	6,46	2136	5,00	1,46	A++++	5,86	3,70	884	3,70	0
0,69	2,34	2,74	3,14	10,71	12,54	95	A++	8,14	9,00	387	A+	4,30	6,46	2102	5,02	1,44	A++++	5,80	3,80	918	3,80	0
0,70	2,30	2,66	3,18	10,53	12,17	95	A++	8,15	9,00	387	A+	4,33	6,46	2087	5,02	1,44	A++++	5,76	3,90	947	3,90	0
0,76	2,25	2,65	3,48	10,30	12,13	95	A++	8,17	9,00	386	A+	4,36	6,46	2071	5,02	1,44	A++++	5,73	3,90	953	3,90	0
0,71	2,41	2,79	3,23	11,03	12,77	95	A++	8,15	9,00	387	A+	4,25	6,46	2128	5,01	1,45	A++++	5,87	3,70	882	3,70	0
0,73	2,32	2,74	3,36	10,62	12,54	95	A++	8,14	9,00	387	A+	4,31	6,46	2094	5,02	1,44	A++++	5,81	3,80	916	3,80	0
0,74	2,28	2,66	3,40	10,44	12,17	95	A++	8,16	9,00	386	A+	4,35	6,46	2079	5,02	1,44	A++++	5,77	3,90	945	3,90	

Combinatietabellen

Binnennunit	Koelcapaciteit [kW]					Totale koelcapaciteit [kW]			Opgenomen vermogen koelen [kW]			Totale stroom koelen [A]			Verwarmingscapaciteit [kW]					Totale verwarmingscapaciteit [kW]		
	Kamer A	Kamer B	Kamer C	Kamer D	Kamer E	Min.	Nom.	Max.	Min.	Nom.	Max.	Min.	Nom.	Max.	Kamer A	Kamer B	Kamer C	Kamer D	Kamer E	Min.	Nom.	Max.
1,5+2,5+2,5+6,0	1,08	1,80	1,80	4,32	---	3,21	9,00	10,16	0,59	2,36	3,01	2,69	10,80	13,90	1,20	2,00	2,00	4,80	---	4,21	10,00	11,53
1,5+2,5+2,5+7,1	0,99	1,65	1,65	4,70	---	3,41	9,00	10,18	0,56	2,36	3,01	2,70	10,80	13,90	1,10	1,84	1,84	5,22	---	4,53	10,00	11,56
1,5+2,5+3,5+3,5	1,23	2,05	2,86	2,86	---	2,99	9,00	9,39	0,56	2,41	2,61	2,57	11,10	12,00	1,36	2,27	3,18	3,18	---	3,77	10,00	11,17
1,5+2,5+3,5+4,2	1,15	1,92	2,69	3,23	---	3,10	9,00	9,51	0,59	2,41	2,68	2,69	11,10	12,30	1,28	2,14	2,99	3,59	---	3,98	10,00	11,17
1,5+2,5+3,5+5,0	1,08	1,80	2,52	3,60	---	3,21	9,00	9,75	0,59	2,36	2,75	2,69	10,80	12,70	1,20	2,00	2,80	4,00	---	4,21	10,00	11,30
1,5+2,5+3,5+6,0	1,00	1,67	2,33	4,00	---	3,41	9,00	10,19	0,56	2,35	3,02	2,70	10,80	13,90	1,11	1,85	2,59	4,44	---	4,50	10,00	11,54
1,5+2,5+3,5+7,1	0,92	1,54	2,16	4,38	---	3,60	9,00	10,21	0,60	2,35	3,02	2,80	10,80	13,90	1,03	1,71	2,40	4,86	---	4,81	10,00	11,58
1,5+2,5+4,2+4,2	1,09	1,81	3,05	3,05	---	3,20	9,00	9,62	0,59	2,41	2,74	2,69	11,10	12,60	1,21	2,02	3,39	3,39	---	4,18	10,00	11,18
1,5+2,5+4,2+5,0	1,02	1,70	2,86	3,41	---	3,41	9,00	9,76	0,56	2,36	2,75	2,70	10,80	12,70	1,14	1,89	3,18	3,79	---	4,41	10,00	11,32
1,5+2,5+4,2+6,0	0,95	1,58	2,66	3,80	---	3,60	9,00	10,20	0,60	2,35	3,02	2,80	10,80	13,90	1,06	1,76	2,96	4,23	---	4,70	10,00	11,55
1,5+2,5+4,2+7,1	0,88	1,47	2,47	4,18	---	3,78	9,00	10,71	0,63	2,35	3,36	3,00	10,80	15,50	0,98	1,63	2,75	4,64	---	5,02	10,00	11,59
1,5+2,5+5,0+5,0	0,96	1,61	3,21	3,21	---	3,20	9,00	9,53	0,59	2,31	2,57	2,69	10,60	11,80	1,07	1,79	3,57	3,57	---	4,18	10,00	11,46
1,5+2,5+5,0+6,0	0,90	1,50	3,00	3,60	---	3,44	9,00	9,78	0,56	2,30	2,70	2,70	10,60	12,40	1,00	1,67	3,33	4,00	---	4,41	10,00	11,48
1,5+3,5+3,5+3,5	1,13	2,63	2,63	2,63	---	3,14	9,00	9,53	0,59	2,41	2,68	2,69	11,10	12,30	1,25	2,92	2,92	2,92	---	4,07	10,00	11,17
1,5+3,5+3,5+4,2	1,06	2,48	2,48	2,98	---	3,39	9,00	9,54	0,56	2,40	2,68	2,70	11,10	12,30	1,18	2,76	2,76	3,31	---	4,26	10,00	11,18
1,5+3,5+3,5+5,0	1,00	2,33	2,33	3,33	---	3,42	9,00	9,78	0,56	2,35	2,75	2,70	10,80	12,70	1,11	2,59	2,59	3,70	---	4,50	10,00	11,32
1,5+3,5+3,5+6,0	0,93	2,17	2,17	3,72	---	3,60	9,00	10,22	0,60	2,35	3,02	2,80	10,80	13,90	1,03	2,41	2,41	4,14	---	4,78	10,00	11,55
1,5+3,5+3,5+7,1	0,87	2,02	2,02	4,10	---	3,78	9,00	10,73	0,63	2,32	3,37	3,00	10,70	15,50	0,96	2,24	2,24	4,55	---	5,10	10,00	11,59
1,5+3,5+4,2+4,2	1,01	2,35	2,82	2,82	---	3,39	9,00	9,55	0,56	2,40	2,68	2,70	11,10	12,30	1,12	2,61	3,13	3,13	---	4,47	10,00	11,19
1,5+3,5+4,2+5,0	0,95	2,22	2,66	3,17	---	3,60	9,00	9,79	0,60	2,35	2,75	2,80	10,80	12,70	1,06	2,46	2,96	3,52	---	4,70	10,00	11,33
1,5+3,5+4,2+6,0	0,89	2,07	2,49	3,55	---	3,78	9,00	10,73	0,63	2,32	3,37	3,00	10,70	15,50	0,99	2,30	2,76	3,95	---	4,99	10,00	11,56
1,5+3,5+5,0+5,0	0,90	2,10	3,00	3,00	---	3,62	9,00	10,53	0,60	2,30	3,17	2,80	10,60	14,60	1,00	2,33	3,33	3,33	---	4,93	10,00	11,45
1,5+4,2+4,2+4,2	0,96	2,68	2,68	2,68	---	3,57	9,00	9,56	0,60	2,40	2,68	2,80	11,00	12,40	1,06	2,98	2,98	2,98	---	4,67	10,00	11,20
1,5+4,2+4,2+5,0	0,91	2,54	2,54	3,02	---	3,60	9,00	10,32	0,60	2,35	3,09	2,80	10,80	14,20	1,01	2,82	2,82	3,36	---	4,90	10,00	11,34
2,0+2,0+2,0+2,0	1,88	1,88	1,88	1,88	---	2,55	7,50	8,14	0,50	1,74	2,02	2,27	8,00	9,30	2,50	2,50	2,50	2,50	---	2,92	10,00	10,86
2,0+2,0+2,0+2,5	1,88	1,88	1,88	2,35	---	2,63	8,00	8,51	0,50	1,95	2,19	2,27	9,00	10,10	2,35	2,35	2,35	2,94	---	3,06	10,00	10,95
2,0+2,0+2,0+3,5	1,68	1,68	1,68	2,95	---	2,77	8,00	9,00	0,53	1,95	2,42	2,44	9,00	11,20	2,11	2,11	2,11	3,68	---	3,35	10,00	11,16
2,0+2,0+2,0+4,2	1,67	1,67	1,67	3,50	---	2,88	8,50	9,34	0,56	2,18	2,61	2,57	10,00	12,00	1,96	1,96	1,96	4,12	---	3,55	10,00	11,17
2,0+2,0+2,0+5,0	1,64	1,64	1,64	4,09	---	2,99	9,00	9,59	0,56	2,37	2,68	2,57	10,90	12,40	1,82	1,82	1,82	4,55	---	3,77	10,00	11,29
2,0+2,0+2,0+6,0	1,50	1,50	1,50	4,50	---	3,14	9,00	10,04	0,60	2,36	2,95	2,74	10,90	13,60	1,67	1,67	1,67	5,00	---	4,07	10,00	11,53
2,0+2,0+2,0+7,1	1,37	1,37	1,37	4,88	---	3,41	9,00	10,26	0,56	2,36	3,08	2,70	10,90	14,20	1,53	1,53	1,53	5,42	---	4,39	10,00	11,56
2,0+2,0+2,5+2,5	1,73	1,73	2,17	2,17	---	2,70	7,80	8,75	0,53	1,88	2,30	2,44	8,70	10,60	2,22	2,22	2,78	2,78	---	3,20	10,00	11,15
2,0+2,0+2,5+3,5	1,70	1,70	2,13	2,98	---	2,85	8,50	9,24	0,53	2,18	2,55	2,44	10,00	11,70	2,00	2,00	2,50	3,50	---	3,49	10,00	11,16
2,0+2,0+2,5+4,2	1,68	1,68	2,10	3,53	---	2,95	9,00	9,36	0,56	2,42	2,61	2,57	11,10	12,00	1,87	1,87	2,34	3,93	---	3,69	10,00	11,17
2,0+2,0+2,5+5,0	1,57	1,57	1,96	3,91	---	3,07	9,00	9,71	0,59	2,36	2,75	2,69	10,90	12,60	1,74	1,74	2,17	4,35	---	3,92	10,00	11,29
2,0+2,0+2,5+6,0	1,44	1,44	1,80	4,32	---	3,21	9,00	10,15	0,60	2,36	3,01	2,74	10,90	13,90	1,60	1,60	2,00	4,80	---	4,21	10,00	11,53
2,0+2,0+2,5+7,1	1,32	1,32	1,65	4,70	---	3,41	9,00	10,16	0,56	2,36	3,01	2,70	10,80	13,90	1,47	1,47	1,84	5,22	---	4,53	10,00	11,56
2,0+2,0+3,5+3,5	1,64	1,64	2,86	2,86	---	2,99	9,00	9,38	0,56	2,41	2,61	2,57	11,10	12,00	1,82	1,82	3,18	3,18	---	3,77	10,00	11,17
2,0+2,0+3,5+4,2	1,54	1,54	2,69	3,23	---	3,10	9,00	9,60	0,59	2,41	2,74	2,69	11,10	12,60	1,71	1,71	2,99	3,59	---	3,98	10,00	11,17
2,0+2,0+3,5+5,0	1,44	1,44	2,52	3,60	---	3,21	9,00	9,74	0,59	2,36	2,75	2,69	10,80	12,70	1,60	1,60	2,80	4,00	---	4,21	10,00	11,30
2,0+2,0+3,5+6,0	1,33	1,33	2,33	4,00	---	3,41	9,00	10,18	0,56	2,36	3,02	2,70	10,80	13,90	1,48	1,48	2,59	4,44	---	4,50	10,00	11,54
2,0+2,0+3,5+7,1	1,23	1,23	2,16	4,38	---	3,59	9,00	10,20	0,60	2,35	3,02	2,80	10,80	13,90	1,37	1,37	2,40	4,86	---	4,81	10,00	11,58
2,0+2,0+4,2+4,2	1,45	1,45	3,05	3,05	---	3,20	9,00	9,61	0,59	2,41	2,74	2,69	11,10	12,60	1,61	1,61	3,39	3,39	---	4,18	10,00	11,18
2,0+2,0+4,2+5,0	1,36	1,36	2,86	3,41	---	3,41	9,00	9,75	0,56	2,36	2,75	2,70	10,80	12,70	1,52	1,52	3,18	3,79	---	4,41	10,00	11,32
2,0+2,0+4,2+6,0	1,27	1,27	2,66	3,80	---	3,59	9,00	10,19	0,60	2,35	3,02	2,80	10,80	13,90	1,41	1,41	2,96	4,23	---	4,70	10,00	11,55
2,0+2,0+4,2+7,1	1,18	1,18	2,47	4,18	---	3,77	9,00	10,69	0,63	2,35	3,36	3,00	10,80	15,50	1,31	1,31	2,75	4,64	---	5,02	10,00	11,59
2,0+2,0+5,0+5,0	1,29	1,29	3,21	3,21	---	3,43	9,00	9,97	0,56	2,31	2,83	2,70	10,60	13,00	1,43	1,43	3,57	3,57	---	4,64	10,00	11,45
2,0+2,0+5,0+6,0	1,20	1,20	3,00	3,60	---	3,62	9,00	10,72	0,60	2,31	3,30	2,80	10,60	15,20	1,33	1,33	3,33	4,00	---	4,93	10,00	11,68
2,0+2,5+2,5+2,5	1,68	2,11	2,11	2,11	---	2,77	8,00	8,99	0,53	1,95	2,42	2,44	9,00	11,20	2,11	2,63	2,63	2,63	---	3,35	10,00	11,15
2,0+2,5+2,5+3,5	1,66	2,07	2,07	2,90	---	2,92	8,70	9,36	0,56	2,28	2,61	2,57	10,50	12,00	1,90	2,38	2,38	3,33	---	3,63	10,00	11,16
2,0+2,5+2,5+4,2	1,61	2,01	2,01	3,38	---	3,02	9,00	9,58	0,56	2,42	2,74	2,57	11,10	12,60	1,79	2,23	2,23	3,75	---	3,84	10,00	11,17
2,0+2,5+2,5+5,0	1,50	1,88	1,88	3,75	---	3,14	9,00	9,72	0,59	2,36	2,75	2,69	10,90	12,60	1,67	2,08	2,08	4,17	---	4,07	10,00	11,29
2,0+2,5+2,5+6,0	1,38	1,73	1,73	4,15	---	3,41	9,00	10,16	0,56	2,36	3,01	2,70	10,80	13,90	1,54	1,92	1,92	4,62	---	4,36	10,00	11,53
2,0+2,5+2,5+7,1	1,28	1,60	1,60	4,53	---	3,59	9,00	10,18	0,60	2,36	3,01	2,80	10,80	13,90	1,42	1,77	1,77	5,04	---	4,67	10,00	11,56
2,0+2,5+3,5+3,5	1,57	1,96	2,74	2,74	---	3,07	9,00	9,50	0,59	2,41	2,68	2,69	11,10	12,30	1,74	2,17	3,04	3,04	---	3,92	10,00	11,17
2,0																						

Opgenomen vermogen verwarmen [kW]			Totale stroom verwarmen [A]			Vermogensfactor (%)	Seizoensgegevens koelen				Seizoensgegevens verwarmen (gemiddeld klimaat)						Seizoensgegevens verwarmen (warm klimaat)					
Min.	Nom.	Max.	Min.	Nom.	Max.		label	SEER	Ontwerp-capaciteit	AEC	label	SCOP	Ontwerp-capaciteit	AEC	Opgegeven capaciteit bij -10°C	Capaciteit back-upverwarming bij -10°C	label	SCOP	Ontwerp-capaciteit	AEC	Opgegeven capaciteit bij +2°C	Capaciteit back-upverwarming bij +2°C
0,68	2,30	2,67	3,10	10,53	12,22	95	A++	8,16	9,00	386	A+	4,33	6,46	2085	5,03	1,43	A+++	5,74	3,90	950	3,90	0
0,74	2,25	2,65	3,40	10,30	12,13	95	A++	8,18	9,00	386	A+	4,36	6,46	2070	5,03	1,43	A+++	5,71	3,90	956	3,90	0
0,67	2,43	2,79	3,05	11,13	12,77	95	A++	8,22	9,00	384	A+	4,23	6,46	2134	5,02	1,44	A+++	5,86	3,70	884	3,70	0
0,71	2,41	2,79	3,27	11,03	12,77	95	A++	8,22	9,00	383	A+	4,25	6,46	2127	5,02	1,44	A+++	5,85	3,70	885	3,70	0
0,71	2,32	2,74	3,27	10,62	12,54	95	A++	8,22	9,00	384	A+	4,32	6,46	2093	5,03	1,43	A+++	5,79	3,80	918	3,80	0
0,72	2,28	2,66	3,31	10,44	12,17	95	A++	8,23	9,00	383	A+	4,35	6,46	2078	5,03	1,43	A+++	5,76	3,90	948	3,90	0
0,79	2,24	2,65	3,61	10,26	12,13	95	A++	8,25	9,00	382	A+	4,38	6,46	2062	5,04	1,42	A+++	5,72	4,00	978	4,00	0
0,73	2,40	2,79	3,36	10,99	12,77	95	A++	8,23	9,00	383	A+	4,27	6,46	2118	5,02	1,44	A+++	5,86	3,70	883	3,70	0
0,76	2,31	2,74	3,48	10,58	12,54	95	A++	8,22	9,00	383	A+	4,33	6,46	2085	5,03	1,43	A+++	5,80	3,90	941	3,90	0
0,77	2,26	2,66	3,53	10,35	12,17	95	A++	8,24	9,00	383	A+	4,37	6,46	2070	5,04	1,42	A+++	5,77	3,90	946	3,90	0
0,85	2,22	2,65	3,87	10,17	12,13	95	A++	8,25	9,00	382	A+	4,40	6,46	2055	5,04	1,42	A+++	5,73	4,00	976	4,00	0
0,73	2,29	2,79	3,36	10,49	12,77	95	A++	8,23	9,00	383	A+	4,35	6,46	2077	5,04	1,42	A+++	5,81	3,90	939	3,90	0
0,76	2,25	2,74	3,48	10,30	12,54	95	A++	8,24	9,00	382	A+	4,38	6,46	2062	5,04	1,42	A+++	5,78	4,00	969	4,00	0
0,71	2,43	2,79	3,27	11,13	12,77	95	A++	8,21	9,00	384	A+	4,24	6,46	2132	5,05	1,41	A+++	5,86	3,70	884	3,70	0
0,76	2,41	2,79	3,48	11,03	12,77	95	A++	8,22	9,00	384	A+	4,25	6,46	2124	5,05	1,41	A+++	5,86	3,70	884	3,70	0
0,79	2,32	2,74	3,61	10,62	12,54	95	A++	8,21	9,00	384	A+	4,32	6,46	2091	5,06	1,40	A+++	5,79	3,80	918	3,80	0
0,80	2,28	2,66	3,66	10,44	12,17	95	A++	8,23	9,00	383	A+	4,35	6,46	2075	5,07	1,39	A+++	5,76	3,90	948	3,90	0
0,85	2,24	2,65	3,87	10,26	12,13	95	A++	8,24	9,00	383	A+	4,39	6,46	2060	5,07	1,39	A+++	5,72	4,00	978	4,00	0
0,78	2,40	2,78	3,57	10,99	12,72	95	A++	8,22	9,00	383	A+	4,27	6,46	2116	5,06	1,40	A+++	5,87	3,70	883	3,70	0
0,81	2,31	2,74	3,70	10,58	12,54	95	A++	8,22	9,00	384	A+	4,34	6,46	2083	5,07	1,39	A+++	5,80	3,90	941	3,90	0
0,82	2,26	2,66	3,74	10,35	12,17	95	A++	8,23	9,00	383	A+	4,37	6,46	2067	5,07	1,39	A+++	5,77	3,90	946	3,90	0
0,85	2,29	2,70	3,87	10,49	12,36	95	A++	8,22	9,00	383	A+	4,36	6,46	2075	5,07	1,39	A+++	5,82	3,90	939	3,90	0
0,84	2,38	2,78	3,83	10,90	12,72	95	A++	8,23	9,00	383	A+	4,29	6,46	2107	5,06	1,40	A+++	5,88	3,70	881	3,70	0
0,86	2,29	2,73	3,96	10,49	12,49	95	A++	8,22	9,00	383	A+	4,36	6,46	2075	5,07	1,39	A+++	5,82	3,90	939	3,90	0
0,54	2,53	2,54	2,45	11,58	11,62	95	A+++	8,58	7,50	306	A+	4,17	6,46	2166	4,99	1,47	A+++	5,87	3,50	835	3,50	0
0,55	2,51	2,54	2,54	11,49	11,62	95	A++	8,38	8,00	334	A+	4,19	6,46	2157	4,99	1,47	A+++	5,87	3,50	835	3,50	0
0,59	2,47	2,80	2,71	11,31	12,81	95	A++	8,38	8,00	335	A+	4,20	6,46	2152	5,00	1,46	A+++	5,85	3,60	861	3,60	0
0,62	2,45	2,79	2,84	11,22	12,77	95	A++	8,02	8,50	371	A+	4,21	6,46	2144	5,00	1,46	A+++	5,85	3,60	861	3,60	0
0,64	2,36	2,75	2,93	10,81	12,59	95	A++	7,93	9,00	398	A+	4,28	6,46	2110	5,02	1,44	A+++	5,79	3,80	919	3,80	0
0,65	2,31	2,67	2,97	10,58	12,22	95	A++	7,96	9,00	396	A+	4,32	6,46	2094	5,02	1,44	A+++	5,76	3,80	924	3,80	0
0,70	2,27	2,65	3,18	10,39	12,13	95	A++	7,96	9,00	396	A+	4,35	6,46	2078	5,02	1,44	A+++	5,72	3,90	954	3,90	0
0,57	2,49	2,80	2,62	11,40	12,81	95	A++	8,48	7,80	322	A+	4,19	6,46	2159	5,00	1,46	A+++	5,87	3,60	858	3,60	0
0,62	2,45	2,80	2,84	11,22	12,81	95	A++	8,02	8,50	371	A+	4,22	6,46	2143	5,00	1,46	A+++	5,87	3,60	859	3,60	0
0,64	2,43	2,79	2,93	11,13	12,77	95	A++	7,93	9,00	398	A+	4,23	6,46	2135	5,01	1,45	A+++	5,86	3,70	884	3,70	0
0,67	2,34	2,75	3,05	10,71	12,59	95	A++	7,93	9,00	397	A+	4,30	6,46	2102	5,02	1,44	A+++	5,80	3,80	917	3,80	0
0,68	2,30	2,67	3,10	10,53	12,22	95	A++	7,95	9,00	397	A+	4,33	6,46	2086	5,02	1,44	A+++	5,77	3,90	947	3,90	0
0,74	2,25	2,65	3,40	10,30	12,13	95	A++	7,97	9,00	396	A+	4,36	6,46	2070	5,03	1,43	A+++	5,73	3,90	952	3,90	0
0,67	2,43	2,79	3,05	11,13	12,77	95	A++	8,07	9,00	391	A+	4,23	6,46	2135	5,01	1,45	A+++	5,88	3,70	881	3,70	0
0,71	2,41	2,79	3,27	11,03	12,77	95	A++	8,07	9,00	391	A+	4,25	6,46	2127	5,01	1,45	A+++	5,87	3,70	882	3,70	0
0,71	2,32	2,74	3,27	10,62	12,54	95	A++	8,07	9,00	391	A+	4,32	6,46	2093	5,02	1,44	A+++	5,81	3,80	915	3,80	0
0,72	2,28	2,66	3,31	10,44	12,17	95	A++	8,08	9,00	390	A+	4,35	6,46	2078	5,03	1,43	A+++	5,78	3,90	945	3,90	0
0,79	2,24	2,65	3,61	10,26	12,13	95	A++	8,10	9,00	389	A+	4,38	6,46	2063	5,03	1,43	A+++	5,74	4,00	975	4,00	0
0,73	2,40	2,79	3,36	10,99	12,77	95	A++	8,08	9,00	390	A+	4,26	6,46	2119	5,02	1,44	A+++	5,88	3,70	880	3,70	0
0,76	2,31	2,74	3,48	10,58	12,54	95	A++	8,07	9,00	390	A+	4,33	6,46	2085	5,03	1,43	A+++	5,82	3,90	938	3,90	0
0,77	2,26	2,66	3,53	10,35	12,17	95	A++	8,09	9,00	390	A+	4,37	6,46	2070	5,03	1,43	A+++	5,79	3,90	943	3,90	0
0,85	2,22	2,65	3,87	10,17	12,13	95	A++	8,11	9,00	389	A+	4,40	6,46	2055	5,03	1,43	A+++	5,76	4,00	973	4,00	0
0,79	2,29	2,70	3,61	10,49	12,36	95	A++	8,08	9,00	390	A+	4,35	6,46	2077	5,03	1,43	A+++	5,83	3,90	936	3,90	0
0,80	2,25	2,67	3,66	10,30	12,22	95	A++	8,10	9,00	389	A+	4,38	6,46	2062	5,03	1,43	A+++	5,80	4,00	965	4,00	0
0,60	2,47	2,80	2,75	11,31	12,81	95	A++	8,40	8,00	334	A+	4,20	6,46	2149	5,01	1,45	A+++	5,86	3,60	860	3,60	0
0,64	2,43	2,80	2,93	11,13	12,81	95	A++	8,03	8,70	379	A+	4,23	6,46	2134	5,02	1,44	A+++	5,85	3,70	886	3,70	0
0,69	2,41	2,79	3,14	11,03	12,77	95	A++	7,93	9,00	398	A+	4,25	6,46	2126	5,02	1,44	A+++	5,84	3,70	886	3,70	0
0,69	2,32	2,75	3,14	10,62	12,59	95	A++	7,93	9,00	397	A+	4,32	6,46	2093	5,03	1,43	A+++	5,78	3,80	920	3,80	0
0,70	2,28	2,67	3,18	10,44	12,22	95	A++	7,95	9,00	397	A+	4,35	6,46	2077	5,04	1,42	A+++	5,75	3,90	950	3,90	0
0,77	2,24	2,65	3,53	10,26	12,13	95	A++	7,97	9,00	396	A+	4,38	6,46	2062	5,04	1,42	A+++	5,71	4,00	980	4,00	0
0,69	2,41	2,79	3,14	11,03	12,77	95	A++	8,07	9,00	391	A+	4,25	6,46	2126	5,02	1,44	A+++	5,86	3,70	884	3,70	0
0,73	2,40	2,79	3,36	10,99	12,77	95	A++	8,07	9,00	391	A+	4,27	6,46	2118	5,03	1,43	A+++	5,85	3,70	884	3,70	0
0,73	2,31	2,74	3,36	10,58	12,54	95	A++	8,07	9,00	391	A+	4,33	6,46	2085	5,04	1,42	A+++	5,79	3,90	943	3,90	0
0,77	2,26	2,66	3,53	10,35	12,17	95	A++	8,08	9,00	390	A+	4,37	6,46	2070	5,04	1,42	A+++	5,76	3,90	948	3,90	0
0,82	2,22	2,65	3,74	10,17	12,13	95	A++	8,10	9,00	389	A+	4,40	6,46	2055	5,05	1,41	A+++	5,72	4,00	978	4,00	0
0,76	2,38	2,79	3,48	10,90	12,77	95	A++	8,08	9,00	390	A+	4,28	6,46	2110	5,03	1,43	A+++	5,87	3,70	883	3,70	0
0,79	2,29	2,74	3,61	10,49	12,54	95	A++	8,07	9,00	390	A+	4,35	6,46	2077	5,04	1,42	A+++	5,80	3,90	941	3,90	

Combinatietabellen

Binnennunit	Koelcapaciteit [kW]					Totale koelcapaciteit [kW]			Opgenomen vermogen koelen [kW]			Totale stroom koelen [A]			Verwarmingcapaciteit [kW]					Totale verwarmingcapaciteit [kW]		
	Kamer A	Kamer B	Kamer C	Kamer D	Kamer E	Min.	Nom.	Max.	Min.	Nom.	Max.	Min.	Nom.	Max.	Kamer A	Kamer B	Kamer C	Kamer D	Kamer E	Min.	Nom.	Max.
2,0+3,5+5,0+5,0	1,16	2,03	2,90	2,90	---	3,80	9,00	10,53	0,63	2,30	3,17	3,00	10,60	14,60	1,29	2,26	3,23	3,23	---	5,07	10,00	11,45
2,0+4,2+4,2+4,2	1,23	2,59	2,59	2,59	---	3,57	9,00	9,56	0,60	2,40	2,68	2,80	11,00	12,40	1,37	2,88	2,88	2,88	---	4,81	10,00	11,20
2,0+4,2+4,2+5,0	1,17	2,45	2,45	2,92	---	3,78	9,00	10,22	0,63	2,35	3,02	3,00	10,80	13,90	1,30	2,73	2,73	3,25	---	5,04	10,00	11,34
2,5+2,5+2,5+2,5	2,13	2,13	2,13	2,13	---	2,85	8,50	9,23	0,53	2,18	2,55	2,44	10,00	11,70	2,50	2,50	2,50	2,50	---	3,49	10,00	11,15
2,5+2,5+2,5+3,5	2,05	2,05	2,05	2,86	---	2,99	9,00	9,37	0,56	2,42	2,61	2,57	11,10	12,00	2,27	2,27	2,27	3,18	---	3,77	10,00	11,16
2,5+2,5+2,5+4,2	1,92	1,92	1,92	3,23	---	3,10	9,00	9,59	0,59	2,42	2,74	2,69	11,10	12,60	2,14	2,14	2,14	3,59	---	3,98	10,00	11,17
2,5+2,5+2,5+5,0	1,80	1,80	1,80	3,60	---	3,21	9,00	9,73	0,59	2,36	2,75	2,69	10,90	12,60	2,00	2,00	2,00	4,00	---	4,21	10,00	11,29
2,5+2,5+2,5+6,0	1,67	1,67	1,67	4,00	---	3,41	9,00	10,17	0,56	2,36	3,01	2,70	10,80	13,90	1,85	1,85	1,85	4,44	---	4,50	10,00	11,53
2,5+2,5+2,5+7,1	1,54	1,54	1,54	4,38	---	3,59	9,00	10,19	0,60	2,36	3,02	2,80	10,80	13,90	1,71	1,71	1,71	4,86	---	4,81	10,00	11,56
2,5+2,5+3,5+3,5	1,88	1,88	2,63	2,63	---	3,14	9,00	9,51	0,59	2,41	2,68	2,69	11,10	12,30	2,08	2,08	2,92	2,92	---	4,07	10,00	11,17
2,5+2,5+3,5+4,2	1,77	1,77	2,48	2,98	---	3,39	9,00	9,52	0,56	2,41	2,68	2,70	11,10	12,30	1,97	1,97	2,76	3,31	---	4,26	10,00	11,17
2,5+2,5+3,5+5,0	1,67	1,67	2,33	3,33	---	3,41	9,00	9,76	0,56	2,36	2,75	2,70	10,80	12,70	1,85	1,85	2,59	3,70	---	4,50	10,00	11,30
2,5+2,5+3,5+6,0	1,55	1,55	2,17	3,72	---	3,60	9,00	10,20	0,60	2,35	3,02	2,80	10,80	13,90	1,72	1,72	2,41	4,14	---	4,78	10,00	11,54
2,5+2,5+3,5+7,1	1,44	1,44	2,02	4,10	---	3,78	9,00	10,71	0,63	2,35	3,36	3,00	10,80	15,50	1,60	1,60	2,24	4,55	---	5,10	10,00	11,58
2,5+2,5+4,2+4,2	1,68	1,68	2,82	2,82	---	3,39	9,00	9,53	0,56	2,41	2,68	2,70	11,10	12,30	1,87	1,87	3,13	3,13	---	4,47	10,00	11,18
2,5+2,5+4,2+5,0	1,58	1,58	2,66	3,17	---	3,59	9,00	9,77	0,60	2,35	2,75	2,80	10,80	12,70	1,76	1,76	2,96	3,52	---	4,70	10,00	11,32
2,5+2,5+4,2+6,0	1,48	1,48	2,49	3,55	---	3,78	9,00	10,70	0,63	2,35	3,36	3,00	10,80	15,50	1,64	1,64	2,76	3,95	---	4,99	10,00	11,55
2,5+2,5+5,0+5,0	1,50	1,50	3,00	3,00	---	3,62	9,00	10,51	0,60	2,31	3,16	2,80	10,60	14,60	1,67	1,67	3,33	3,33	---	4,93	10,00	11,45
2,5+3,5+3,5+3,5	1,73	2,42	2,42	2,42	---	3,39	9,00	9,54	0,56	2,40	2,68	2,70	11,10	12,30	1,92	2,69	2,69	2,69	---	4,36	10,00	11,17
2,5+3,5+3,5+4,2	1,64	2,30	2,30	2,76	---	3,39	9,00	9,55	0,56	2,40	2,68	2,70	11,00	12,30	1,82	2,55	2,55	3,07	---	4,55	10,00	11,18
2,5+3,5+3,5+5,0	1,55	2,17	2,17	3,10	---	3,60	9,00	9,79	0,60	2,35	2,75	2,80	10,80	12,70	1,72	2,41	2,41	3,45	---	4,78	10,00	11,32
2,5+3,5+3,5+6,0	1,45	2,03	2,03	3,48	---	3,78	9,00	10,63	0,63	2,32	3,30	3,00	10,70	15,20	1,61	2,26	2,26	3,87	---	5,07	10,00	11,55
2,5+3,5+4,2+4,2	1,56	2,19	2,63	2,63	---	3,57	9,00	9,56	0,60	2,40	2,68	2,80	11,00	12,40	1,74	2,43	2,92	2,92	---	4,75	10,00	11,19
2,5+3,5+4,2+5,0	1,48	2,07	2,49	2,96	---	3,78	9,00	10,22	0,63	2,35	3,02	3,00	10,80	13,90	1,64	2,30	2,76	3,29	---	4,99	10,00	11,33
2,5+4,2+4,2+4,2	1,49	2,50	2,50	2,50	---	3,75	9,00	10,09	0,63	2,37	3,01	3,00	10,90	13,80	1,66	2,78	2,78	2,78	---	4,96	10,00	11,20
3,5+3,5+3,5+3,5	2,25	2,25	2,25	2,25	---	3,58	9,00	9,58	0,60	2,37	2,68	2,80	10,90	12,40	2,50	2,50	2,50	2,50	---	4,64	10,00	11,18
3,5+3,5+3,5+4,2	2,14	2,14	2,14	2,57	---	3,58	9,00	10,11	0,60	2,37	3,01	2,80	10,90	13,80	2,38	2,38	2,38	2,86	---	4,85	10,00	11,19
3,5+3,5+3,5+5,0	2,03	2,03	2,03	2,90	---	3,78	9,00	10,24	0,63	2,32	3,02	3,00	10,70	13,90	2,26	2,26	2,26	3,23	---	5,07	10,00	11,33
3,5+3,5+4,2+4,2	2,05	2,05	2,45	2,45	---	3,76	9,00	10,12	0,63	2,37	3,01	3,00	10,90	13,80	2,27	2,27	2,73	2,73	---	5,04	10,00	11,20
1,5+1,5+1,5+1,5+1,5	1,50	1,50	1,50	1,50	1,50	2,48	7,50	7,81	0,48	1,65	1,76	2,19	7,60	8,10	2,00	2,00	2,00	2,00	2,00	2,77	10,00	10,90
1,5+1,5+1,5+1,5+2,0	1,41	1,41	1,41	1,41	1,88	2,55	7,50	8,22	0,48	1,65	1,92	2,19	7,60	8,90	1,88	1,88	1,88	1,88	2,50	2,92	10,00	10,90
1,5+1,5+1,5+1,5+2,5	1,41	1,41	1,41	1,41	2,35	2,63	8,00	8,49	0,51	1,85	2,03	2,32	8,50	9,40	1,76	1,76	1,76	1,76	2,94	3,06	10,00	10,90
1,5+1,5+1,5+1,5+3,5	1,26	1,26	1,26	1,26	2,95	2,77	8,00	9,02	0,53	1,84	2,27	2,44	8,50	10,40	1,58	1,58	1,58	1,58	3,68	3,35	10,00	11,55
1,5+1,5+1,5+1,5+4,2	1,32	1,32	1,32	1,32	3,71	2,88	9,00	9,39	0,53	2,26	2,45	2,44	10,40	11,30	1,47	1,47	1,47	1,47	4,12	3,55	10,00	11,55
1,5+1,5+1,5+1,5+5,0	1,23	1,23	1,23	1,23	4,09	2,99	9,00	9,70	0,56	2,25	2,58	2,57	10,40	11,90	1,36	1,36	1,36	1,36	4,55	3,77	10,00	11,69
1,5+1,5+1,5+1,5+6,0	1,13	1,13	1,13	1,13	4,50	3,14	9,00	10,06	0,57	2,25	2,78	2,61	10,30	12,80	1,25	1,25	1,25	1,25	5,00	4,07	10,00	11,93
1,5+1,5+1,5+1,5+7,1	1,03	1,03	1,03	1,03	4,88	3,48	9,00	10,39	0,56	2,25	2,98	2,60	10,30	13,70	1,15	1,15	1,15	1,15	5,42	4,39	10,00	11,96
1,5+1,5+1,5+2,0+2,0	1,41	1,41	1,41	1,88	1,88	2,63	8,00	8,48	0,51	1,85	2,03	2,32	8,50	9,40	1,76	1,76	1,76	2,35	2,35	3,06	10,00	10,90
1,5+1,5+1,5+2,0+2,5	1,33	1,33	1,33	1,78	2,22	2,70	8,00	8,75	0,51	1,85	2,15	2,32	8,50	9,90	1,67	1,67	1,67	2,22	2,78	3,20	10,00	11,54
1,5+1,5+1,5+2,0+3,5	1,28	1,28	1,28	1,70	2,98	2,85	8,50	9,26	0,53	2,03	2,39	2,44	9,40	11,00	1,50	1,50	1,50	2,00	3,50	3,49	10,00	11,55
1,5+1,5+1,5+2,0+4,2	1,26	1,26	1,26	1,68	3,53	2,95	9,00	9,63	0,53	2,26	2,58	2,44	10,40	11,90	1,40	1,40	1,40	1,87	3,93	3,69	10,00	11,55
1,5+1,5+1,5+2,0+5,0	1,17	1,17	1,17	1,57	3,91	3,07	9,00	9,93	0,56	2,25	2,71	2,57	10,40	12,50	1,30	1,30	1,30	1,74	4,35	3,92	10,00	11,69
1,5+1,5+1,5+2,0+6,0	1,08	1,08	1,08	1,44	4,32	3,21	9,00	10,17	0,57	2,25	2,84	2,61	10,30	13,10	1,20	1,20	1,20	1,60	4,80	4,21	10,00	11,93
1,5+1,5+1,5+2,0+7,1	0,99	0,99	0,99	1,32	4,70	3,48	9,00	10,50	0,56	2,25	3,04	2,60	10,30	14,00	1,10	1,10	1,10	1,47	5,22	4,53	10,00	11,96
1,5+1,5+1,5+2,5+2,5	1,26	1,26	1,26	2,11	2,11	2,77	8,00	9,01	0,53	1,84	2,27	2,44	8,50	10,40	1,58	1,58	1,58	2,63	2,63	3,35	10,00	11,54
1,5+1,5+1,5+2,5+3,5	1,24	1,24	1,24	2,07	2,90	2,92	8,70	9,51	0,53	2,13	2,51	2,44	9,80	11,60	1,43	1,43	1,43	2,38	3,33	3,63	10,00	11,55
1,5+1,5+1,5+2,5+4,2	1,21	1,21	1,21	2,01	3,38	3,02	9,00	9,75	0,56	2,26	2,64	2,57	10,40	12,20	1,34	1,34	1,34	2,23	3,75	3,84	10,00	11,55
1,5+1,5+1,5+2,5+5,0	1,13	1,13	1,13	1,88	3,75	3,14	9,00	10,05	0,56	2,25	2,78	2,57	10,40	12,80	1,25	1,25	1,25	2,08	4,17	4,07	10,00	11,69
1,5+1,5+1,5+2,5+6,0	1,04	1,04	1,04	1,73	4,15	3,29	9,00	10,39	0,60	2,25	2,98	2,74	10,30	13,70	1,15	1,15	1,15	1,92	4,62	4,36	10,00	11,93
1,5+1,5+1,5+2,5+7,1	0,96	0,96	0,96	1,60	4,53	3,48	9,00	10,61	0,56	2,25	3,11	2,60	10,30	14,30	1,06	1,06	1,06	1,77	5,04	4,67	10,00	11,96
1,5+1,5+1,5+3,5+3,5	1,17	1,17	1,17	2,74	2,74	3,07	9,00	9,88	0,56	2,26	2,71	2,57	10,40	12,50	1,30	1,30	1,30	3,04	3,04	3,92	10,00	11,55
1,5+1,5+1,5+3,5+4,2	1,11	1,11	1,11	2,58	3,10	3,17	9,00	10,11	0,60	2,26	2,84	2,74	10,40	13,00	1,23	1,23	1,23	2,87	3,44	4,12	10,00	11,56
1,5+1,5+1,5+3,5+5,0	1,04	1,04	1,04	2,42	3,46	3,29	9,00	10,40	0,60	2,25	2,98	2,74	10,30	13,70	1,15	1,15	1,15	2,69	3,85	4,36	10,00	11,70
1,5+1,5+1,5+3,5+6,0	0,96	0,96	0,96																			

Opgenomen vermogen verwarmen [kW]			Totale stroom verwarmen [A]			Vermogens-factor [%]	Seizoensgegevens koelen				Seizoensgegevens verwarmen (gemiddeld klimaat)						Seizoensgegevens verwarmen (warm klimaat)					
Min.	Nom.	Max.	Min.	Nom.	Max.		label	SEER	Ontwerp-capaciteit	AEC	label	SCOP	Ontwerp-capaciteit	AEC	Opgegeven capaciteit bij -10°C	Capaciteit back-upverwarming bij -10°C	label	SCOP	Ontwerp-capaciteit	AEC	Opgegeven capaciteit bij +2°C	Capaciteit back-upverwarming bij +2°C
0,86	2,29	2,70	3,96	10,49	12,36	95	A++	8,09	9,00	390	A+	4,36	6,46	2075	5,08	1,38	A+++	5,80	3,90	940	3,90	0
0,86	2,36	2,78	3,96	10,81	12,72	95	A++	8,10	9,00	389	A+	4,30	6,46	2099	5,07	1,39	A+++	5,88	3,80	905	3,80	0
0,89	2,27	2,73	4,09	10,39	12,49	95	A++	8,09	9,00	389	A+	4,37	6,46	2067	5,08	1,38	A+++	5,82	3,90	938	3,90	0
0,62	2,45	2,80	2,84	11,22	12,81	95	A++	8,07	8,50	369	A+	4,22	6,46	2141	5,02	1,44	A+++	5,86	3,60	860	3,60	0
0,67	2,41	2,80	3,05	11,03	12,81	95	A++	8,04	9,00	392	A+	4,25	6,46	2125	5,03	1,43	A+++	5,85	3,70	886	3,70	0
0,71	2,40	2,79	3,27	10,99	12,77	95	A++	8,05	9,00	392	A+	4,27	6,46	2118	5,03	1,43	A+++	5,84	3,70	886	3,70	0
0,71	2,31	2,75	3,27	10,58	12,59	95	A++	8,04	9,00	392	A+	4,33	6,46	2085	5,04	1,42	A+++	5,78	3,90	944	3,90	0
0,72	2,26	2,67	3,31	10,35	12,22	95	A++	8,06	9,00	391	A+	4,37	6,46	2069	5,05	1,41	A+++	5,75	3,90	950	3,90	0
0,79	2,22	2,65	3,61	10,17	12,13	95	A++	8,08	9,00	390	A+	4,40	6,46	2054	5,05	1,41	A+++	5,71	4,00	980	4,00	0
0,71	2,40	2,79	3,27	10,99	12,77	95	A++	8,05	9,00	392	A+	4,27	6,46	2117	5,03	1,43	A+++	5,86	3,70	884	3,70	0
0,76	2,38	2,79	3,48	10,90	12,77	95	A++	8,05	9,00	391	A+	4,28	6,46	2109	5,03	1,43	A+++	5,86	3,70	884	3,70	0
0,79	2,29	2,74	3,61	10,49	12,54	95	A++	8,05	9,00	391	A+	4,35	6,46	2077	5,05	1,41	A+++	5,79	3,90	942	3,90	0
0,80	2,25	2,66	3,66	10,30	12,17	95	A++	8,07	9,00	391	A+	4,38	6,46	2062	5,05	1,41	A+++	5,76	4,00	972	4,00	0
0,85	2,21	2,65	3,87	10,12	12,13	95	A++	8,09	9,00	390	A+	4,41	6,46	2047	5,05	1,41	A+++	5,72	4,00	978	4,00	0
0,79	2,36	2,79	3,61	10,81	12,77	95	A++	8,06	9,00	391	A+	4,30	6,46	2101	5,04	1,42	A+++	5,87	3,80	907	3,80	0
0,82	2,27	2,74	3,74	10,39	12,54	95	A++	8,06	9,00	391	A+	4,37	6,46	2069	5,05	1,41	A+++	5,80	3,90	940	3,90	0
0,82	2,23	2,66	3,74	10,21	12,17	95	A++	8,08	9,00	390	A+	4,40	6,46	2054	5,05	1,41	A+++	5,77	4,00	970	4,00	0
0,85	2,25	2,70	3,87	10,30	12,36	95	A++	8,07	9,00	391	A+	4,38	6,46	2061	5,05	1,41	A+++	5,82	3,90	938	3,90	0
0,79	2,40	2,79	3,61	10,99	12,77	95	A++	8,07	9,00	390	A+	4,27	6,46	2114	5,06	1,40	A+++	5,86	3,70	883	3,70	0
0,81	2,38	2,79	3,70	10,90	12,77	95	A++	8,08	9,00	390	A+	4,29	6,46	2107	5,07	1,39	A+++	5,86	3,70	884	3,70	0
0,84	2,29	2,74	3,83	10,49	12,54	95	A++	8,07	9,00	390	A+	4,36	6,46	2074	5,08	1,38	A+++	5,79	3,90	942	3,90	0
0,85	2,25	2,66	3,87	10,30	12,17	95	A++	8,09	9,00	390	A+	4,39	6,46	2059	5,08	1,38	A+++	5,76	4,00	972	4,00	0
0,86	2,36	2,78	3,96	10,81	12,72	95	A++	8,08	9,00	390	A+	4,31	6,46	2099	5,07	1,39	A+++	5,87	3,80	906	3,80	0
0,86	2,27	2,74	3,96	10,39	12,54	95	A++	8,08	9,00	390	A+	4,37	6,46	2066	5,08	1,38	A+++	5,81	3,90	940	3,90	0
0,89	2,34	2,78	4,09	10,71	12,72	95	A++	8,09	9,00	390	A+	4,32	6,46	2091	5,08	1,38	A+++	5,88	3,80	904	3,80	0
0,84	2,33	2,79	3,83	10,67	12,77	95	A++	8,08	9,00	390	A+	4,33	6,46	2085	5,07	1,39	A+++	5,88	3,70	881	3,70	0
0,86	2,31	2,78	3,96	10,58	12,72	95	A++	8,08	9,00	390	A+	4,35	6,46	2077	5,07	1,39	A+++	5,87	3,80	905	3,80	0
0,89	2,23	2,74	4,09	10,21	12,54	95	A++	8,08	9,00	390	A+	4,42	6,46	2046	5,08	1,38	A+++	5,81	3,90	939	3,90	0
0,92	2,30	2,78	4,22	10,53	12,72	95	A++	8,09	9,00	390	A+	4,37	6,46	2069	5,08	1,38	A+++	5,89	3,80	904	3,80	0
0,42	2,14	2,47	1,94	9,80	11,30	95	A++	7,90	7,50	333	A+	4,25	6,46	2127	5,22	1,24	A+++	5,45	3,10	796	3,10	0
0,44	2,13	2,47	2,02	9,75	11,30	95	A++	7,89	7,50	333	A+	4,26	6,46	2119	5,22	1,24	A+++	5,45	3,20	822	3,20	0
0,48	2,11	2,47	2,19	9,66	11,30	95	A++	7,80	8,00	359	A+	4,28	6,46	2111	5,23	1,23	A+++	5,44	3,20	823	3,20	0
0,52	2,08	2,77	2,37	9,52	12,17	95	A++	7,81	8,00	359	A+	4,31	6,46	2096	5,23	1,23	A+++	5,43	3,30	850	3,30	0
0,55	2,07	2,77	2,54	9,48	12,17	95	A++	7,66	9,00	411	A+	4,33	6,46	2088	5,24	1,22	A+++	5,43	3,30	851	3,30	0
0,56	2,00	2,78	2,58	9,16	12,22	95	A++	7,69	9,00	410	A+	4,40	6,46	2055	5,25	1,21	A+++	5,36	3,40	888	3,40	0
0,56	1,99	2,70	2,58	9,11	11,85	95	A++	7,71	9,00	409	A+	4,42	6,46	2043	5,25	1,21	A+++	5,32	3,50	920	3,50	0
0,62	1,96	2,68	2,84	8,98	11,76	95	A++	7,73	9,00	408	A+	4,43	6,46	2039	5,26	1,20	A+++	5,28	3,60	953	3,60	0
0,48	2,11	2,57	2,19	9,66	11,30	95	A++	7,80	8,00	359	A+	4,28	6,46	2110	5,23	1,23	A+++	5,46	3,20	820	3,20	0
0,50	2,10	2,77	2,28	9,62	12,17	95	A++	7,80	8,00	359	A+	4,30	6,46	2102	5,23	1,23	A+++	5,46	3,20	821	3,20	0
0,54	2,07	2,77	2,45	9,48	12,17	95	A++	7,76	8,50	383	A+	4,33	6,46	2087	5,24	1,22	A+++	5,44	3,30	848	3,30	0
0,58	2,06	2,77	2,67	9,43	12,17	95	A++	7,81	9,00	404	A+	4,35	6,46	2079	5,24	1,22	A+++	5,44	3,30	849	3,30	0
0,58	1,99	2,78	2,67	9,11	12,22	95	A++	7,83	9,00	403	A+	4,42	6,46	2046	5,25	1,21	A+++	5,37	3,50	912	3,50	0
0,61	1,96	2,70	2,80	8,98	11,85	95	A++	7,85	9,00	402	A+	4,45	6,46	2031	5,26	1,20	A+++	5,33	3,50	918	3,50	0
0,65	1,93	2,68	2,97	8,84	11,76	95	A++	7,86	9,00	401	A+	4,48	6,46	2018	5,26	1,20	A+++	5,30	3,60	950	3,60	0
0,52	2,08	2,77	2,37	9,52	12,17	95	A++	7,81	8,00	359	A+	4,32	6,46	2094	5,23	1,23	A+++	5,47	3,30	845	3,30	0
0,56	2,06	2,77	2,58	9,43	12,17	95	A++	7,71	8,70	395	A+	4,35	6,46	2078	5,24	1,22	A+++	5,46	3,30	847	3,30	0
0,60	2,04	2,77	2,75	9,34	12,17	95	A++	7,66	9,00	411	A+	4,36	6,46	2071	5,24	1,22	A+++	5,45	3,30	847	3,30	0
0,62	1,98	2,78	2,84	9,07	12,22	95	A++	7,69	9,00	410	A+	4,43	6,46	2038	5,26	1,20	A+++	5,38	3,50	910	3,50	0
0,63	1,95	2,70	2,88	8,93	11,85	95	A++	7,70	9,00	409	A+	4,44	6,46	2034	5,26	1,20	A+++	5,35	3,60	943	3,60	0
0,67	1,92	2,68	3,05	8,79	11,76	95	A++	7,72	9,00	408	A+	4,47	6,46	2022	5,26	1,20	A+++	5,31	3,60	949	3,60	0
0,62	2,04	2,77	2,84	9,34	12,17	95	A++	7,68	9,00	411	A+	4,37	6,46	2070	5,24	1,22	A+++	5,47	3,30	845	3,30	0
0,65	2,03	2,77	2,97	9,30	12,17	95	A++	7,68	9,00	410	A+	4,38	6,46	2062	5,25	1,21	A+++	5,46	3,40	871	3,40	0
0,67	1,97	2,77	3,05	9,02	12,17	95	A++	7,70	9,00	409	A+	4,45	6,46	2030	5,26	1,20	A+++	5,39	3,50	908	3,50	0
0,68	1,94	2,69	3,10	8,88	11,81	95	A++	7,72	9,00	408	A+	4,46	6,46	2027	5,26	1,20	A+++	5,36	3,60	940	3,60	0
0,74	1,91	2,68	3,40	8,75	11,76	95	A++	7,74	9,00	407	A+	4,48	6,46	2015	5,27	1,19	A+++	5,32	3,70	973	3,70	0
0,69	2,02	2,76	3,14	9,25	12,13	95	A++	7,69	9,00	410	A+	4,40	6,46	2054	5,25	1,21	A+++	5,47	3,40	869	3,40	0
0,71	1,97	2,77	3,27	9,02	12,17	95	A++	7,71	9,00	409	A+	4,44	6,46	2037	5,26	1,20	A+++	5,40	3,50	907	3,50	0
0,72	1,91	2,69	3,31	8,75	11,81	95	A++	7,73	9,00	408	A+	4,49	6,46	2013	5,27	1,19	A+++	5,37	3,60	938	3,60	0
0,71	1,90	2,73	3,27	8,70	11,95	95	A++	7,72	9,00	408	A+	4,52	6,46	2000	5,27	1,19	A+++	5,43	3,60	928	3,60	0
0,74	1,87	2,64	3,40	8,56	11,58	95	A++	7,74	9,00	407	A+	4,55	6,46	1987	5,27	1,19	A+++	5,40	3,60	934	3,60	0
0,50	2,10	2,77	2,28	9,62	12,17	95	A++	7,86	7,80	348	A+	4,30	6,46	2103	5,22	1,24	A+++	5,42	3,20	826	3,20	0
0,52	2,09	2,																				

Combinatietabellen

Binnenuit	Koelcapaciteit [kW]					Totale koelcapaciteit [kW]			Opgenomen vermogen koelen [kW]			Totale stroom koelen [A]			Verwarmingscapaciteit [kW]					Totale verwarmingscapaciteit [kW]			
	Kamer A	Kamer B	Kamer C	Kamer D	Kamer E	Min.	Nom.	Max.	Min.	Nom.	Max.	Min.	Nom.	Max.	Kamer A	Kamer B	Kamer C	Kamer D	Kamer E	Min.	Nom.	Max.	
1,5+1,5+2,0+2,5+5,0	1,08	1,08	1,44	1,80	3,60	3,21	9,00	10,16	0,60	2,25	2,84	2,74	10,40	13,10	1,20	1,20	1,60	2,00	4,00	4,21	10,00	11,69	
1,5+1,5+2,0+2,5+6,0	1,00	1,00	1,33	1,67	4,00	3,48	9,00	10,50	0,56	2,25	3,04	2,60	10,30	14,00	1,11	1,11	1,48	1,85	4,44	4,50	10,00	11,93	
1,5+1,5+2,0+2,5+7,1	0,92	0,92	1,23	1,54	4,38	3,67	9,00	10,61	0,59	2,25	3,11	2,80	10,30	14,30	1,03	1,03	1,37	1,71	4,86	4,81	10,00	11,96	
1,5+1,5+2,0+3,5+3,5	1,13	1,13	1,50	2,63	2,63	3,14	9,00	10,10	0,56	2,26	2,84	2,57	10,40	13,00	1,25	1,25	1,67	2,92	2,92	4,07	10,00	11,55	
1,5+1,5+2,0+3,5+4,2	1,06	1,06	1,42	2,48	2,98	3,24	9,00	10,22	0,60	2,26	2,90	2,74	10,40	13,40	1,18	1,18	1,57	2,76	3,31	4,26	10,00	11,56	
1,5+1,5+2,0+3,5+5,0	1,00	1,00	1,33	2,33	3,33	3,48	9,00	10,40	0,56	2,25	2,98	2,60	10,30	13,70	1,11	1,11	1,48	2,59	3,70	4,50	10,00	11,70	
1,5+1,5+2,0+3,5+6,0	0,93	0,93	1,24	2,17	3,72	3,67	9,00	10,62	0,59	2,25	3,11	2,80	10,30	14,30	1,03	1,03	1,38	2,41	4,14	4,78	10,00	11,94	
1,5+1,5+2,0+3,5+7,1	0,87	0,87	1,15	2,02	4,10	3,67	9,00	10,73	0,59	2,25	3,18	2,80	10,30	14,60	0,96	0,96	1,28	2,24	4,55	5,10	10,00	11,97	
1,5+1,5+2,0+4,2+4,2	1,01	1,01	1,34	2,82	2,82	3,46	9,00	10,22	0,56	2,26	2,90	2,70	10,40	13,40	1,12	1,12	1,49	3,13	3,13	4,13	4,47	10,00	11,58
1,5+1,5+2,0+4,2+5,0	0,95	0,95	1,27	2,66	3,17	3,48	9,00	10,40	0,56	2,25	2,98	2,60	10,30	13,70	1,06	1,06	1,41	2,96	3,52	4,70	10,00	11,71	
1,5+1,5+2,0+4,2+6,0	0,89	0,89	1,18	2,49	3,55	3,67	9,00	10,73	0,59	2,25	3,18	2,80	10,30	14,60	0,99	0,99	1,32	2,76	3,95	4,99	10,00	11,95	
1,5+1,5+2,0+5,0+5,0	0,90	0,90	1,20	3,00	3,00	3,69	9,00	10,66	0,59	2,21	3,12	2,80	10,20	14,30	1,00	1,00	1,33	3,33	3,33	4,93	10,00	11,84	
1,5+1,5+2,5+2,5+2,5	1,24	1,24	2,07	2,07	2,07	2,92	8,70	9,50	0,53	2,14	2,51	2,44	9,80	11,60	1,43	1,43	2,38	2,38	3,38	3,63	10,00	11,54	
1,5+1,5+2,5+2,5+3,5	1,17	1,17	1,96	1,96	2,74	3,07	9,00	9,87	0,56	2,26	2,71	2,57	10,40	12,50	1,30	1,30	2,17	2,17	3,04	3,92	10,00	11,55	
1,5+1,5+2,5+2,5+4,2	1,11	1,11	1,84	1,84	3,10	3,17	9,00	10,09	0,60	2,26	2,84	2,74	10,40	13,00	1,23	1,23	2,05	2,05	3,44	4,12	10,00	11,55	
1,5+1,5+2,5+2,5+5,0	1,04	1,04	1,73	1,73	3,46	3,29	9,00	10,39	0,60	2,25	2,98	2,74	10,30	13,70	1,15	1,15	1,92	1,92	3,85	4,36	10,00	11,69	
1,5+1,5+2,5+2,5+6,0	0,96	0,96	1,61	1,61	3,86	3,48	9,00	10,61	0,56	2,25	3,11	2,60	10,30	14,30	1,07	1,07	1,79	1,79	4,29	4,64	10,00	11,93	
1,5+1,5+2,5+2,5+7,1	0,89	0,89	1,49	1,49	4,23	3,67	9,00	10,72	0,59	2,25	3,18	2,80	10,30	14,60	0,99	0,99	1,66	1,66	4,70	4,96	10,00	11,96	
1,5+1,5+2,5+3,5+3,5	1,08	1,08	1,80	2,52	2,52	3,21	9,00	10,22	0,60	2,26	2,90	2,74	10,40	13,40	1,20	1,20	2,00	2,80	4,80	4,21	10,00	11,55	
1,5+1,5+2,5+3,5+4,2	1,02	1,02	1,70	2,39	2,86	3,46	9,00	10,22	0,56	2,26	2,90	2,70	10,40	13,40	1,14	1,14	1,89	2,65	3,18	4,41	10,00	11,56	
1,5+1,5+2,5+3,5+5,0	0,96	0,96	1,61	2,25	3,21	3,48	9,00	10,40	0,56	2,25	2,98	2,60	10,30	13,70	1,07	1,07	1,79	2,50	3,57	4,64	10,00	11,70	
1,5+1,5+2,5+3,5+6,0	0,90	0,90	1,50	2,10	3,60	3,67	9,00	10,73	0,59	2,25	3,18	2,80	10,30	14,60	1,00	1,00	1,67	2,33	4,00	4,93	10,00	11,94	
1,5+1,5+2,5+4,2+4,2	0,97	0,97	1,62	2,72	2,72	3,47	9,00	10,23	0,56	2,26	2,90	2,70	10,40	13,40	1,08	1,08	1,80	3,02	3,02	4,61	10,00	11,58	
1,5+1,5+2,5+4,2+5,0	0,92	0,92	1,53	2,57	3,06	3,67	9,00	10,72	0,59	2,25	3,18	2,80	10,30	14,60	1,02	1,02	1,70	2,86	3,40	4,85	10,00	11,71	
1,5+1,5+2,5+5,0+5,0	0,87	0,87	1,45	2,90	2,90	3,69	9,00	10,77	0,59	2,21	3,19	2,80	10,20	14,60	0,97	0,97	1,61	3,23	3,23	5,07	10,00	11,84	
1,5+1,5+3,5+3,5+3,5	1,00	1,00	2,33	2,33	2,33	3,47	9,00	10,24	0,56	2,26	2,91	2,70	10,40	13,40	1,11	1,11	2,59	2,59	2,59	4,50	10,00	11,56	
1,5+1,5+3,5+3,5+4,2	0,95	0,95	2,22	2,22	2,66	3,47	9,00	10,24	0,56	2,26	2,91	2,70	10,40	13,40	1,06	1,06	2,46	2,46	2,96	4,70	10,00	11,58	
1,5+1,5+3,5+3,5+5,0	0,90	0,90	2,10	2,10	3,00	3,67	9,00	10,73	0,59	2,25	3,18	2,80	10,30	14,60	1,00	1,00	2,33	2,33	3,33	4,93	10,00	11,71	
1,5+1,5+3,5+4,2+4,2	0,91	0,91	2,11	2,54	2,54	3,65	9,00	10,67	0,60	2,26	3,18	2,80	10,40	14,60	1,01	1,01	2,35	2,82	2,82	4,90	10,00	11,59	
1,5+2,0+2,0+2,0+2,0	1,26	1,68	1,68	1,68	1,68	2,77	8,00	8,99	0,53	1,85	2,27	2,44	8,50	10,40	1,58	2,11	2,11	2,11	2,11	3,35	10,00	11,54	
1,5+2,0+2,0+2,0+2,5	1,28	1,70	1,70	1,70	2,13	2,85	8,50	9,25	0,53	2,06	2,39	2,44	9,50	11,00	1,50	2,00	2,00	2,00	2,50	3,49	10,00	11,54	
1,5+2,0+2,0+2,0+3,5	1,23	1,64	1,64	1,64	2,86	2,99	9,00	9,74	0,56	2,26	2,64	2,57	10,40	12,10	1,36	1,82	1,82	1,82	3,18	3,77	10,00	11,55	
1,5+2,0+2,0+2,0+4,2	1,15	1,54	1,54	1,54	3,23	3,10	9,00	9,97	0,56	2,26	2,77	2,57	10,40	12,70	1,28	1,71	1,71	1,71	3,59	3,98	10,00	11,55	
1,5+2,0+2,0+2,0+5,0	1,08	1,44	1,44	1,44	3,60	3,21	9,00	10,27	0,60	2,25	2,91	2,74	10,40	13,40	1,20	1,60	1,60	1,60	4,00	4,21	10,00	11,69	
1,5+2,0+2,0+2,0+6,0	1,00	1,33	1,33	1,33	4,00	3,48	9,00	10,49	0,56	2,25	3,04	2,60	10,30	14,00	1,11	1,48	1,48	1,48	4,44	4,50	10,00	11,70	
1,5+2,0+2,0+2,0+7,1	0,92	1,23	1,23	1,23	4,38	3,67	9,00	10,71	0,59	2,25	3,18	2,80	10,30	14,60	1,03	1,37	1,37	1,37	4,86	4,81	10,00	11,71	
1,5+2,0+2,0+2,5+2,5	1,24	1,66	1,66	2,07	2,07	2,92	8,70	9,49	0,53	2,14	2,51	2,44	9,80	11,60	1,43	1,90	1,90	2,38	2,38	3,63	10,00	11,54	
1,5+2,0+2,0+2,5+3,5	1,17	1,57	1,57	1,96	2,74	3,07	9,00	9,86	0,56	2,26	2,70	2,57	10,40	12,50	1,30	1,74	1,74	2,17	3,04	3,92	10,00	11,56	
1,5+2,0+2,0+2,5+4,2	1,11	1,48	1,48	1,84	3,10	3,17	9,00	10,09	0,60	2,26	2,84	2,74	10,40	13,00	1,23	1,64	1,64	2,05	3,44	4,12	10,00	11,58	
1,5+2,0+2,0+2,5+5,0	1,04	1,38	1,38	1,73	3,46	3,29	9,00	10,38	0,60	2,25	2,98	2,74	10,40	13,70	1,15	1,54	1,54	1,92	3,85	4,36	10,00	11,71	
1,5+2,0+2,0+2,5+6,0	0,96	1,29	1,29	1,61	3,86	3,48	9,00	10,61	0,56	2,25	3,11	2,60	10,30	14,30	1,07	1,43	1,43	1,79	4,29	4,64	10,00	11,72	
1,5+2,0+2,0+2,5+7,1	0,89	1,19	1,19	1,49	4,23	3,67	9,00	10,72	0,59	2,25	3,18	2,80	10,30	14,60	0,99	1,32	1,32	1,66	4,70	4,96	10,00	11,54	
1,5+2,0+2,0+3,5+3,5	1,08	1,44	1,44	2,52	2,52	3,21	9,00	10,21	0,60	2,26	2,90	2,74	10,40	13,40	1,20	1,60	1,60	2,80	2,80	4,21	10,00	11,53	
1,5+2,0+2,0+3,5+4,2	1,02	1,36	1,36	2,39	2,86	3,46	9,00	10,22	0,56	2,26	2,90	2,70	10,40	13,40	1,14	1,52	1,52	2,65	3,18	4,41	10,00	11,55	
1,5+2,0+2,0+3,5+5,0	0,96	1,29	1,29	2,25	3,21	3,48	9,00	10,40	0,56	2,25	2,98	2,60	10,30	13,70	1,07	1,43	1,43	2,50	3,57	4,64	10,00	11,56	
1,5+2,0+2,0+3,5+6,0	0,90	1,20	1,20	2,10	3,60	3,67	9,00	10,72	0,59	2,25	3,18	2,80	10,30	14,60	1,00	1,33	1,33	2,33	4,00	4,93	10,00	11,69	
1,5+2,0+2,0+4,2+4,2	0,97	1,29	1,29	2,72	2,72	3,46	9,00	10,22	0,56	2,26	2,90	2,70	10,40	13,40	1,08	1,44	1,44	3,02	3,02	4,61	10,00	11,58	
1,5+2,0+2,0+4,2+5,0	0,92	1,22	1,22	2,57	3,06	3,67	9,00	10,72	0,59	2,25	3,18	2,80	10,30	14,60	1,02	1,36	1,36	2,86	3,40	4,85	10,00	11,71	
1,5+2,0+2,0+5,0+5,0	0,87	1,16	1,16	2,90	2,90	3,69	9,00	10,77	0,59	2,21	3,19	2,80	10,20	14,60	0,97	1,29	1,29	3,23	3,23	5,07	10,00	11,84	
1,5+2,0+2,5+2,5+2,5	1,23	1,64	2,05	2,05	2,05	2,99	9,00	9,73	0,56	2,27	2,64	2,57	10,40	12,10	1,36	1,82	2,27	2,27	2,27	3,77	10,00	11,54	
1,5+2,0+2,5+2,5+3,5	1,13	1,50	1,88	1,88	2,63	3,14	9,00	10,09	0,56	2,26	2,84	2,57	10,40	13,00	1,25	1,67	2,08	2,08	2,92	4,07	10,00	11,55	
1,5+2,0+2,5+2,5+4,2	1,06	1,42	1,77	1,77	2,98	3,24	9,00	10,20	0,60	2,26	2,90	2,74</											

Opgenomen vermogen verwarmen [kW]			Totale stroom verwarmen [A]			Vermogens-factor [%]	Seizoensgegevens koelen				Seizoensgegevens verwarmen (gemiddeld klimaat)						Seizoensgegevens verwarmen (warm klimaat)					
Min.	Nom.	Max.	Min.	Nom.	Max.		label	SEER	Ontwerp-capaciteit	AEC	label	SCOP	Ontwerp-capaciteit	AEC	Opgegeven capaciteit bij -10°C	Capaciteit back-upverwarming bij -10°C	label	SCOP	Ontwerp-capaciteit	AEC	Opgegeven capaciteit bij +2°C	Capaciteit back-upverwarming bij +2°C
0,65	2,07	2,78	2,97	9,48	12,22	95	A++	7,71	9,00	409	A+	4,45	6,46	2032	5,25	1,21	A+++	5,34	3,50	917	3,50	0
0,65	2,03	2,70	2,97	9,30	11,85	95	A++	7,73	9,00	408	A+	4,47	6,46	2022	5,26	1,20	A+++	5,34	3,60	943	3,60	0
0,71	2,02	2,68	3,27	9,25	11,76	95	A++	7,76	9,00	406	A+	4,50	6,46	2010	5,26	1,20	A+++	5,30	3,70	976	3,70	0
0,65	2,08	2,77	2,97	9,52	12,17	95	A++	7,68	9,00	410	A+	4,38	6,46	2064	5,24	1,22	A+++	5,43	3,40	877	3,40	0
0,67	2,07	2,77	3,05	9,48	12,17	95	A++	7,69	9,00	410	A+	4,39	6,46	2056	5,24	1,22	A+++	5,42	3,40	877	3,40	0
0,70	2,06	2,77	3,18	9,43	12,17	95	A++	7,72	9,00	408	A+	4,46	6,46	2024	5,26	1,20	A+++	5,35	3,60	941	3,60	0
0,70	2,02	2,69	3,18	9,25	11,81	95	A++	7,74	9,00	407	A+	4,49	6,46	2015	5,26	1,20	A+++	5,35	3,60	941	3,60	0
0,76	1,99	2,68	3,48	9,11	11,76	95	A++	7,76	9,00	406	A+	4,53	6,46	1995	5,26	1,20	A+++	5,35	3,70	968	3,70	0
0,71	2,07	2,76	3,27	9,48	12,13	95	A++	7,70	9,00	409	A+	4,41	6,46	2048	5,25	1,21	A+++	5,44	3,40	875	3,40	0
0,74	2,06	2,77	3,40	9,43	12,17	95	A++	7,73	9,00	408	A+	4,45	6,46	2028	5,26	1,20	A+++	5,37	3,60	939	3,60	0
0,74	2,05	2,69	3,40	9,39	11,81	95	A++	7,75	9,00	407	A+	4,48	6,46	2016	5,26	1,20	A+++	5,33	3,70	972	3,70	0
0,77	2,00	2,73	3,53	9,16	11,95	95	A++	7,70	9,00	410	A++	4,60	6,46	1966	5,28	1,18	A+++	5,36	3,60	939	3,60	0
0,56	2,08	2,77	2,58	9,52	12,17	95	A++	7,72	8,70	395	A+	4,36	6,46	2071	5,24	1,22	A+++	5,43	3,40	877	3,40	0
0,63	2,07	2,77	2,88	9,48	12,17	95	A++	7,67	9,00	411	A+	4,39	6,46	2057	5,24	1,22	A+++	5,42	3,40	879	3,40	0
0,65	2,07	2,77	2,97	9,48	12,17	95	A++	7,68	9,00	411	A+	4,41	6,46	2049	5,25	1,21	A+++	5,41	3,40	879	3,40	0
0,67	2,06	2,78	3,05	9,43	12,22	95	A++	7,71	9,00	409	A+	4,45	6,46	2030	5,26	1,20	A+++	5,34	3,60	943	3,60	0
0,68	2,05	2,70	3,10	9,39	11,85	95	A++	7,73	9,00	408	A+	4,48	6,46	2018	5,26	1,20	A+++	5,30	3,70	976	3,70	0
0,74	2,05	2,57	3,40	9,39	11,76	95	A++	7,75	9,00	406	A+	4,51	6,46	2006	5,27	1,19	A+++	5,27	3,70	983	3,70	0
0,67	2,07	2,77	3,05	9,48	12,17	95	A++	7,68	9,00	410	A+	4,41	6,46	2048	5,25	1,21	A+++	5,43	3,40	877	3,40	0
0,71	2,07	2,77	3,27	9,48	12,17	95	A++	7,69	9,00	410	A+	4,43	6,46	2041	5,25	1,21	A+++	5,42	3,50	903	3,50	0
0,71	2,05	2,77	3,27	9,39	12,17	95	A++	7,72	9,00	408	A+	4,47	6,46	2023	5,26	1,20	A+++	5,35	3,60	941	3,60	0
0,74	2,05	2,69	3,40	9,39	11,81	95	A++	7,74	9,00	407	A+	4,49	6,46	2011	5,27	1,19	A+++	5,32	3,70	974	3,70	0
0,74	2,06	2,75	3,40	9,43	12,13	95	A++	7,70	9,00	410	A+	4,44	6,46	2033	5,26	1,20	A+++	5,43	3,50	901	3,50	0
0,77	2,05	2,77	3,53	9,39	12,17	95	A++	7,73	9,00	408	A+	4,48	6,46	2016	5,27	1,19	A+++	5,37	3,60	939	3,60	0
0,79	2,00	2,73	3,61	9,16	11,95	95	A++	7,67	9,00	411	A++	4,60	6,46	1964	5,27	1,19	A+++	5,38	3,60	937	3,60	0
0,71	2,05	2,77	3,27	9,39	12,17	95	A++	7,69	9,00	410	A+	4,48	6,46	2018	5,25	1,21	A+++	5,46	3,50	897	3,50	0
0,76	2,04	2,76	3,48	9,34	12,13	95	A++	7,70	9,00	410	A+	4,49	6,46	2011	5,26	1,20	A+++	5,46	3,50	897	3,50	0
0,79	2,03	2,77	3,61	9,30	12,17	95	A++	7,73	9,00	408	A+	4,53	6,46	1994	5,27	1,19	A+++	5,39	3,60	935	3,60	0
0,82	2,04	2,76	3,74	9,34	12,13	95	A++	7,71	9,00	409	A+	4,51	6,46	2003	5,26	1,20	A+++	5,47	3,50	896	3,50	0
0,52	2,07	2,77	2,37	9,48	12,17	95	A++	7,81	8,00	359	A+	4,40	6,46	2056	5,24	1,22	A+++	5,43	3,40	877	3,40	0
0,55	2,07	2,77	2,50	9,48	12,17	95	A++	7,83	8,50	380	A+	4,41	6,46	2048	5,25	1,21	A+++	5,42	3,40	877	3,40	0
0,58	2,06	2,77	2,67	9,43	12,17	95	A++	7,67	9,00	411	A+	4,44	6,46	2034	5,26	1,20	A+++	5,41	3,50	905	3,50	0
0,62	2,06	2,77	2,84	9,43	12,17	95	A++	7,68	9,00	411	A+	4,46	6,46	2027	5,26	1,20	A+++	5,41	3,50	906	3,50	0
0,65	2,05	2,78	2,97	9,39	12,22	95	A++	7,71	9,00	409	A+	4,49	6,46	2011	5,27	1,19	A+++	5,34	3,70	970	3,70	0
0,65	2,04	2,65	2,97	9,34	12,13	95	A++	7,73	9,00	408	A+	4,52	6,46	1999	5,27	1,19	A+++	5,30	3,70	977	3,70	0
0,71	2,00	2,66	3,27	9,16	12,17	95	A++	7,76	9,00	406	A++	4,60	6,46	1964	5,29	1,17	A+++	5,30	3,80	1003	3,80	0
0,56	2,07	2,61	2,58	9,48	11,95	95	A++	7,86	8,70	388	A+	4,43	6,46	2040	5,25	1,21	A+++	5,43	3,50	902	3,50	0
0,63	2,06	2,66	2,88	9,43	12,17	95	A++	7,90	9,00	399	A+	4,46	6,46	2026	5,26	1,20	A+++	5,42	3,50	903	3,50	0
0,65	2,05	2,65	2,97	9,39	12,13	95	A++	7,90	9,00	399	A+	4,48	6,46	2019	5,26	1,20	A+++	5,42	3,60	930	3,60	0
0,67	2,04	2,66	3,05	9,34	12,17	95	A++	7,93	9,00	397	A+	4,51	6,46	2005	5,27	1,19	A+++	5,35	3,70	968	3,70	0
0,68	2,04	2,65	3,10	9,34	12,13	95	A++	7,95	9,00	396	A+	4,53	6,46	1993	5,28	1,18	A+++	5,31	3,80	1001	3,80	0
0,74	2,00	2,66	3,40	9,16	12,17	95	A++	7,97	9,00	395	A++	4,62	6,46	1958	5,29	1,17	A+++	5,31	3,80	1001	3,80	0
0,67	2,05	2,66	3,05	9,39	12,17	95	A++	7,91	9,00	399	A+	4,48	6,46	2018	5,26	1,20	A+++	5,43	3,60	927	3,60	0
0,71	2,05	2,66	3,27	9,39	12,17	95	A++	7,91	9,00	398	A+	4,47	6,46	2023	5,27	1,19	A+++	5,43	3,60	928	3,60	0
0,71	2,04	2,66	3,27	9,34	12,22	95	A++	7,94	9,00	397	A+	4,52	6,46	1998	5,28	1,18	A+++	5,36	3,70	966	3,70	0
0,74	2,00	2,67	3,40	9,16	12,13	95	A++	7,96	9,00	396	A++	4,60	6,46	1963	5,30	1,16	A+++	5,36	3,80	992	3,80	0
0,74	2,05	2,76	3,40	9,39	12,17	95	A++	7,92	9,00	398	A+	4,48	6,46	2016	5,27	1,19	A+++	5,44	3,60	926	3,60	0
0,77	2,03	2,77	3,53	9,30	11,95	95	A++	7,95	9,00	396	A+	4,54	6,46	1991	5,28	1,18	A+++	5,37	3,80	990	3,80	0
0,79	2,00	2,73	3,61	9,16	12,17	95	A++	7,95	9,00	396	A++	4,63	6,46	1954	5,30	1,16	A+++	5,38	3,80	989	3,80	0
0,58	2,07	2,77	2,67	9,48	12,17	95	A++	7,89	9,00	399	A+	4,43	6,46	2041	5,25	1,21	A+++	5,43	3,50	903	3,50	0
0,65	2,06	2,77	2,97	9,43	12,17	95	A++	7,91	9,00	399	A+	4,46	6,46	2027	5,26	1,20	A+++	5,41	3,50	905	3,50	0
0,67	2,05	2,77	3,05	9,39	12,17	95	A++	7,91	9,00	398	A+	4,47	6,46	2020	5,26	1,20	A+++	5,41	3,60	931	3,60	0
0,70	2,04	2,78	3,18	9,34	12,22	95	A++	7,94	9,00	397	A+	4,51	6,46	2005	5,27	1,19	A+++	5,34	3,70	970	3,70	0
0,70	2,04	2,70	3,18	9,34	11,85	95	A++	7,96	9,00	396	A+	4,53	6,46	1993	5,28	1,18	A+++	5,30	3,80	1003	3,80	0
0,77	2,00	2,68	3,53	9,16	11,76	95	A++	7,98	9,00	395	A++	4,61	6,46	1959	5,28	1,18	A+++	5,30	3,80	1002	3,80	0
0,70	2,05	2,77	3,18	9,39	12,17	95	A++	7,92	9,00	398	A+	4,48	6,46	2019	5,26	1,20	A+++	5,42	3,60	929	3,60	0
0,74	2,05	2,77	3,40	9,39	12,17	95	A++	7,92	9,00	398	A+	4,47	6,46	2024	5,27	1,19	A+++	5,42	3,60	929	3,60	0
0,77	2,04	2,77	3,53	9,34	12,17	95	A++	7,95	9,00	396	A+	4,52	6,46	1998	5,28	1,18	A+++	5,35	3,70	967	3,70	0
0,77	2,00	2,69	3,53	9,16	12,17	95	A++	7,97	9,00	396	A++	4,61	6,46	1962	5,30	1,16	A+++	5,36	3,80	992	3,80	0
0,76	2,05	2,76	3,48	9,39	12,13	95	A++	7,93	9,00	398	A+	4,48	6,46	2017	5,27	1,19	A+++	5,43	3,60	927	3,60	0
0,79	1,99	2,77	3,61	9,11	12,17	95	A++	7,96	9,00	396	A++	4,63	6,46	1950	5,28	1,18	A+++	5,42	3,80	981	3,80	0
0,77	2,05	2,77	3,53	9,39	12,17	95	A++	7,93	9,00	398	A+	4,49	6,46	2012	5,27	1,19						

Combinatietabellen

Binneneunit	Koelcapaciteit [kW]					Totale koelcapaciteit [kW]			Opgenomen vermogen koelen [kW]			Totale stroom koelen [A]			Verwarmingcapaciteit [kW]					Totale verwarmingcapaciteit [kW]		
	Kamer A	Kamer B	Kamer C	Kamer D	Kamer E	Min.	Nom.	Max.	Min.	Nom.	Max.	Min.	Nom.	Max.	Kamer A	Kamer B	Kamer C	Kamer D	Kamer E	Min.	Nom.	Max.
1,5+2,5+2,5+3,5+3,5	1,00	1,67	1,67	2,33	2,33	3,46	9,00	10,22	0,56	2,26	2,90	2,70	10,40	13,40	1,11	1,85	1,85	2,59	2,59	4,50	10,00	11,55
1,5+2,5+2,5+3,5+4,2	0,95	1,58	1,58	2,22	2,66	3,47	9,00	10,23	0,56	2,26	2,90	2,70	10,40	13,40	1,06	1,76	1,76	2,46	2,96	4,70	10,00	11,56
1,5+2,5+2,5+3,5+5,0	0,90	1,50	1,50	2,10	3,00	3,67	9,00	10,72	0,59	2,25	3,18	2,80	10,30	14,60	1,00	1,67	1,67	2,33	3,33	4,93	10,00	11,70
1,5+2,5+2,5+4,2+4,2	0,91	1,51	1,51	2,54	2,54	3,65	9,00	10,66	0,60	2,26	3,18	2,80	10,40	14,60	1,01	1,68	1,68	2,82	2,82	4,90	10,00	11,58
1,5+2,5+3,5+3,5+3,5	0,93	1,55	2,17	2,17	2,17	3,65	9,00	10,24	0,60	2,26	2,91	2,80	10,40	13,40	1,03	1,72	2,41	2,41	2,41	4,78	10,00	11,56
1,5+2,5+3,5+3,5+4,2	0,89	1,48	2,07	2,07	2,49	3,65	9,00	10,77	0,60	2,25	3,25	2,80	10,40	14,90	0,99	1,64	2,30	2,30	2,76	4,99	10,00	11,58
1,5+3,5+3,5+3,5+3,5	0,87	2,03	2,03	2,03	2,03	3,66	9,00	10,79	0,60	2,25	3,25	2,80	10,40	15,00	0,97	2,26	2,26	2,26	2,26	5,07	10,00	11,58
2,0+2,0+2,0+2,0+2,0	1,70	1,70	1,70	1,70	1,70	2,85	8,50	9,24	0,53	2,06	2,39	2,44	9,50	11,00	2,00	2,00	2,00	2,00	2,00	3,49	10,00	11,54
2,0+2,0+2,0+2,0+2,5	1,66	1,66	1,66	1,66	2,07	2,92	8,70	9,49	0,53	2,14	2,51	2,44	9,80	11,60	1,90	1,90	1,90	1,90	2,38	3,63	10,00	11,54
2,0+2,0+2,0+2,0+3,5	1,57	1,57	1,57	1,57	2,74	3,07	9,00	9,85	0,56	2,26	2,70	2,57	10,40	12,50	1,74	1,74	1,74	1,74	3,04	3,92	10,00	11,55
2,0+2,0+2,0+2,0+4,2	1,48	1,48	1,48	1,48	3,10	3,17	9,00	10,08	0,60	2,26	2,84	2,74	10,40	13,00	1,64	1,64	1,64	1,64	3,44	4,12	10,00	11,55
2,0+2,0+2,0+2,0+5,0	1,38	1,38	1,38	1,38	3,46	3,29	9,00	10,38	0,60	2,25	2,98	2,74	10,40	13,70	1,54	1,54	1,54	1,54	3,85	4,36	10,00	11,69
2,0+2,0+2,0+2,0+6,0	1,29	1,29	1,29	1,29	3,86	3,48	9,00	10,60	0,56	2,25	3,11	2,60	10,30	14,30	1,43	1,43	1,43	1,43	4,29	4,64	10,00	11,93
2,0+2,0+2,0+2,0+7,1	1,19	1,19	1,19	1,19	4,23	3,67	9,00	10,71	0,59	2,25	3,18	2,80	10,30	14,60	1,32	1,32	1,32	1,32	4,70	4,96	10,00	11,96
2,0+2,0+2,0+2,5+2,5	1,64	1,64	1,64	2,05	2,05	2,99	9,00	9,73	0,56	2,27	2,64	2,57	10,40	12,10	1,82	1,82	1,82	2,27	2,27	3,77	10,00	11,54
2,0+2,0+2,0+2,5+3,5	1,50	1,50	1,50	1,88	2,63	3,14	9,00	10,08	0,56	2,26	2,84	2,57	10,40	13,00	1,67	1,67	1,67	2,08	2,92	4,07	10,00	11,55
2,0+2,0+2,0+2,5+4,2	1,42	1,42	1,42	1,77	2,98	3,24	9,00	10,20	0,60	2,26	2,90	2,74	10,40	13,40	1,57	1,57	1,57	1,97	3,31	4,26	10,00	11,55
2,0+2,0+2,0+2,5+5,0	1,33	1,33	1,33	1,67	3,33	3,48	9,00	10,38	0,56	2,25	2,98	2,60	10,40	13,70	1,48	1,48	1,48	1,85	3,70	4,50	10,00	11,69
2,0+2,0+2,0+2,5+6,0	1,24	1,24	1,24	1,55	3,72	3,67	9,00	10,61	0,59	2,25	3,11	2,80	10,30	14,30	1,38	1,38	1,38	1,72	4,14	4,78	10,00	11,93
2,0+2,0+2,0+2,5+7,1	1,15	1,15	1,15	1,44	4,10	3,67	9,00	10,72	0,59	2,25	3,18	2,80	10,30	14,60	1,28	1,28	1,28	1,60	4,55	5,10	10,00	11,96
2,0+2,0+2,0+3,5+3,5	1,38	1,38	1,38	2,42	2,42	2,99	9,00	9,65	0,56	2,26	2,58	2,57	10,40	11,90	1,54	1,54	1,54	2,69	2,69	3,77	10,00	11,54
2,0+2,0+2,0+3,5+4,2	1,31	1,31	1,31	2,30	2,76	3,46	9,00	10,22	0,56	2,26	2,90	2,70	10,40	13,40	1,46	1,46	1,46	2,55	3,07	4,55	10,00	11,56
2,0+2,0+2,0+3,5+5,0	1,24	1,24	1,24	2,17	3,10	3,67	9,00	10,40	0,59	2,25	2,98	2,80	10,30	13,70	1,38	1,38	1,38	2,41	3,45	4,78	10,00	11,70
2,0+2,0+2,0+3,5+6,0	1,16	1,16	1,16	2,03	3,48	3,67	9,00	10,72	0,59	2,25	3,18	2,80	10,30	14,60	1,29	1,29	1,29	2,26	3,87	5,07	10,00	11,94
2,0+2,0+2,0+4,2+4,2	1,25	1,25	1,25	2,63	2,63	3,65	9,00	10,22	0,60	2,26	2,90	2,80	10,40	13,40	1,39	1,39	1,39	2,92	2,92	4,75	10,00	11,58
2,0+2,0+2,0+4,2+5,0	1,18	1,18	1,18	2,49	2,96	3,67	9,00	10,72	0,59	2,25	3,18	2,80	10,30	14,60	1,32	1,32	1,32	2,76	3,29	4,99	10,00	11,71
2,0+2,0+2,5+2,5+2,5	1,57	1,57	1,96	1,96	1,96	3,07	9,00	9,85	0,56	2,27	2,70	2,57	10,40	12,50	1,74	1,74	2,17	2,17	2,17	3,92	10,00	11,54
2,0+2,0+2,5+2,5+3,5	1,44	1,44	1,80	1,80	2,52	3,21	9,00	10,20	0,60	2,26	2,90	2,74	10,40	13,40	1,60	1,60	2,00	2,00	2,80	4,21	10,00	11,55
2,0+2,0+2,5+2,5+4,2	1,36	1,36	1,70	1,70	2,86	3,46	9,00	10,25	0,56	2,26	2,81	2,70	10,40	12,86	1,52	1,52	1,89	1,89	3,18	4,41	10,00	11,55
2,0+2,0+2,5+2,5+5,0	1,29	1,29	1,61	1,61	3,21	3,48	9,00	10,39	0,56	2,25	2,98	2,60	10,30	13,70	1,43	1,43	1,79	1,79	3,57	4,64	10,00	11,69
2,0+2,0+2,5+2,5+6,0	1,20	1,20	1,50	1,50	3,60	3,67	9,00	10,71	0,59	2,25	3,18	2,80	10,30	14,60	1,33	1,33	1,67	1,67	4,00	4,93	10,00	11,93
2,0+2,0+2,5+3,5+3,5	1,33	1,33	1,67	2,33	2,33	3,46	9,00	10,22	0,56	2,26	2,90	2,70	10,40	13,40	1,48	1,48	1,85	2,59	2,59	4,50	10,00	11,55
2,0+2,0+2,5+3,5+4,2	1,27	1,27	1,58	2,22	2,66	3,46	9,00	10,32	0,56	2,26	2,83	2,70	10,40	12,93	1,41	1,41	1,76	2,46	2,96	4,70	10,00	11,56
2,0+2,0+2,5+3,5+5,0	1,20	1,20	1,50	2,10	3,00	3,67	9,00	10,72	0,59	2,25	3,18	2,80	10,30	14,60	1,33	1,33	1,67	2,33	3,33	4,93	10,00	11,70
2,0+2,0+2,5+4,2+4,2	1,21	1,21	1,51	2,54	2,54	3,65	9,00	10,65	0,60	2,26	3,18	2,80	10,40	14,60	1,34	1,34	1,68	2,82	2,82	4,90	10,00	11,58
2,0+2,0+3,5+3,5+3,5	1,24	1,24	2,17	2,17	2,17	3,65	9,00	10,24	0,60	2,26	2,91	2,80	10,40	13,40	1,38	1,38	2,41	2,41	2,41	4,78	10,00	11,56
2,0+2,0+3,5+3,5+4,2	1,18	1,18	2,07	2,07	2,49	3,65	9,00	10,77	0,60	2,26	3,25	2,80	10,40	14,90	1,32	1,32	2,30	2,30	2,76	4,99	10,00	11,58
2,0+2,5+2,5+2,5+2,5	1,50	1,88	1,88	1,88	1,88	3,14	9,00	10,08	0,56	2,26	2,83	2,57	10,40	13,00	1,67	2,08	2,08	2,08	2,08	4,07	10,00	11,54
2,0+2,5+2,5+2,5+3,5	1,38	1,73	1,73	1,73	2,42	3,46	9,00	10,21	0,56	2,26	2,90	2,70	10,40	13,40	1,54	1,92	1,92	1,92	2,69	4,36	10,00	11,55
2,0+2,5+2,5+2,5+4,2	1,31	1,64	1,64	1,64	2,76	3,46	9,00	10,21	0,56	2,26	2,90	2,70	10,40	13,40	1,46	1,82	1,82	1,82	3,07	4,55	10,00	11,55
2,0+2,5+2,5+2,5+5,0	1,24	1,55	1,55	1,55	3,10	3,67	9,00	10,39	0,59	2,25	2,98	2,80	10,30	13,70	1,38	1,72	1,72	1,72	3,45	4,78	10,00	11,69
2,0+2,5+2,5+2,5+6,0	1,16	1,45	1,45	1,45	3,48	3,67	9,00	10,72	0,59	2,25	3,18	2,80	10,30	14,60	1,29	1,61	1,61	1,61	3,87	5,07	10,00	11,93
2,0+2,5+2,5+3,5+3,5	1,29	1,61	1,61	2,25	2,25	3,46	9,00	10,22	0,56	2,26	2,90	2,70	10,40	13,40	1,43	1,79	1,79	2,50	2,50	4,64	10,00	11,55
2,0+2,5+2,5+3,5+4,2	1,22	1,53	1,53	2,14	2,57	3,65	9,00	10,65	0,60	2,26	3,18	2,80	10,40	14,60	1,36	1,70	1,70	2,38	2,86	4,85	10,00	11,56
2,0+2,5+2,5+3,5+5,0	1,16	1,45	1,45	2,03	2,90	3,67	9,00	10,72	0,59	2,25	3,18	2,80	10,30	14,60	1,29	1,61	1,61	2,26	3,23	5,07	10,00	11,70
2,0+2,5+2,5+4,2+4,2	1,17	1,46	1,46	2,45	2,45	3,65	9,00	10,76	0,60	2,26	3,25	2,80	10,40	14,90	1,30	1,62	1,62	2,73	2,73	5,04	10,00	11,58
2,0+2,5+3,5+3,5+3,5	1,20	1,50	2,10	2,10	2,10	3,65	9,00	10,67	0,60	2,26	3,18	2,80	10,40	14,60	1,33	1,67	2,33	2,33	2,33	4,93	10,00	11,56
2,5+2,5+2,5+2,5+2,5	1,80	1,80	1,80	1,80	1,80	3,21	9,00	10,19	0,60	2,26	2,90	2,74	10,40	13,40	2,00	2,00	2,00	2,00	2,00	4,21	10,00	11,54
2,5+2,5+2,5+2,5+3,5	1,67	1,67	1,67	1,67	2,33	3,46	9,00	10,21	0,56	2,26	2,90	2,70	10,40	13,40	1,85	1,85	1,85	1,85	2,59	4,50	10,00	11,55
2,5+2,5+2,5+2,5+4,2	1,58	1,58	1,58	1,58	2,66	3,46	9,00	10,22	0,56	2,26	2,90	2,70	10,40	13,40	1,76	1,76	1,76	1,76	2,96	4,70	10,00	11,55
2,5+2,5+2,5+2,5+5,0	1,50	1,50	1,50	1,50	3,00	3,67	9,00	10,71	0,59	2,25	3,18	2,80	10,30	14,60	1,67	1,67	1,67	1,67	3,33	4,93	10,00	11,69
2,5+2,5+2,5+3,5+3,5	1,55	1,55	1,55	2,17	2,17	3,65	9,00	10,23	0,60	2,26	2,90	2,80	10,40									

Opgenomen vermogen verwarmen [kW]			Totale stroom verwarmen [A]			Vermogens-factor [%]	Seizoensgegevens koelen				Seizoensgegevens verwarmen (gemiddeld klimaat)						Seizoensgegevens verwarmen (warm klimaat)					
Min.	Nom.	Max.	Min.	Nom.	Max.		label	SEER	Ontwerp-capaciteit	AEC	label	SCOP	Ontwerp-capaciteit	AEC	Opgegeven capaciteit bij -10°C	Capaciteit back-upverwarming bij -10°C	label	SCOP	Ontwerp-capaciteit	AEC	Opgegeven capaciteit bij +2°C	Capaciteit back-upverwarming bij +2°C
0,71	2,03	2,77	3,27	9,30	12,17	95	A++	7,90	9,00	399	A+	4,49	6,46	2013	5,27	1,19	A+++	5,45	3,60	925	3,60	0
0,77	2,02	2,77	3,53	9,25	12,17	95	A++	7,90	9,00	399	A+	4,50	6,46	2007	5,27	1,19	A+++	5,44	3,60	926	3,60	0
0,79	1,97	2,77	3,61	9,02	12,17	95	A++	7,93	9,00	397	A++	4,62	6,46	1957	5,29	1,17	A+++	5,42	3,80	981	3,80	0
0,82	2,02	2,76	3,74	9,25	12,13	95	A++	7,91	9,00	398	A+	4,52	6,46	2000	5,28	1,18	A+++	5,45	3,70	950	3,70	0
0,79	2,02	2,77	3,61	9,25	12,17	95	A++	7,91	9,00	399	A+	4,51	6,46	2006	5,27	1,19	A+++	5,46	3,60	923	3,60	0
0,82	2,02	2,76	3,74	9,25	12,13	95	A++	7,91	9,00	398	A+	4,52	6,46	2000	5,28	1,18	A+++	5,45	3,70	950	3,70	0
0,85	2,00	2,76	3,87	9,16	12,13	95	A++	7,92	9,00	398	A+	4,56	6,46	1981	5,29	1,17	A+++	5,46	3,70	948	3,70	0
0,55	2,05	2,77	2,50	9,39	12,17	95	A++	7,83	8,50	380	A+	4,47	6,46	2023	5,27	1,19	A+++	5,42	3,60	929	3,60	0
0,56	2,05	2,77	2,58	9,39	12,17	95	A++	7,72	8,70	395	A+	4,48	6,46	2017	5,27	1,19	A+++	5,42	3,60	929	3,60	0
0,63	2,04	2,77	2,88	9,34	12,17	95	A++	7,86	9,00	401	A+	4,51	6,46	2006	5,28	1,18	A+++	5,41	3,70	957	3,70	0
0,65	2,03	2,77	2,97	9,30	12,17	95	A++	7,86	9,00	401	A+	4,52	6,46	2000	5,28	1,18	A+++	5,40	3,70	958	3,70	0
0,67	2,00	2,78	3,05	9,16	12,22	95	A++	7,89	9,00	399	A++	4,61	6,46	1959	5,29	1,17	A+++	5,36	3,80	992	3,80	0
0,68	1,99	2,70	3,10	9,11	11,85	95	A++	7,91	9,00	399	A++	4,64	6,46	1948	5,30	1,16	A+++	5,32	3,90	1025	3,90	0
0,74	1,99	2,68	3,40	9,11	11,76	95	A++	7,93	9,00	398	A++	4,66	6,46	1937	5,30	1,16	A+++	5,28	4,00	1059	4,00	0
0,58	2,04	2,77	2,67	9,34	12,17	95	A++	7,76	9,00	406	A+	4,49	6,46	2010	5,27	1,19	A+++	5,43	3,60	927	3,60	0
0,65	2,03	2,77	2,97	9,30	12,17	95	A++	7,77	9,00	405	A+	4,52	6,46	1999	5,28	1,18	A+++	5,42	3,70	955	3,70	0
0,67	2,03	2,77	3,05	9,30	12,17	95	A++	7,78	9,00	405	A+	4,53	6,46	1993	5,29	1,17	A+++	5,42	3,70	956	3,70	0
0,70	1,99	2,78	3,18	9,11	12,22	95	A++	7,81	9,00	404	A++	4,62	6,46	1955	5,30	1,16	A+++	5,33	3,90	1024	3,90	0
0,70	1,99	2,70	3,18	9,11	11,85	95	A++	7,83	9,00	403	A++	4,65	6,46	1944	5,30	1,16	A+++	5,29	3,90	1032	3,90	0
0,77	1,98	2,68	3,53	9,07	11,76	95	A++	7,85	9,00	401	A++	4,67	6,46	1933	5,30	1,16	A+++	5,25	4,00	1066	4,00	0
0,58	2,03	2,77	2,67	9,30	12,17	95	A++	7,78	9,00	405	A+	4,54	6,46	1992	5,29	1,17	A+++	5,43	3,70	953	3,70	0
0,74	2,03	2,77	3,40	9,30	12,17	95	A++	7,79	9,00	405	A+	4,55	6,46	1986	5,29	1,17	A+++	5,43	3,80	980	3,80	0
0,77	1,99	2,77	3,53	9,11	12,17	95	A++	7,82	9,00	403	A++	4,65	6,46	1941	5,30	1,16	A+++	5,39	3,90	1013	3,90	0
0,77	1,99	2,69	3,53	9,11	11,81	95	A++	7,84	9,00	402	A++	4,68	6,46	1931	5,30	1,16	A+++	5,35	4,00	1047	4,00	0
0,76	2,02	2,76	3,48	9,25	12,13	95	A++	7,80	9,00	404	A++	4,61	6,46	1961	5,29	1,17	A+++	5,44	3,80	977	3,80	0
0,79	2,01	2,83	3,61	9,20	12,40	95	A++	7,83	9,00	403	A++	4,66	6,46	1938	5,30	1,16	A+++	5,37	3,90	1016	3,90	0
0,63	2,04	2,77	2,88	9,34	12,17	95	A++	7,74	9,00	407	A+	4,49	6,46	2011	5,27	1,19	A+++	5,43	3,60	929	3,60	0
0,67	2,03	2,77	3,05	9,30	12,17	95	A++	7,76	9,00	406	A+	4,52	6,46	1999	5,28	1,18	A+++	5,41	3,70	957	3,70	0
0,70	2,03	2,77	3,18	9,30	12,17	95	A++	7,76	9,00	406	A+	4,53	6,46	1993	5,29	1,17	A+++	5,41	3,70	957	3,70	0
0,71	1,99	2,78	3,27	9,11	12,22	95	A++	7,79	9,00	404	A++	4,63	6,46	1953	5,30	1,16	A+++	5,37	3,90	1017	3,90	0
0,75	1,99	2,70	3,44	9,11	11,85	95	A++	7,81	9,00	403	A++	4,65	6,46	1942	5,30	1,16	A+++	5,33	3,90	1024	3,90	0
0,71	1,99	2,77	3,27	9,11	12,17	95	A++	7,77	9,00	406	A++	4,60	6,46	1963	5,29	1,17	A+++	5,47	3,70	946	3,70	0
0,77	1,99	2,77	3,53	9,11	12,17	95	A++	7,77	9,00	406	A++	4,62	6,46	1957	5,29	1,17	A+++	5,47	3,80	972	3,80	0
0,79	1,98	2,77	3,61	9,07	12,17	95	A++	7,80	9,00	404	A++	4,67	6,46	1934	5,30	1,16	A+++	5,40	3,90	1011	3,90	0
0,82	1,99	2,82	3,74	9,11	12,36	95	A++	7,78	9,00	405	A++	4,63	6,46	1951	5,29	1,17	A+++	5,48	3,80	970	3,80	0
0,79	1,99	2,77	3,61	9,11	12,17	95	A++	7,77	9,00	405	A++	4,62	6,46	1957	5,29	1,17	A+++	5,48	3,80	970	3,80	0
0,82	1,99	2,82	3,74	9,11	12,36	95	A++	7,78	9,00	405	A++	4,63	6,46	1951	5,29	1,17	A+++	5,48	3,80	970	3,80	0
0,65	2,03	2,77	2,97	9,30	12,17	95	A++	7,75	9,00	407	A+	4,52	6,46	1999	5,28	1,18	A+++	5,42	3,70	955	3,70	0
0,70	2,03	2,77	3,18	9,30	12,17	95	A++	7,76	9,00	406	A+	4,55	6,46	1987	5,29	1,17	A+++	5,41	3,80	983	3,80	0
0,74	2,02	2,77	3,40	9,25	12,17	95	A++	7,76	9,00	406	A+	4,56	6,46	1981	5,29	1,17	A+++	5,41	3,80	983	3,80	0
0,77	1,99	2,78	3,53	9,11	12,22	95	A++	7,80	9,00	404	A++	4,65	6,46	1942	5,30	1,16	A+++	5,37	3,90	1017	3,90	0
0,77	1,98	2,70	3,53	9,07	11,85	95	A++	7,82	9,00	403	A++	4,68	6,46	1931	5,31	1,15	A+++	5,33	4,00	1050	4,00	0
0,77	1,99	2,77	3,53	9,11	12,17	95	A++	7,77	9,00	406	A++	4,60	6,46	1963	5,29	1,17	A+++	5,46	3,80	974	3,80	0
0,79	1,99	2,77	3,61	9,11	12,17	95	A++	7,77	9,00	405	A++	4,62	6,46	1957	5,30	1,16	A+++	5,46	3,80	975	3,80	0
0,82	1,98	2,77	3,74	9,07	12,17	95	A++	7,83	9,00	403	A++	4,67	6,46	1934	5,31	1,15	A+++	5,38	4,00	1040	4,00	0
0,85	1,99	2,82	3,87	9,11	12,36	95	A++	7,77	9,00	406	A++	4,63	6,46	1951	5,30	1,16	A+++	5,47	3,80	972	3,80	0
0,82	1,99	2,77	3,74	9,11	12,17	95	A++	7,78	9,00	405	A++	4,62	6,46	1957	5,30	1,16	A+++	5,47	3,80	972	3,80	0
0,68	2,03	2,77	3,10	9,30	12,17	95	A++	7,73	9,00	408	A+	4,55	6,46	1987	5,29	1,17	A+++	5,42	3,80	981	3,80	0
0,72	2,02	2,66	3,31	9,25	12,17	95	A++	7,74	9,00	407	A+	4,57	6,46	1975	5,30	1,16	A+++	5,41	3,80	983	3,80	0
0,77	2,02	2,66	3,53	9,25	12,17	95	A++	7,75	9,00	407	A+	4,59	6,46	1970	5,30	1,16	A+++	5,41	3,80	983	3,80	0
0,80	2,00	2,67	3,66	9,16	12,22	95	A++	7,75	9,00	407	A++	4,64	6,46	1946	5,31	1,15	A+++	5,34	4,00	1049	4,00	0
0,80	2,02	2,66	3,66	9,25	12,17	95	A++	7,76	9,00	406	A++	4,60	6,46	1965	5,30	1,16	A+++	5,42	3,80	981	3,80	0
0,82	2,01	2,66	3,74	9,20	12,17	95	A++	7,76	9,00	406	A++	4,61	6,46	1959	5,30	1,16	A+++	5,42	3,90	1007	3,90	0
0,85	1,99	2,66	3,87	9,11	12,17	95	A++	7,77	9,00	406	A++	4,66	6,46	1940	5,32	1,14	A+++	5,43	3,90	1005	3,90	0

